

PCE Americas Inc.  
711 Commerce Way  
Suite 8  
Jupiter  
FL-33458  
USA

From outside US: +1  
Tel: (561) 320-9162  
Fax: (561) 320-9176  
info@pce-americas.com

PCE Instruments UK Ltd.  
Units 12/13  
Southpoint Business Park  
Ensign way  
Hampshire / Southampton  
United Kingdom, SO31 4RF

From outside UK: +44  
Tel: (0) 2380 98703 0  
Fax: (0) 2380 98703 9  
info@pce-instruments.com

[www.pce-instruments.com/english](http://www.pce-instruments.com/english)  
[www.pce-instruments.com](http://www.pce-instruments.com)

## Manual AC/DC Clamp Meter PCE-DC 41



Version 1.1  
Date of creation: 07.07.2015  
Date of last change: 05.08.2015

## Content

<b>1</b>	<b>Introduction .....</b>	<b>3</b>
<b>2</b>	<b>Safety notes .....</b>	<b>3</b>
2.1	Warning symbols .....	3
2.2	Safety instructions .....	3
<b>3</b>	<b>Specifications .....</b>	<b>4</b>
3.1	General .....	4
3.2	Electrical .....	5
<b>4</b>	<b>System description .....</b>	<b>6</b>
4.1	Display .....	6
4.2	Front and rear .....	7
4.3	Key functions .....	7
4.3.1	HOLD function .....	7
4.3.2	PEAK function .....	7
4.3.3	Zero function .....	7
4.3.4	Backlight function .....	7
<b>5</b>	<b>Instructions .....</b>	<b>8</b>
5.1	Measurement .....	8
5.1.1	AC voltage measurement .....	8
5.1.2	DC voltage measurement .....	8
5.1.3	AC current measurement .....	9
5.1.4	DC current measurement .....	9
5.1.5	Resistance measurement .....	10
5.1.6	Continuity test with buzzer .....	10
5.2	Battery replacement .....	11
5.3	Maintenance .....	11
5.4	Cleaning .....	11
<b>6</b>	<b>Contact .....</b>	<b>12</b>
6.1	PCE Instruments UK .....	12
6.2	PCE Americas .....	12

## 1 Introduction

Thank you for purchasing a PCE-DC 41 from PCE Instruments.

This instrument is highly versatile in power system maintenance as it has several functions. It is not only very reliable in measuring power, it can also measure voltage, current and continuity at high accuracy. Measurement results are easily readable from the 4-digit LC display with backlight. The device's special features are its Peak Hold and Data Hold functions, its Auto Zero function as well as an Auto Power Off function which turns off the meter after 30 minutes of inactivity. The instrument comes with batteries, a test lead, a carrying case and an instruction manual.

## 2 Safety notes

### 2.1 Warning symbols



Attention! Please refer to instruction manual.



Dangerous voltage may be present at terminals.



Double insulation.

Approvals:  EN61010 600V CAT III

### 2.2 Safety instructions

Please read this manual carefully and completely before you use the device for the first time. The device may only be used by qualified personnel and repaired by PCE Instruments personnel. There is no warranty of damages or injuries caused by non-observance of the manual.

- The device may only be used in the approved temperature and humidity range.  
Operating conditions: 0 ... 40 °C (32 ... 104 °F); <70 % RH  
Storage conditions: -10 ... 60 °C (14 ... 140 °F); <80 % RH
- Inspect the device as well as the test leads before each use. If there is any visible damage, do not use the device.
- Make sure that the main function dial is in the correct position before each measurement.
- Do not carry out any resistance or continuity tests on a live power system.
- Do not apply voltage between the test terminals or a test terminal to ground exceeding the maximum limit as specified in this manual.
- Keep your fingers behind the protection ring when using the test lead for measurement.
- To ensure high accuracy, replace the battery whenever the  icon appears.
- The case should only be opened by qualified personnel of PCE Instruments.
- The instrument should never be placed with the user interface facing an object (e.g. keyboard side on a table).
- You must not make any technical changes to the device.
- The appliance should only be cleaned with a dry cloth. / Do not use any abrasives or solvents.



This manual is published by PCE Instruments without any guarantee.

We expressly point to our general guarantee terms which can be found in our general terms of business.

If you have any questions please contact PCE Instruments.

### 3 Specifications

#### 3.1 General

Display	4- digit LCD, maximum reading 6200
Polarity	negative signal is indicated by  icon
Sampling rate	3 times/s
Power supply	2 x 1.5 V AAA batteries
Battery life	approx. 50 hours (without buzzer and backlight function)
Battery level indication	insufficient battery voltage is indicated by  icon
Auto Power Off	after 30 minutes of inactivity to save battery consumption; function can be disabled by pressing and holding the HOLD key after an Auto Power Off before the meter is turned on again.
Operating conditions	0 ... 40 °C (32 ... 104 °F); <70 % RH
Storage conditions	-10 ... 60 °C (14 ... 140 °F); <80 % RH
Overload indication	when signal exceeds maximum limit, the  icon appears
Maximum clamp opening	diameter 25 mm
Dimensions	210 x 62 x 36 mm
Weight	273 g with battery

### 3.2 Electrical

#### Direct voltage

Range	Resolution	Accuracy
600 V	0.1 V	±1 % + 2 digits

Input impedance: 1 MΩ

#### Direct voltage (peak model)

Range	Resolution	Accuracy
600 V	0.1 V	±1.5 % + 8 digits

Input impedance: 1 MΩ

#### Alternating voltage

Range	Resolution	Accuracy
600 V	0.1 V	±1.2 % ±5 digits (50 ... 500 Hz)

Input impedance: 1 MΩ

#### Alternating voltage (peak model)

Range	Resolution	Accuracy
600 V	0.1 V	±1.7 % + 10 digits

Input impedance: 1 MΩ

#### Direct current

Range	Resolution	Accuracy
60 A	0.01 A	±2 % + 5 digits
600 A	0.1 A	

#### Direct current (peak model)

Range	Resolution	Accuracy
600 A	0.1 A	±2.5 % + 8 digits

#### Alternating current

Range	Resolution	Accuracy
60 A	0.01 A	±2.0 % ± 5 digits (50 ... 60 Hz)
600 A	0.1 A	±3.0 % ± 5 digits (60 ... 500 Hz)

#### Alternating current (peak model)

Range	Resolution	Accuracy
600 A	0.1 A	±2.5 % + 10 digits

#### Resistance (Ω)

Range	Resolution	Accuracy
1000 Ω	0.1 Ω	±1 % + 2 digits









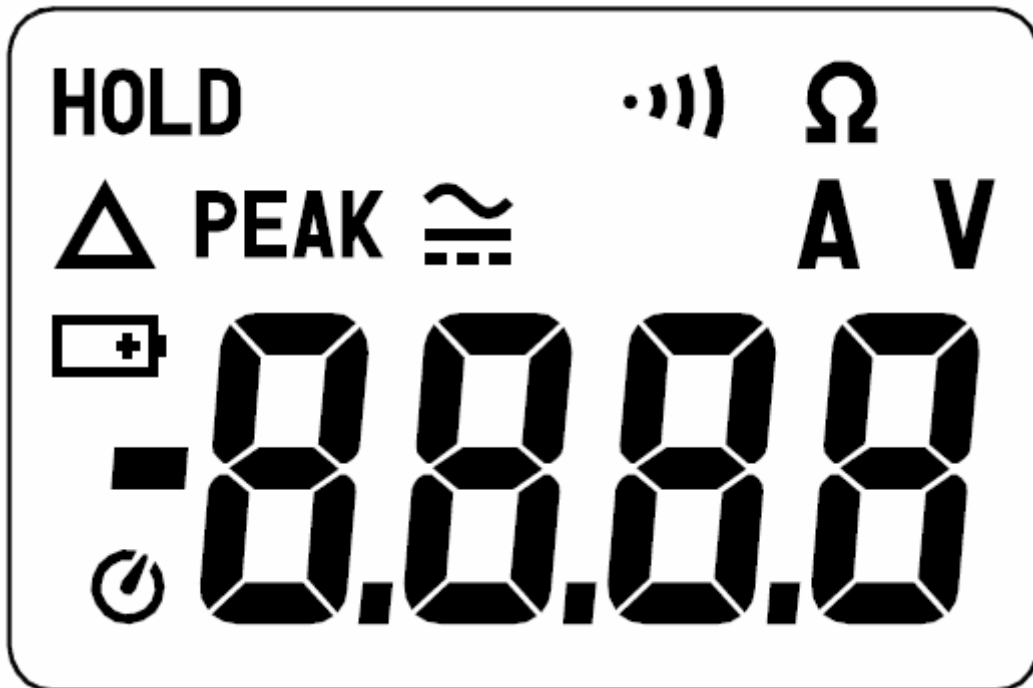

#### Continuity

Range	Buzzer function
	<40 Ω

## 4 System description

### 4.1 Display



	Auto Power Off indication
	Polarity indication
	Battery level indication (low battery)
	Alternating-current source indication
	Direct-current source indication
	Current measurement indication
	Voltage measurement indication
<b>HOLD</b>	Data Hold indication
<b>PEAK</b>	Peak data indication
	Continuity test indication
	Resistance measurement indication
	Zero measurement indication

## 4.2 Front and rear

- 1 Current sensing clamp
- 2 Lever to open clamp
- 3 Dial for function selection
- 4 PEAK key
- 5 Backlight key
- 6 HOLD key
- 7 LC display
- 8 COM input terminal
- 9 Positive input terminal
- 10 Battery compartment

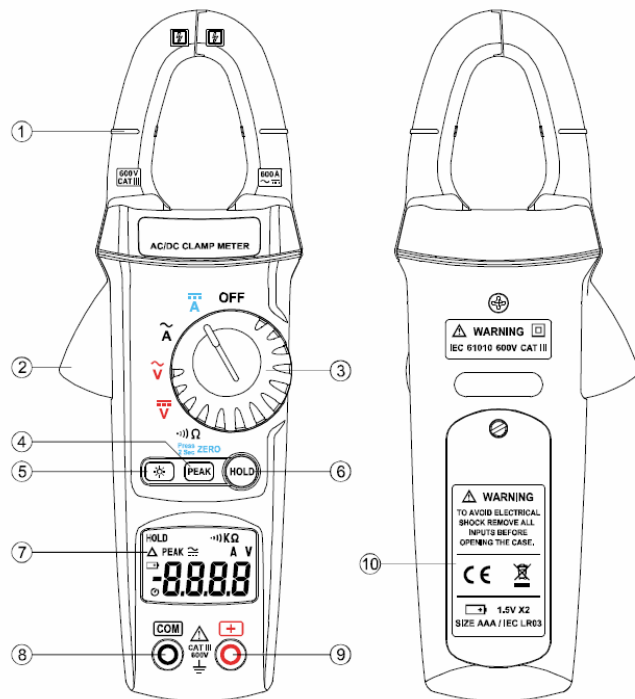

## 4.3 Key functions

### 4.3.1 HOLD function

You can freeze the current value in the display by pressing the HOLD key. To deactivate this function, press the HOLD key once again.



### 4.3.2 PEAK function

When you press the PEAK key, the PEAK icon will appear in the display. The highest value will be displayed and frozen in the display. This value is updated anytime a higher value is measured. To return to normal mode, press the PEAK key again.

### 4.3.3 Zero function

When you press and hold the PEAK key for at least 2 seconds, the  icon will be shown. This means that the zero function is activated, i. e. that the reading is reset to zero. To return to normal mode, press the PEAK key again.

### 4.3.4 Backlight function

You can turn on the backlight function by pressing the  key. The backlight is a yellow light which will shine for 15 seconds when activated. To turn off this function, press the  key again.

## 5 Instructions

### 5.1 Measurement

#### 5.1.1 AC voltage measurement

Switch the main function selector to  $\tilde{V}$ .  
Connect the red test lead to the + terminal and the black test lead to the COM terminal.  
Touch the test circuit with the tips of the test leads and read the result which will appear in the LCD.

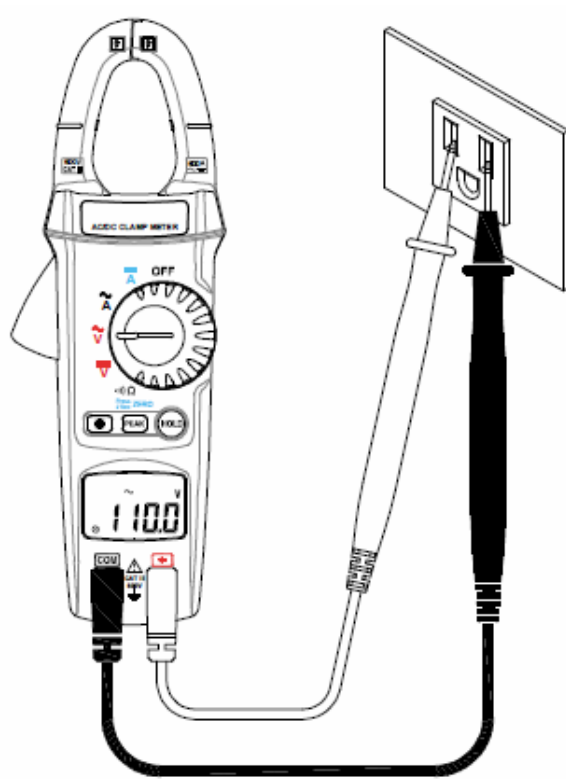

#### 5.1.2 DC voltage measurement

Switch the main function selector to  $\bar{V}$ .  
Connect the red test lead to the + terminal and the black test lead to the COM terminal.  
Touch the test circuit with the tips of the test leads and read the result which will appear in the LCD.

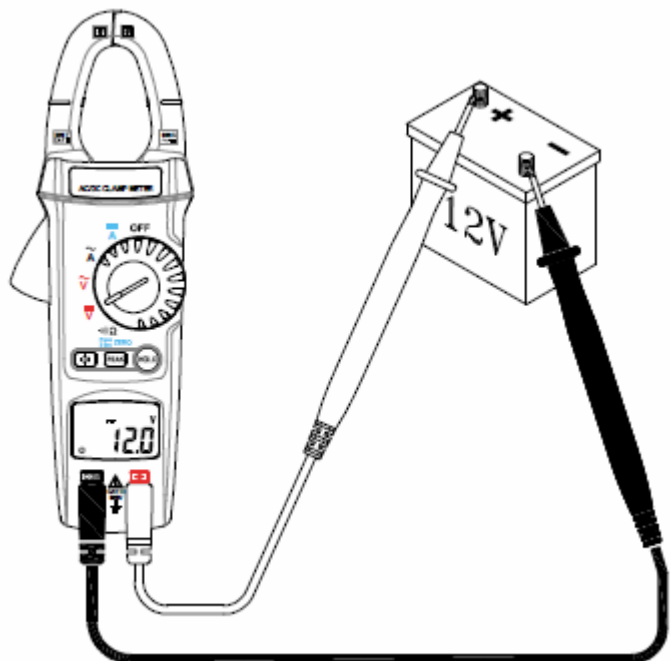



### 5.1.3 AC current measurement

For safety reasons, it is recommended to disconnect the test leads from the meter before carrying out this measurement. Then switch the main function selector to  $\tilde{A}$ . Open the clamp by pushing the lever and insert the cable to be measured into the hole. When the cable is kept at the centre, this will ensure most accurate results. Close the clamp and read the result from the LCD. It might occur that the result is hard to read. In this case, press the HOLD key and read the result at a later stage.

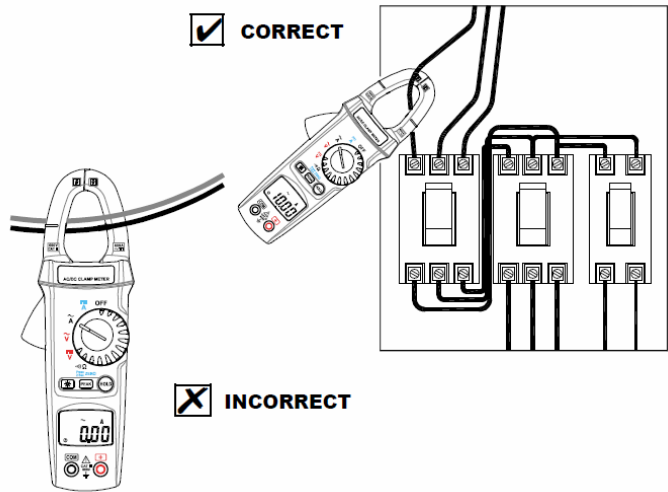

### 5.1.4 DC current measurement

For safety reasons, it is recommended to disconnect the test leads from the meter before carrying out this measurement. Switch the main function selector to  $\overline{A}$ . Open the clamp by pushing the lever and insert the cable to be measured into the hole. When the cable is kept at the centre, this will ensure most accurate results. Close the clamp and read the result from the LCD. It might occur that the result is hard to read. In this case, press the HOLD key and read the result at a later stage.

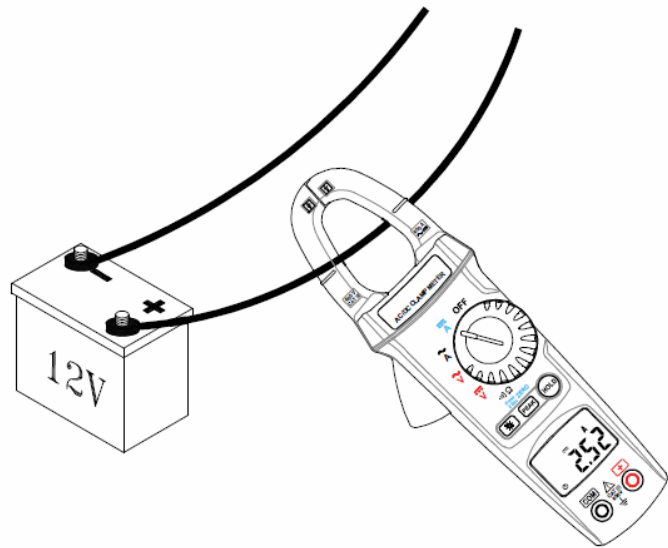

### 5.1.5 Resistance measurement

Before taking a resistance measurement, make sure that the power is cut off from the circuit and that all capacitors are discharged. Then switch the main function selector to  $\Omega$ . Connect the red test lead to the + terminal and the black test lead to the COM terminal. Touch the points to be tested with the tips of the test leads and read the result which will appear in the LCD.

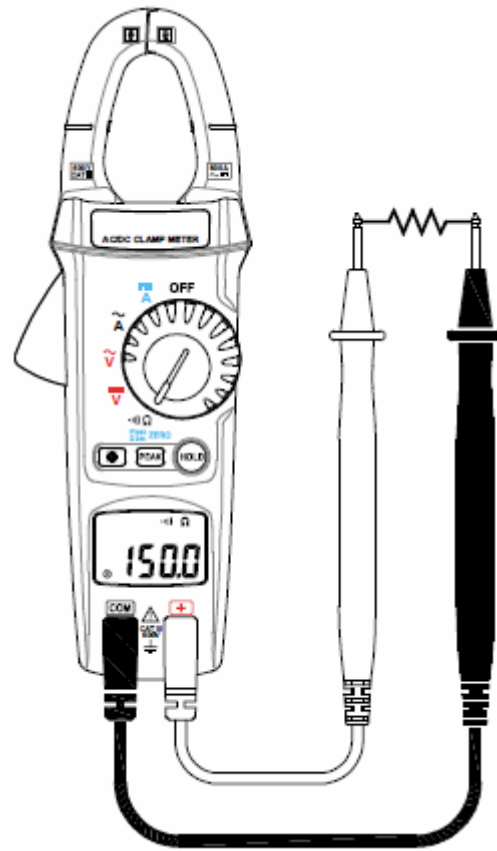

### 5.1.6 Continuity test with buzzer

Switch the main function selector to  $\Omega$  with a buzzer icon. Connect the red test lead to the + terminal and the black test lead to the COM terminal. Place the tips of the test leads at the points where you wish to carry out the continuity test. If the resistance is below  $40 \Omega$ , the beeper will sound continuously.

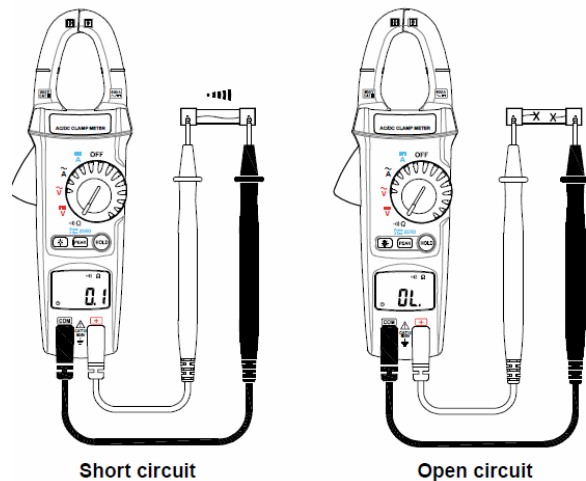

## 5.2 Battery replacement

When the battery voltage drops below a sufficient level, the  icon will appear in the display. When this happens, please replace the battery.

Before doing so, switch the function selector to OFF and disconnect the test leads. Use a screwdriver to open the battery compartment cover. Replace the used batteries with two new 1.5 V AAA batteries. Close the battery compartment cover and fasten the screw.

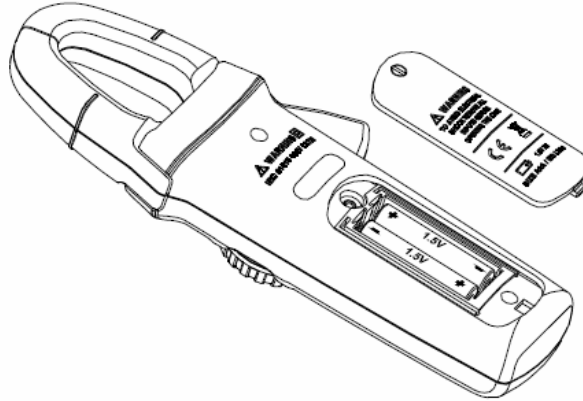

For the disposal of batteries, the 2006/66/EC directive of the European Parliament applies. Due to the contained pollutants, batteries must not be disposed of as household waste. They must be given to collection points designed for that purpose.

In order to comply with the EU directive 2012/19/EU we take our devices back. We either re-use them or give them to a recycling company which disposes of the devices in line with law.

If you have any questions, please contact PCE Instruments.

## 5.3 Maintenance

### Warning!

Before opening the meter, disconnect both test leads and close the cover.

### **Caution!**

To avoid contamination or static damage, do not touch the circuit board without proper static protection.

- When you know that you will not use the device for a longer period of time, take out the batteries and store it in a cool, dry place.
- Repairs or maintenance not described in this manual should only be carried out by qualified personnel.

## 5.4 Cleaning

Wipe the case with a dry cloth on a regular basis. Do not use any abrasives or solvents.

## 6 Contact

If you have any questions about our range of products or measuring instruments please contact PCE Instruments.

### 6.1 PCE Instruments UK

**By post:**

PCE Instruments UK Ltd.  
Units 12/13 Southpoint Business Park  
Ensign Way, Southampton  
Hampshire

United Kingdom, SO31 4RF

**By phone:**

02380 987 035

### 6.2 PCE Americas

**By post:**

PCE Americas Inc.  
711 Commerce Way  
Suite 8  
Jupiter  
33458 FL  
USA

**By phone:**

561 320 9162

