



User Manual

PCE-XXM 30 Colorpicker



User manuals in various languages (français, italiano, español, português, nederlands, türk, polski, русский, 中文) can be found by using our product search on: www.pce-instruments.com

Last change: 25 February 2022
v1.0



Contents

1	Safety notes	1
2	Specifications	2
3	Delivery scope	2
4	Device description	3
5	Switch the meter on and off	3
6	Make a measurement	3
6.1	Pass/Fail measurement.....	4
7	App connection	4
7.1	Establish connection	4
7.2	Operation	5
7.3	Settings.....	6
7.4	Calibration.....	10
7.5	Viewing saved measurement data.....	11
8	Contact	12
9	Disposal	12

1 Safety notes

Please read this manual carefully and completely before you use the device for the first time. The device may only be used by qualified personnel and repaired by PCE Instruments personnel. Damage or injuries caused by non-observance of the manual are excluded from our liability and not covered by our warranty.

- The device must only be used as described in this instruction manual. If used otherwise, this can cause dangerous situations for the user and damage to the meter.
- The instrument may only be used if the environmental conditions (temperature, relative humidity, ...) are within the ranges stated in the technical specifications. Do not expose the device to extreme temperatures, direct sunlight, extreme humidity or moisture.
- Do not expose the device to shocks or strong vibrations.
- The case should only be opened by qualified PCE Instruments personnel.
- Never use the instrument when your hands are wet.
- You must not make any technical changes to the device.
- The appliance should only be cleaned with a damp cloth. Use only pH-neutral cleaner, no abrasives or solvents.
- The device must only be used with accessories from PCE Instruments or equivalent.
- Before each use, inspect the case for visible damage. If any damage is visible, do not use the device.
- Do not use the instrument in explosive atmospheres.
- The measurement range as stated in the specifications must not be exceeded under any circumstances.
- Non-observance of the safety notes can cause damage to the device and injuries to the user.

We do not assume liability for printing errors or any other mistakes in this manual.

We expressly point to our general guarantee terms which can be found in our general terms of business.

If you have any questions please contact PCE Instruments. The contact details can be found at the end of this manual.



2 Specifications

Measuring geometry and angle	D/8-SCI
Calibration	Automatic
Colour spaces	CIE-LAB, CIE-LCh, HunterLab, CIE-Luv, Yxy, XYZ, RGB
Formulas for colour difference	ΔE^*ab , ΔE^*cmc , ΔE^*94 , ΔE^*00
WI	ASTM E313-00, ASTM E313-73, CIE/ISO, AATCC, Hunter, Taube Berger Stensby
YI	ASTM D1925, ASTM E313-00, ASTM E313-73
Blackness	M _y , dM
Colour shade	ASTM E313-00
Colour density	CMYK(A, T, E, M), Milm, Munsell, opacity, dye strength, colour strength
Light source type	LED (full and visible wavelength range)
Light source	A, B, C D50, D55, D65, D75, F1 ... F12, CWF, U30, DLF, NBF, TL83, TL 84, U35
Measuring angle	2°, 10°
Repeatability	$\Delta E^*ab < 0.1$
Difference with two different colour meters (IIA)	$\Delta E^*00 < 0.4$
Accuracy refers to the average measurement of 12 BCRA Series II references.	
Measuring aperture	Ø8 mm
Wavelength interval	10 mm
Wavelength	400 ... 700 nm
Measuring time	<1 s
Display	LC display, 135 x 240 p, 1.14"
Interfaces	Bluetooth, USB-C
Power supply	5 V DC, 1 A
Battery life	approx. 10,000 measurements
Environmental conditions	5 ... 45 °C, <90 RH, non-condensing
Dimensions	Ø35 x 130 mm / Ø1.37 x 5.11"
Weight	87 g / 3 oz

3 Delivery scope

- 1 x PCE-XXM 30
- 1 x white reference
- 1 x USB-C cable
- 1 x user manual

4 Device description

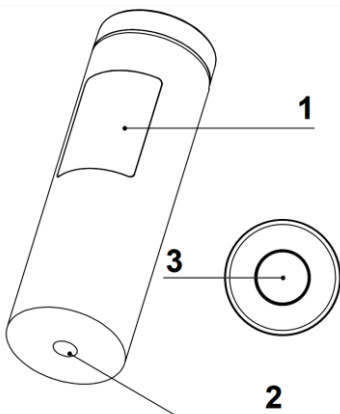

No.	Description
1	Display
2	Measuring aperture
3	Magnetic white reference, serial number, model name and key

5 Switch the meter on and off

To switch on the meter, press the key on the top of the meter. To turn off the meter, press and hold this key until "Power off" is displayed. This takes at least 5 seconds.

6 Make a measurement

To make a measurement, first switch on the meter. Remove the white reference and then place it on the key of the meter so that the serial number and model name are on the outside and the white reference is no longer visible on the inside. A magnet in the reference will keep the module in place. Now place the meter appropriately on your sample. Make sure that the measuring aperture is completely closed. Now push the magnetic reference plate to press the measuring key. The measurement is carried out directly and the measured value is shown on the display.

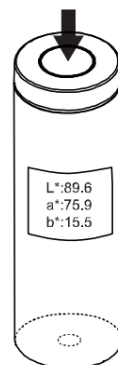

Note:

To be able to make settings to the meter, an Android-capable end device with a Bluetooth interface is required.



6.1 Pass/Fail measurement

With the Pass/Fail function, colours can be compared to each other. To access this function, press and hold the key on the meter for two seconds. The meter switches directly to this mode. The measurement can be made directly. If the measured value is within the set parameters, "PASS" is displayed and the display appears in green. If the measured values are outside the parameters, "FAIL" is displayed and the display turns red. To return to normal measuring mode, press and hold this key again for two seconds.

Note:

To be able to make settings to the meter, an Android-capable end device with a Bluetooth interface is required.

7 App connection

In order to connect the meter to an Android-enabled meter, the meter must have a Bluetooth interface. To make settings, the PCE-XXM 30 app must be downloaded. This app can be found in the Play Store.



7.1 Establish connection

After installing the app, it can be opened directly. A connection to the meter can then be established via the "Connect" button. If necessary, you will be asked for a recommended calibration after the connection has been established.

Note:

The connection must not be made via the Bluetooth setting of the mobile end device. The connection must be established via the app.

7.2 Operation

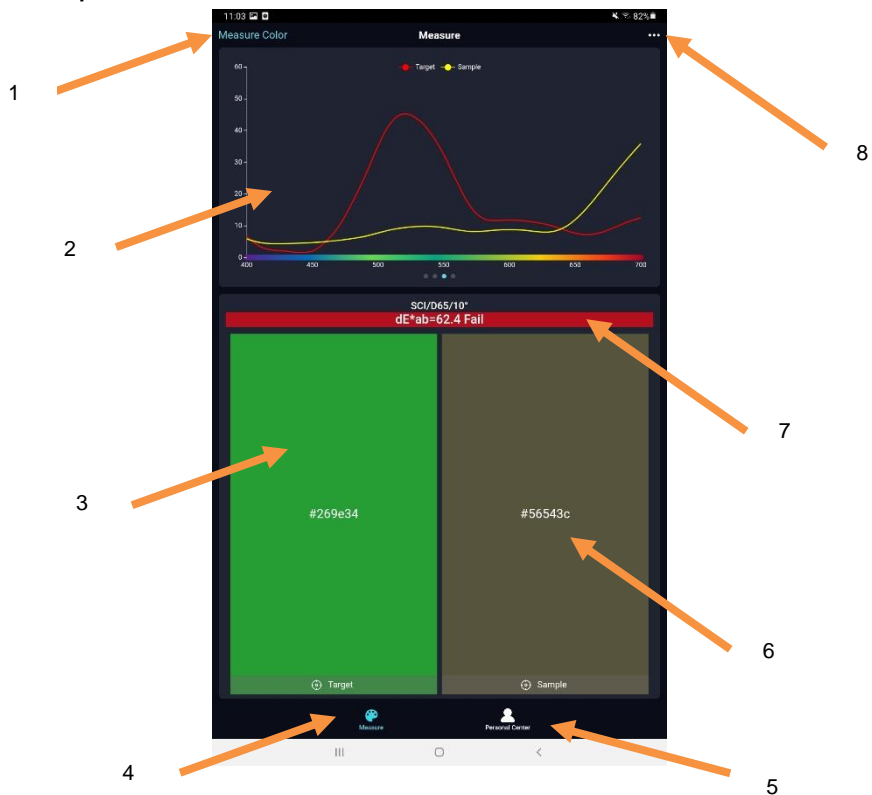

No.	Description
1	Start measurement
2	Measured value display Other views are available by swiping left or right.
3	Measurement of the reference colour
4	View of the measurement window
5	View of all settings
6	Measurement of the sample colour
7	Indication whether the sample colour is within the set parameters of the reference colour
8	Settings of the meter's parameters and view of all measured colours

7.3 Settings

To make settings, go to "Personal Center". From there you can make the following settings:

Setting	Meaning
Connecting, Disconnect	Connect and disconnect the meter.
Device Data	Read out the data memory and clear it if necessary. The values can only be saved on the mobile end device.
Settings	Measurement parameters can be set here.
Language	The language of the meter and the app can be set here. If the language has been set, a synchronisation must be carried out via "Settings" so that the language is adopted. If a language is not available in the meter, English is used.
About	General information about the app is displayed here.



Note:

Once settings have been made, they must be synchronised with the meter. You can do this by applying the "Sync to instrument" button.

In the "Parameters" window, settings for the measurement can be made, such as the colour spaces or the light source.

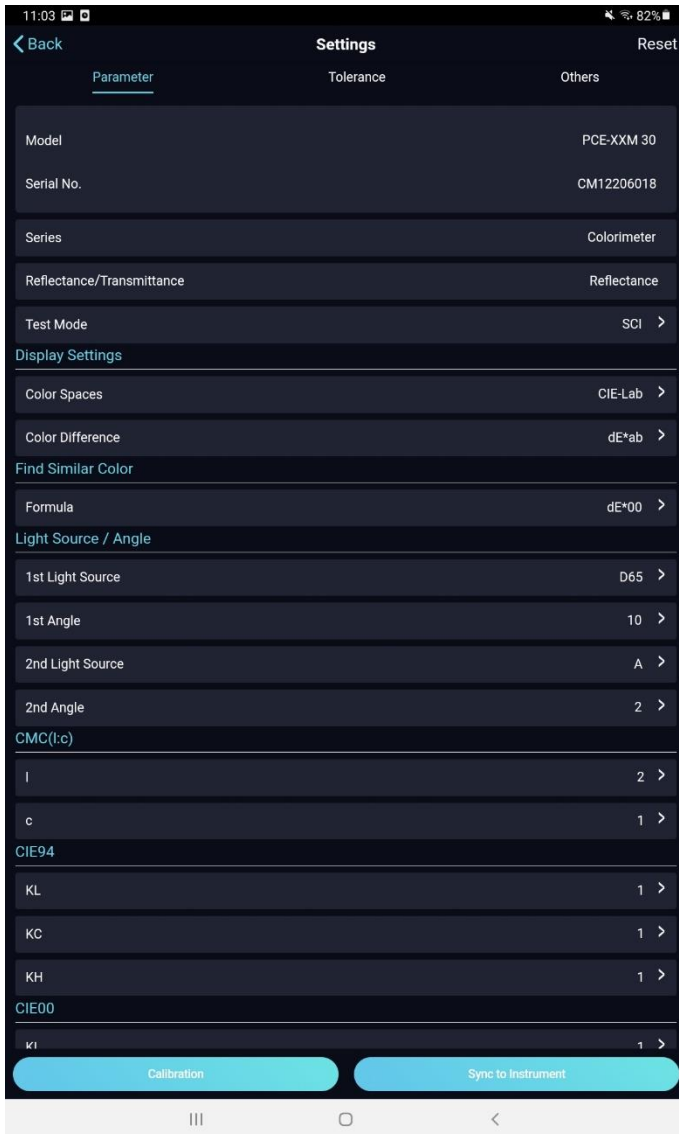



Via the item "Tolerance", all settings for the pass/fail function can be made.

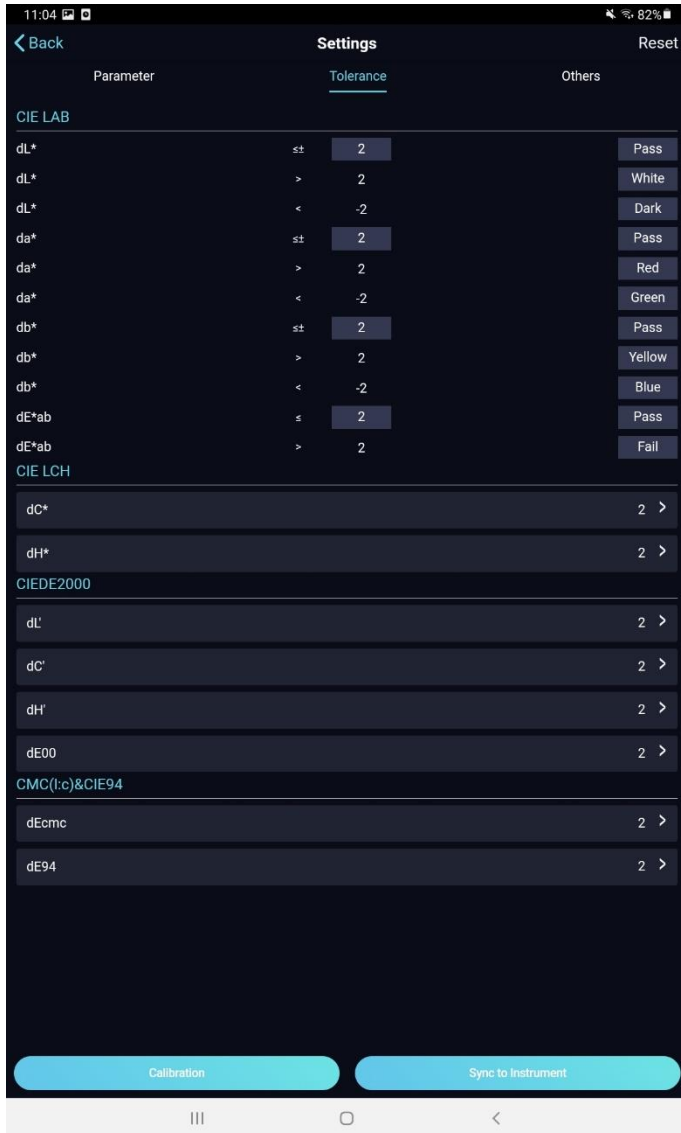

Under "Others", further settings can be made, such as naming the measurements and determining whether a measurement should be a single measurement or an average measurement.

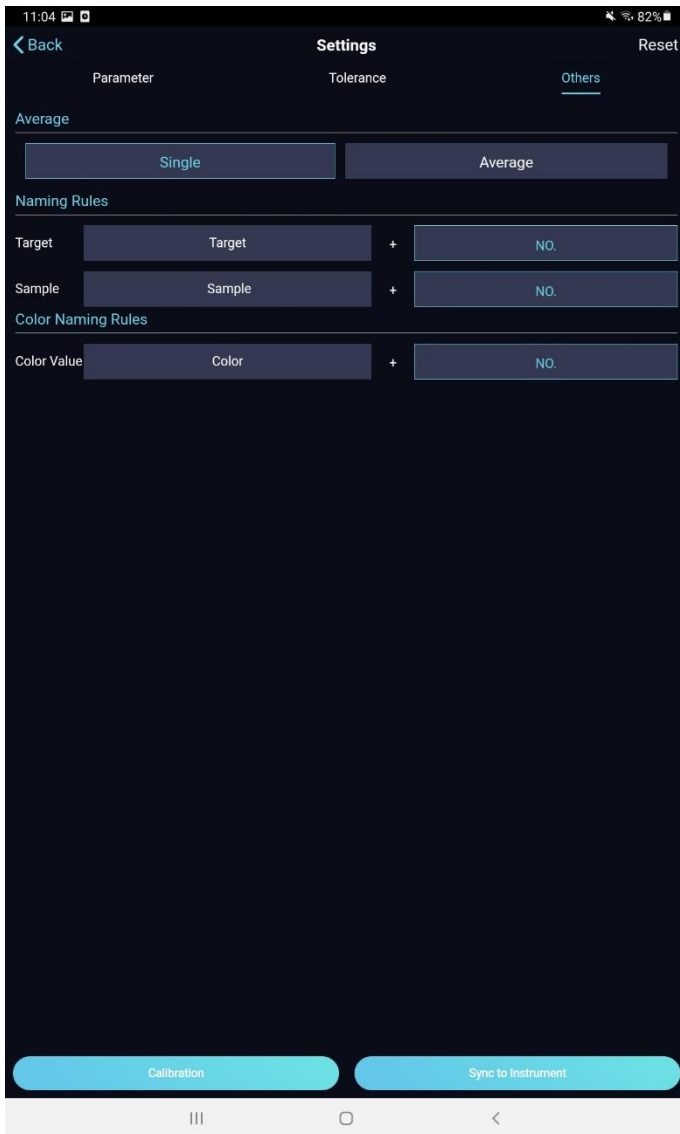

7.4 Calibration

To perform a calibration, press "Calibration" in the menu item "Settings". Here, a white calibration is made first. Position the white reference according to the display in the app. Then press "Calibration". The white calibration can also be skipped with "Skip" if necessary. The black calibration is then carried out. To do this, hold the measuring device at least one metre in the air and then press "Calibration". If necessary, this can also be skipped via "Skip". The calibration is now complete.

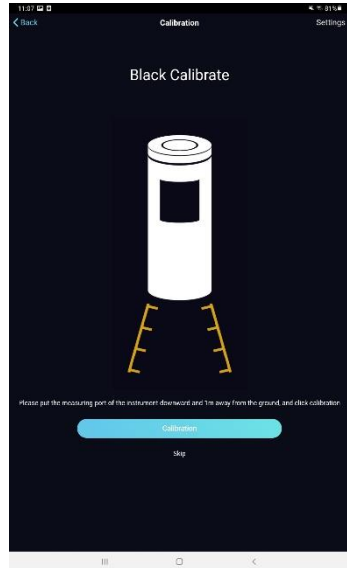
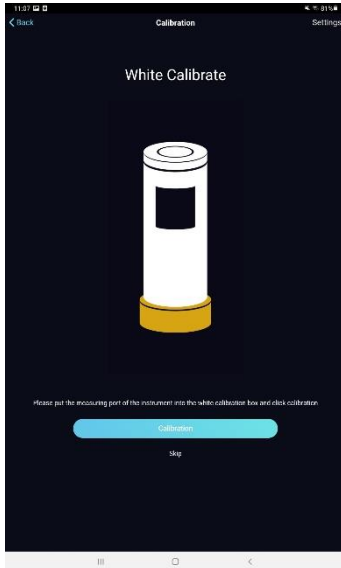

7.5 Viewing saved measurement data

Under "Measure History", the measured colours can be read out. If necessary, these can also be deleted.

Note:

It is not possible to export the data.

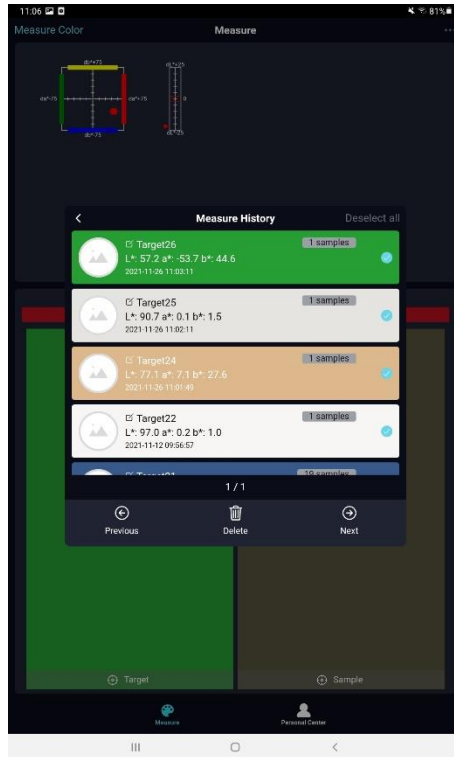



8 Contact

If you have any questions, suggestions or technical problems, please do not hesitate to contact us. You will find the relevant contact information at the end of this user manual.

9 Disposal

For the disposal of batteries in the EU, the 2006/66/EC directive of the European Parliament applies. Due to the contained pollutants, batteries must not be disposed of as household waste. They must be given to collection points designed for that purpose.

In order to comply with the EU directive 2012/19/EU we take our devices back. We either re-use them or give them to a recycling company which disposes of the devices in line with law.

For countries outside the EU, batteries and devices should be disposed of in accordance with your local waste regulations.

If you have any questions, please contact PCE Instruments.



PCE Instruments contact information

Germany

PCE Deutschland GmbH
Im Langel 26
D-59872 Meschede
Deutschland
Tel.: +49 (0) 2903 976 99 0
Fax: +49 (0) 2903 976 99 29
info@pce-instruments.com
www.pce-instruments.com/deutsch

United Kingdom

PCE Instruments UK Ltd
Unit 11 Southpoint Business Park
Ensign Way, Southampton
Hampshire
United Kingdom, SO31 4RF
Tel: +44 (0) 2380 98703 0
Fax: +44 (0) 2380 98703 9
info@pce-instruments.co.uk
www.pce-instruments.com/english

The Netherlands

PCE Brookhuis B.V.
Institutenweg 15
7521 PH Enschede
Nederland
Telefoon: +31 (0)53 737 01 92
info@pcebenelux.nl
www.pce-instruments.com/dutch

France

PCE Instruments France EURL
23, rue de Strasbourg
67250 Soultz-Sous-Forets
France
Téléphone: +33 (0) 972 3537 17
Numéro de fax: +33 (0) 972 3537 18
info@pce-france.fr
www.pce-instruments.com/french

Italy

PCE Italia s.r.l.
Via Pesciatina 878 / B-Interno 6
55010 Loc. Gragnano
Capannori (Lucca)
Italia
Telefono: +39 0583 975 114
Fax: +39 0583 974 824
info@pce-italia.it
www.pce-instruments.com/italiano

United States of America

PCE Americas Inc.
1201 Jupiter Park Drive, Suite 8
Jupiter / Palm Beach
33458 FL
USA
Tel: +1 (561) 320-9162
Fax: +1 (561) 320-9176
info@pce-americas.com
www.pce-instruments.com/us

Spain

PCE Ibérica S.L.
Calle Mayor, 53
02500 Tobarra (Albacete)
España
Tel. : +34 967 543 548
Fax: +34 967 543 542
info@pce-iberica.es
www.pce-instruments.com/espanol

Turkey

PCE Teknik Cihazları Ltd.Şti.
Halkalı Merkez Mah.
Pehlivan Sok. No.6/C
34303 Küçükçekmece - İstanbul
Türkiye
Tel: 0212 471 11 47
Faks: 0212 705 53 93
info@pce- cihazlari.com.tr
www.pce-instruments.com/turkish