

Manual Humidity Detector PCE-555



Contents

| | | |
|----------|---|----------|
| 1 | Introduction | 2 |
| 2 | Safety notes | 3 |
| 3 | Specifications | 4 |
| 4 | System description | 5 |
| 5 | Instructions..... | 6 |
| 5.1 | To switch on the device | 6 |
| 5.2 | To select the temperature to be measured and the unit | 6 |
| 5.3 | Humidity and ambient temperature measurement | 6 |
| 5.4 | MAX / MIN function..... | 6 |
| 5.5 | To freeze / hold the reading..... | 6 |
| 5.6 | To switch the backlight on and off | 6 |
| 5.7 | Automatic Power Off..... | 6 |
| 5.8 | To replace the battery..... | 6 |
| 6 | Disposal | 7 |
| 7 | Contact..... | 7 |
| 7.1 | PCE Instruments UK | 7 |
| 7.2 | PCE Americas | 7 |

1 Introduction

Thank you for purchasing a hygrometer PCE-555 from PCE Instruments.

This digital humidity and temperature meter which can also measure the wet bulb temperature and the dew point temperature is commonly used in laboratories, in the construction industry, in building technology, in different industrial sectors and in engineering. It is also very useful in the areas of transportation and storage of food as it supports the prevention of mould. Since this hygrometer is quick and compact, it can easily be used on-site.

2 Safety notes

Please read this manual carefully and completely before you use the device for the first time. The device may only be used by qualified personnel and repaired by PCE Instruments personnel. There is no warranty of damages or injuries caused by non-observance of the manual.



- This meter may only be used as described in the manual. Otherwise, hazardous situations may occur.
- The device may only be used within the temperature and atmospheric humidity ranges laid down in the specifications. Do not expose it to extreme temperatures, direct sunlight, extreme atmospheric humidity or moisture.
- Never use the device when your hands are wet.
- Do not touch the sensor.
- The case should only be opened by qualified personnel of PCE Instruments.
- The instrument should never be placed with the user interface facing an object (e.g. keyboard side on a table).
- You should not make any technical changes to the device.
- The appliance should only be cleaned with a damp cloth / use only pH-neutral cleaner, no abrasives or solvents.
- Only use PCE accessories or equivalent along with the device.
- Check the case for visible damage before each use. If damage is visible, do not use the device.
- The meter must not be used in explosive atmospheres.
- The limit values for the measurements stipulated in the specifications must under no circumstances be exceeded.
- In case of non-observance of these safety notes, damage to the device as well as injury of the user are possible.

This manual is published by PCE Instruments without any guarantee.

We expressly point to our general guarantee terms which can be found in our general terms of business.



If you have any questions please contact PCE Instruments.

3 Specifications

| | |
|---|--|
| Measurement range humidity | 0 % .. 100 % RH |
| Measurement range temperature | -30 °C ... 100 °C / -30 °F ... 199 °F |
| Measurement range dew point temperature | -30 °C ... 100 °C / -22 °F ... 199 °F |
| Measurement range wet bulb temperature | 0 °C ... 80 °C / 32 °F ... 176 °F |
| Accuracy | ± 2 % RH at 25 °C and 20 ... 80 % RH, otherwise ± 2.5 % ± 0.5 °C / ± 0.9 °F (at 25 °C), otherwise ± 0.8 °C / ± 1.5 °F |
| Resolution | 0.01 % RH, 0.01 °C / 0.01 °F |
| Response time % RH | approx. 10 sec (90 % at ambient temperature of 25 °C / 77 °F) |
| Hold function | Max Hold and Data Hold function |
| Display | 4.5 digit dual LC display with backlight |
| Energy efficiency | Automatic Power Off after 15 minutes of inactivity, can be deactivated (when the device is switched off, first press and hold the Hold key and then press the On/Off key at the same time. When the display comes on, release both keys. The  icon will not be displayed anymore and the device will not be powered off automatically anymore.. |
| Sensor | One-chip multisensor module for relative humidity with calibrated digital output |
| Sampling rate | 2.5 times per second |
| Polarity | automatic, negative polarity indication |
| Overload | "OL" icon is displayed |
| Power supply | 1 x standard 9 V battery, NEDA1604 or 6F22 |
| Battery indication |  is displayed when the battery voltage falls below the necessary level |
| Operating conditions | 0 ... 40 °C (32 ... 104 °F), < 80 % RH, non-condensing |
| Storage conditions | -10 ... 60 °C (14 ... 140 °F), < 80 % RH, non-condensing |
| Dimensions | 225 (H) x 45 (W) x 34 mm (D) / ≈8.86 (H) x 1.77 (W) x 1.34" (D) |
| Weight | 200 g (≈0.44 lb) |

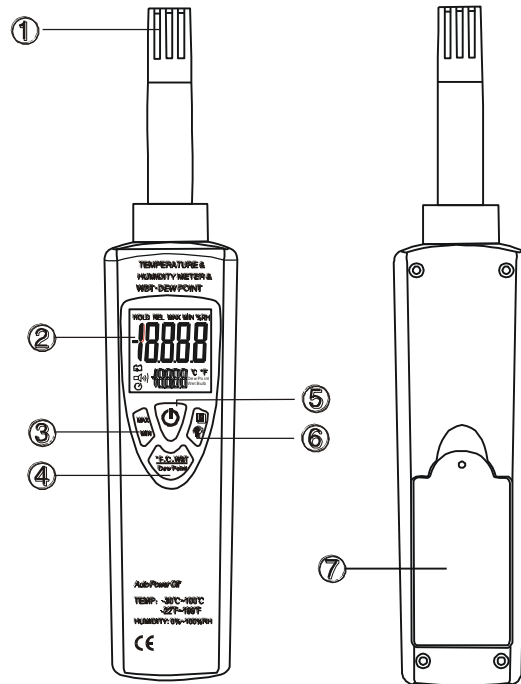
4 System description



- 1) **Humidity / ambient temperature probe:** semi conductor sensor for humidity and temperature inside.
- 2) **LC display:** 4.5-digit dual LC display showing the units °C and °F as well as the relative humidity percentage, the dew point temperature, the wet bulb temperature, low battery indication and “MIN / MAX HOLD”.
- 3) **MAX / MIN key**
- 4) **°F / °C / WBT / Dew Point selection key:** key to select temperature, dew point temperature or wet bulb temperature, either in °F or °C.
- 5) **On/Off key:** to switch the device on and off.
- 6) **HOLD /  key:** Press this key to activate the HOLD function. The reading will then be held.
To switch the backlight on or off, press and hold the HOLD /  key for more than 2 seconds.
- 7) **Battery compartment**

5 Instructions

5.1 To switch on the device

Switch the device on by means of the On/Off key (5).

5.2 To select the temperature to be measured and the unit

Press the °F / °C / WBT / Dew Point selection key (4) to select between temperature, dew point temperature or wet bulb temperature and to choose a unit. Press and hold the key until the desired temperature to be measured appears along with the correct unit. The possible selections appear in the following order: °C → °F → °C Dewpoint → °F Dewpoint → °C Wet Bulb → °F Wet Bulb.

5.3 Humidity and ambient temperature measurement

1. Target the probe (1) at the area which you would like to measure and wait until the values have stabilised.
2. Read the relative humidity, the values for the ambient temperature, the dew point temperature and the wet bulb temperature which are indicated in the display (2).

Note: Do not immerse the probe in liquids as it is only suitable for air.

5.4 MAX / MIN function

1. Select the desired temperature to be measured and unit before activating the MAX / MIN function.
2. Press the MAX / MIN key to enter the MAX / MIN recording mode.
3. If you press the key once, MAX is selected and if you press it twice, MIN is selected. The device will save the highest or the lowest value measured during the time between activation and deactivation of the MAX / MIN function.
4. Press and hold the key for more than 2 seconds to finish the MAX / MIN recording.

5.5 To freeze / hold the reading

Press the HOLD /  key (6) to hold the reading in the display. If you press this key again, you will return to normal measurement mode.



5.6 To switch the backlight on and off

Press and hold the HOLD /  key (6) for more than 2 seconds to switch the backlight on or off.

5.7 Automatic Power Off

To save battery voltage, the device is equipped with an Automatic Power Off function. The device switches off automatically after 15 minutes of inactivity. The  icon indicates that the Automatic Power Off function is activated.

To deactivate the Automatic Power Off function

1. Switch off the device.
2. Press and hold the HOLD /  key (6) and switch on the device by pressing the On/Off key (4) once.
3. After all icons have been shown in the display, release the HOLD /  key (6). The  icon will disappear from the display. Automatic Power Off is now deactivated. When you switch on the device next time, it will be activated again.

5.8 To replace the battery

When the  icon appears in the display, the battery must be replaced. Open the battery compartment and replace the old battery by a new one (1 x 9 V battery NEDA1604, 6F22 or similar).

6 Disposal

For the disposal of batteries, the 2006/66/EC directive of the European Parliament applies. Due to the contained pollutants, batteries must not be disposed of as household waste. They must be given to collection points designed for that purpose.

In order to comply with the EU directive 2012/19/EU we take our devices back. We either re-use them or give them to a recycling company which disposes of the devices in line with law.

If you have any questions, please contact PCE Instruments.



7 Contact

If you have any questions about our range of products or measuring instruments please contact PCE Instruments.

7.1 PCE Instruments UK

By post:

PCE Instruments UK Ltd.
Units 12/13 Southpoint Business Park
Ensign Way, Southampton
Hampshire

United Kingdom, SO31 4RF

By phone:

02380 987 035

7.2 PCE Americas

By post:

PCE Americas Inc.
711 Commerce Way
Suite 8
Jupiter
33458 FL
USA

By phone:

561 320 9162