

WEIGHING CONTROLLER

PCE Americas Inc.
711 Commerce Way
Suite 8
Jupiter
FL-33458
USA
From outside US: +1
Tel: (561) 320-9162
Fax: (561) 320-9176
iinfo@pce-americas.com



PCE Instruments UK Ltd.
Unit 11
Southpoint Business Park
Ensign way
Hampshire / Southampton
United Kingdom, SO31 4RF
From outside UK: +44
Tel: (0) 2380 98703 0 Fax: (0)
2380 98703 9
info@pce-instruments.co.uk

www.pce-instruments.com/english
www.pce-instruments.com

Model: PCE-N45F

Weight Indicator



Please read this manual carefully before operation

USER'S MANUAL

CONTENTS

1. Main specifications	2
2. Dimensions	3
3. Front Overlay and Keypad	4
4. Rear Back Interface	5
5. Load Cell Interface	6
6. Serial Interface	7
7. I/O	7
8. Analog Quantity Output	9
9. Parameter Set	10
9.1 Enter setting menu	10
9.2 Quit Setting	10
9.3 Main Set Menu	10
9.4 System Parameter Set	10
9.4.1 Scale Set	11
9.4.2 Operation Set	14
9.4.3 Batching Set	17
9.4.4 Communication protocol	23
9.4.5 Analog quantity output	25
9.4.6 Diagnosis and maintenance	26
9.5 Recipes Parameters set	31
9.6 Printing table format	35
9.7 System set	35
10. Appendix: Communication Protocol	36
10.1 Continuous transmitting format A	36
10.1 Command transmitting Format A	36
10.2 Command transmitting format A	37
10.3 Continuous transmit format B	37
10.4 Command output format B	37
10.5 MODBUS output format	38
10.6 Multi materials jointed work with relay connected	41

1. Main specifications

Specifications	
Housing	Metal shielded housing, with OLED display
dimensions (w × h × d)	110mm×62mm×116mm
Protection	IP65 (front panel)
Operation Condition	Temperature: -10°C~40°C (14°~104° F) Relative humidity: 10%~95%, non-condensing
Power	+24VDC (±15%) , Consumption <6W
Display	128×64 dot matrix、Yellow-Green OLED
Display resolution	Max.100,000
Platform	1 with analog load cell
Load cells	1~6 x 350 Ohm (Sensitivity is 2 or 3mV/V)
A/D Speed	200Hz (200times/s)
Excitation Voltage	5VDC
Min.Input sensitivity	0.6μV/d
Keypads	4 function keys
Basic	Serial Output: RS232 or RS485 I/O interface: 1xIn 4xOut
Optional	I/O interface: 4xIn 8xOut Analog signal 0~20mA、4~20mA、0~24mA 0~10V、0~5V、-5~+5V、-10~+10V

2. Dimensions

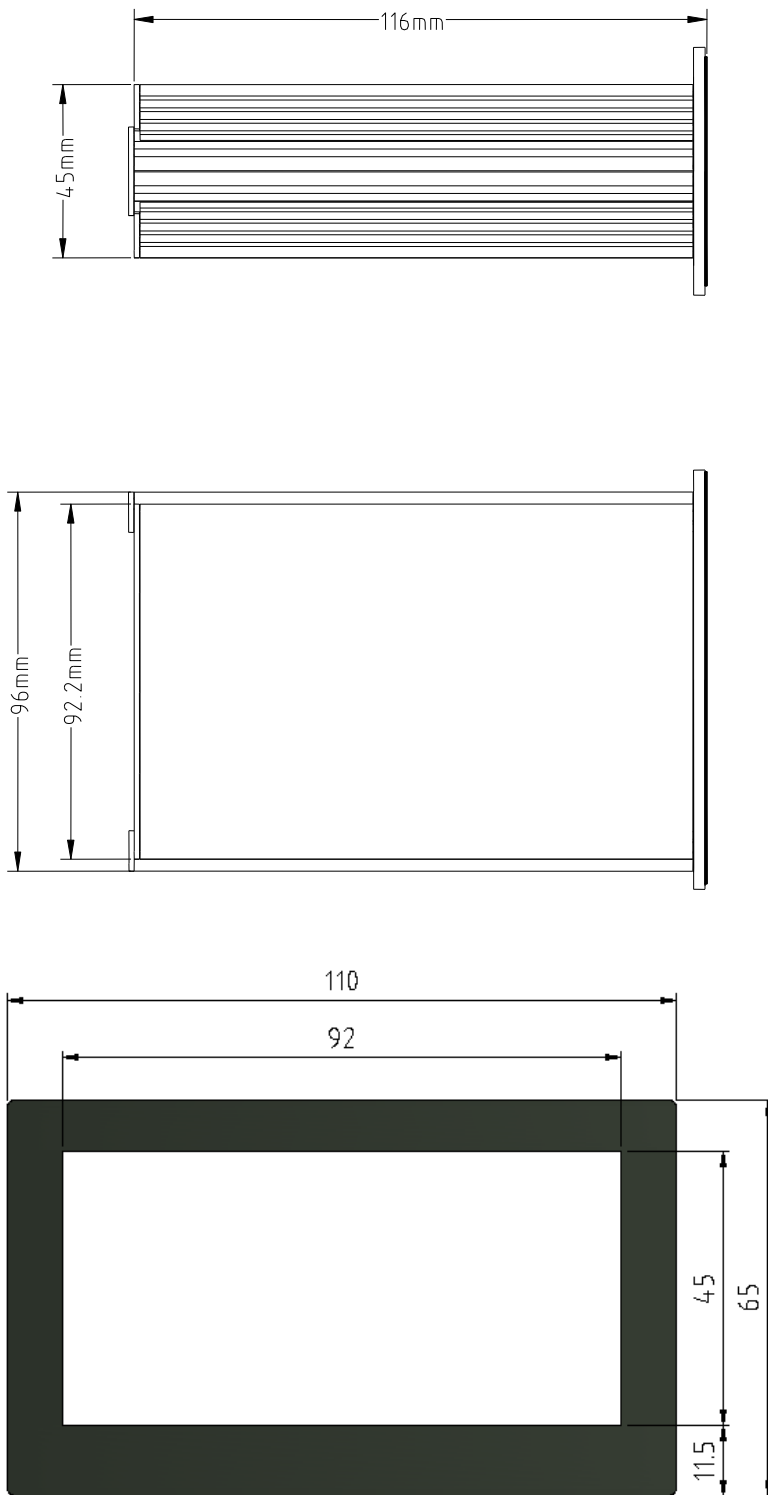

Installation hole size 92×45mm

3. Front Overlay and Keypad

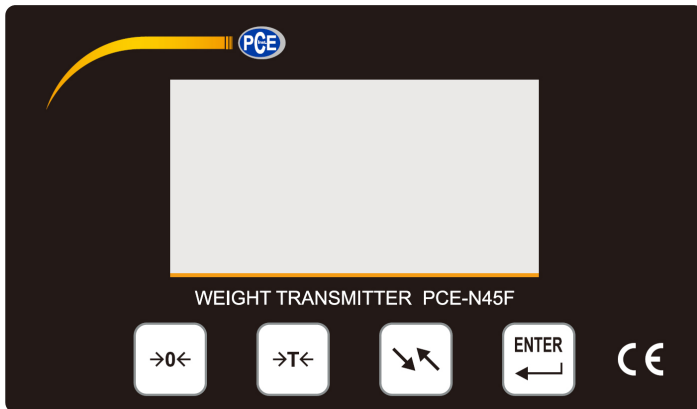



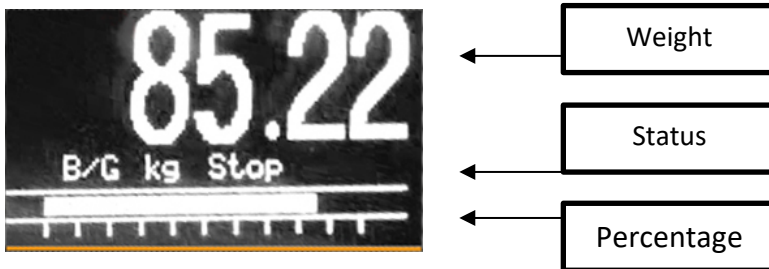

Display



Signs

Status	Note
~	Stable, on for dynamic mode, off for static mode
B/G	Gross weight
Net	Net weight
Kg	Unit
Stop	Stop
Run	Run
M1~M4	Material 1-4
>>	Fast filling
>	Fine filling

Keys' functions for parameter set or choose

Keys	Menu	Parameter set	Parameter Input
	Return	Return	Cancel and Quit
	Up	Previous	Increase digits
	Down	Next	Move right
	Enter	Quit confirm	Quit confirm

4. Rear Back Interface

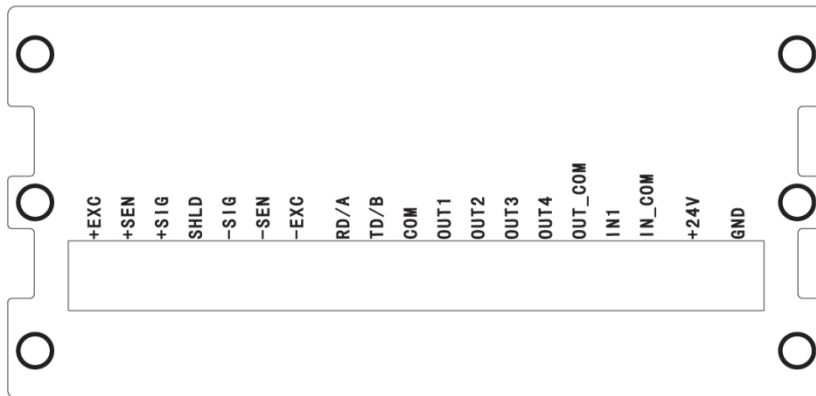

PCE-N45F

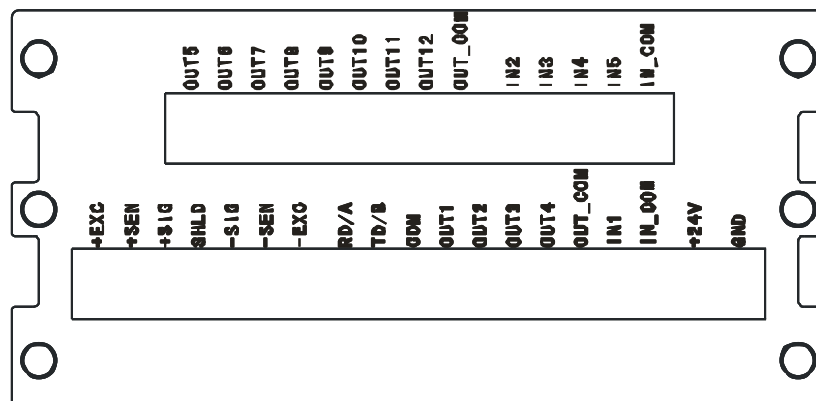

PCE-N45F-IO

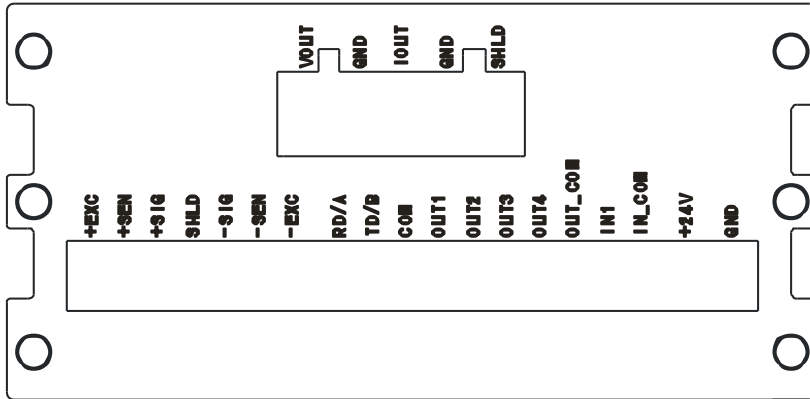

PCE-N45F-DA

5. Load Cell Interface

It can be connected with 6x350Ω analog load cells (around 58Ω minimum resistance), to confirm the range of the load cells, the total resistance (TSR) can be calculated with the formula as below:

$$TSR = \frac{\text{Input resistance } (\Omega)}{\text{Load cell numbers}}$$

Before connecting the load cells, make sure the TSR is above 58Ω, if it's less, the indicator can't work. Besides this, the cable distance must be considered, too, below is the maximum distance suggested:

TSR (Ω)	24# cable (m)	20# cable (m)	16# cable (m)
350	243	610	1219
58 (6-350 Ω)	40	122	224

Load cell interface definitions:

Pins	Signal	Note
+EXC	+Excitation	4-wire load cells short connected
+SEN	+Sense	
+SIG	+Signal	
SHD	Shield	
-SIG	-Signal	
-SEN	-Sense	4-wire load cells short connected
-EXC	-Excitation	

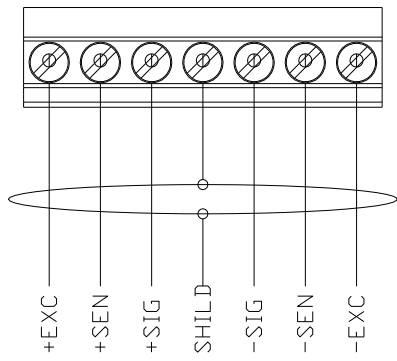

6-wire load cell or junction box

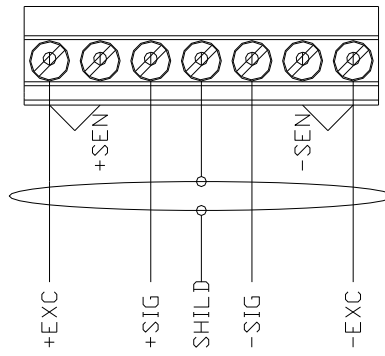

4-wire load cell or junction box

6. Serial Interface

It has only one serial interface, to change it by switch for RS232 or RS485, method as below:

Pins	RS-232	RS-485
Bridge Joint Pin signs	Rear Front	Rear Front
RD/A	RS-232 Receive	RS-485A
TD/B	RS-232 Transmit	RS-485B
COM	Ground	Blank

7. I/O

The basic type has one passive input and 4 relay open output

Basic type Pin's definitions:

Pins	Signal	Note
OUT1	Output 1	Output properties: AC: 30~250VAC/1A DC: 5~30VDC/2A
OUT2	Output 2	
OUT3	Output 3	
OUT4	Output 4	
OUT_COM	Output common port	
IN1	Input 1	High level: 10~24VDC
IN_COM	Input common port	Low level: 0~3VDC

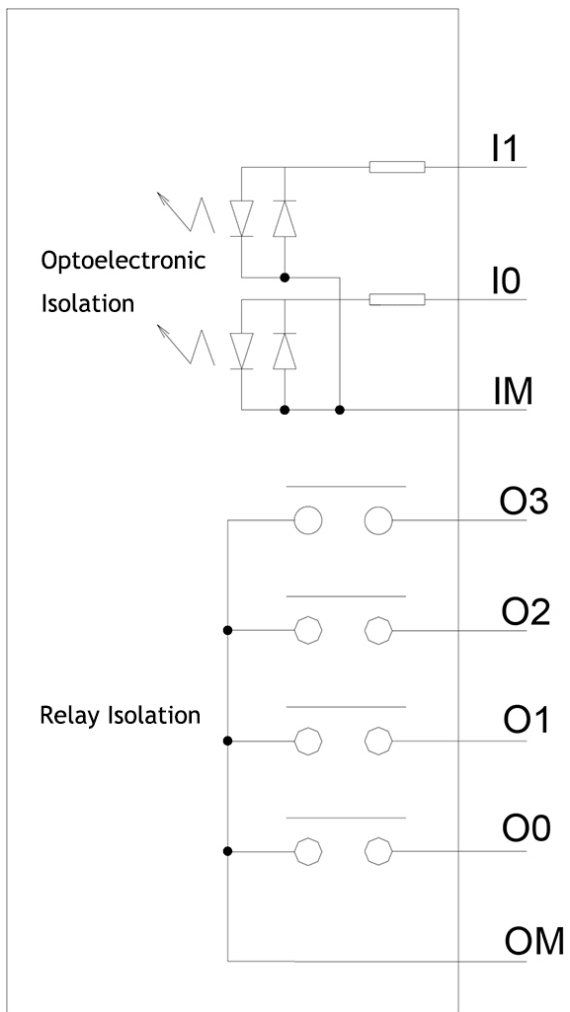

I/O interface drawing

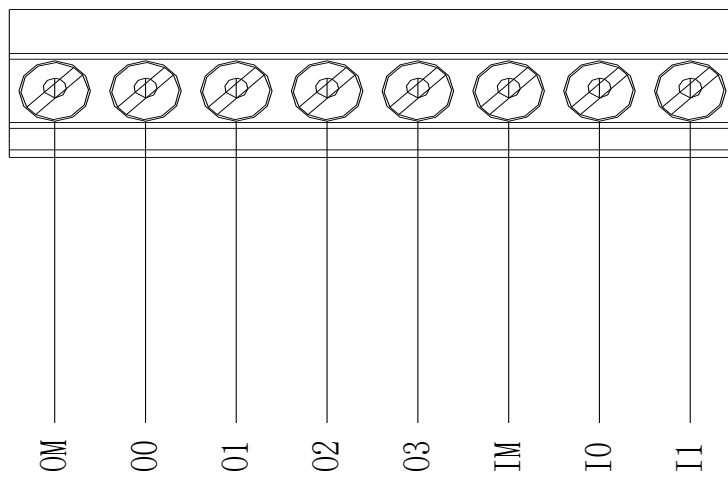

Output - OM/O0/O1/O2/O3

Input - IM/IO/I1

PCE-N45F-IO has 4 passive input and 8 relay open output

Pins definitions:

Pin	Signal	Description
OUT5	Output 5	Output properties: AC: 30~250VAC/1A DC: 5~30VDC/2A
OUT6	Output 6	
OUT7	Output 7	
OUT8	Output 8	
OUT9	Output 9	
OUT10	Output 10	
OUT11	Output 11	
OUT12	Output 12	
OUT_COM	Output common port	
IN2	Input 2	High level: 10~24VDC Low level: 0~3VDC
IN3	Input 3	
IN3	Input 3	
IN4	Input 4	
IN_COM	Input common port	

8. Analog Quantity Output

PCE-N45F supply many types of analog signals which with proportional output according to the weight of the scale

Pins	Signal	Note
VOUT	Voltage output	Output resistance 0~600Ω, output can be: 0~+5V; 0~+10V; -5V~+5V; -10V~+10V;
GND	Voltage output	
IOUT	Electric current output	Output can be: 4mA~20mA; 0mA~20mA; 0mA~24mA
GND	Voltage output GND	
SHLD	Shield	

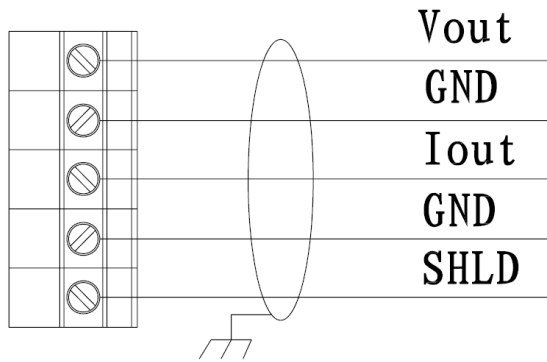

9. Parameter Set





9.1 Enter setting menu

On weighing mode, keep pressing  key to enter parameter setting mode.



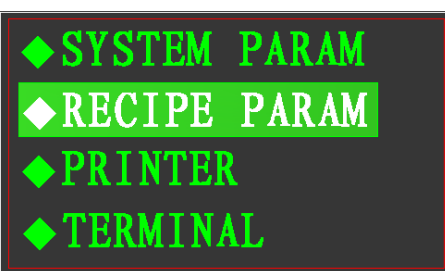

9.2 Quit Setting

On any mode, continuous press  key to return to previous step or quit the setting mode.

9.3 Main Set Menu

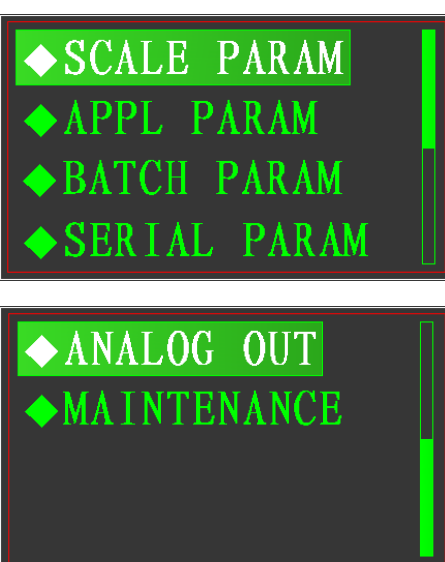
	<p>Press  key or  key to select the menu to be set, press  key to enter secondary menu, press  key to quit the set</p>
---	--

9.4 System Parameter Set

	<p>Press  key or  key to select the menu to be set, press  key to enter the chosen menu, press  key to return to previous step.</p>
---	---

9.4.1 Scale Set

	<p>Press key or key to select the menu to be set, press key to enter the chosen menu, press key to return to previous step.</p>
	<p> key to return to previous step.</p>





Max. capacity

	<p>Range: 1~200000. Default: 100.</p> <p>Press key to move the cursor, press key to change the chosen digits, press key to save to return to previous step.</p> <p>Press key to return to previous step without change</p>
--	--





Division

	<p>Division to be chosen: 0.0001, 0.0002, 0.0005, 0.001, 0.002, 0.005, 0.01, 0.02, 0.05, 0.1, 0.2, 0.5, 1, 2, 5. Default: 0.001</p> <p><i>Note: Only the below two conditions ok, the chosen division can be accepted:</i></p> <p>1: $1000 \leq \text{F.S.} / \text{Division} < 20000$.</p> <p>2: $\text{F.S.} / \text{Division} = \text{multiple of } 100$.</p> <p>Press or key to change the division, Press Enter to save and return, press key to return without change</p>
--	--

Calibration Unit

<p>◆ CAL. UNIT</p> <hr/> <p>kg</p>	<p>Press  or  key to change the division, Press  Enter to save and return, press  key to return without change</p>
------------------------------------	---





Zero Calibration





<p>◆ CAL. ZERO</p> <hr/> <p>CAL. ZERO? ✕</p>	<p>Press  key to return without change</p> <p>Press  or  key to choose J or X, If J chosen, press  key to enter zero calibration, or return directly.</p>
--	---

<p>◆ CAL. ZERO</p> <hr/> <p>EMPTY SCALE?</p>	<p>When there is nothing on the scale and it's stable, press  key to start zero calibration.</p>
--	---

<p>◆ CAL. ZERO</p> <hr/> <p>PROGRESS 60%</p>	<p>The indicator is sampling the A/D data of zero point, it ends when it became 0% from 100%.</p>
--	---

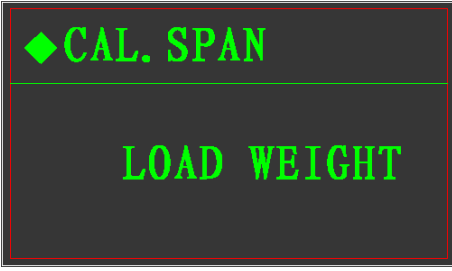
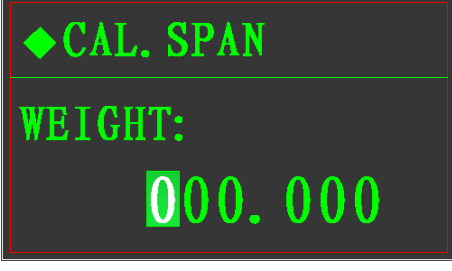
Weight Calibration



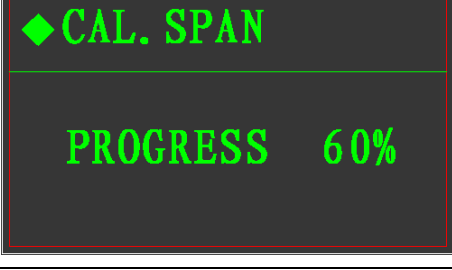
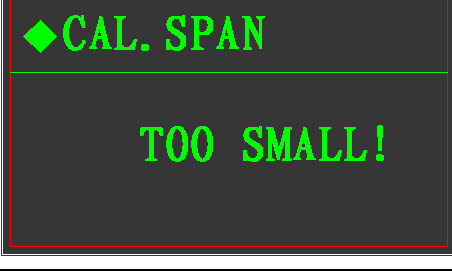
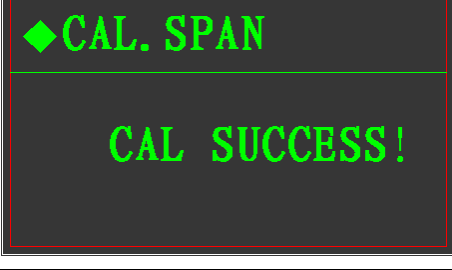

<p>◆ CAL. SPAN</p> <hr/> <p>CAL. SPAN? ✕</p>	<p>Press  key to return without change</p> <p>Press  or  key to choose J or X, If J chosen, press  key to enter weight calibration, or return directly.</p>
--	---

 <p>◆ CAL. SPAN</p> <hr/> <p>LOAD WEIGHT</p>	<p>Put the weight on the scale</p>
 <p>◆ CAL. SPAN</p> <hr/> <p>WEIGHT:</p> <p>000.000</p>	<p>Input the weight value the same as the calibration weight</p> <p>Press  key to move the cursor.</p> <p>Press  key to change the digits.</p> <p>Press  key to save the change and start to calibrate.</p> <p>Press  key to cancel and return.</p>
 <p>◆ CAL. SPAN</p> <hr/> <p>PROGRESS 60%</p>	<p>The indicator is sampling the A/D data of calibration point, it ends when it became 0% from 100%.</p>
 <p>◆ CAL. SPAN</p> <hr/> <p>TOO SMALL!</p>	<p>The weight value is too small.</p> <p>Trouble shooting:</p> <ol style="list-style-type: none"> 1、 The weight is really too light. 2、 Wrong connection of the signal cable or excitation cable
 <p>◆ CAL. SPAN</p> <hr/> <p>CAL SUCCESS!</p>	<p>Calibration done.</p>





Full Calibration

This calibration is jointed the zero calibration and weight (capacity) calibration, please refer to above steps.





Calibration parameters

<p>◆CHECK PARAM</p> <p>ZERO CODE:</p> <p>215789</p>	<p>This parameter can be retrieved and can be modified, after tested well, please record those three parameters for use in future.</p> <p>When the data in EEPROM get problem, reload those three parameters, it doesn't need to do calibration again.</p> <p>If the same model indicator to be changed and those three parameters reloaded, it doesn't need to do calibration, either.</p> <p>Input the weight value the same as the calibration weight</p>
<p>◆CHECK PARAM</p> <p>LOAD WEIGHT:</p> <p>010.000</p>	<p>Press  key to move the cursor.</p>
<p>◆CHECK PARAM</p> <p>SPAN CODE:</p> <p>824890</p>	<p>Press  key to change the digits.</p> <p>Press  key to save the change and enter next parameter.</p> <p>Press  key to cancel and return.</p>





Expansion Display

<p>◆EXPAND</p> <p>EXPAND? X</p>	<p>If 10 times resolution display needed, open the expand display:</p> <p>Press  key to cancel and return.</p> <p>Press  or  key to chose / or X</p> <p>Press  key to confirm and return.</p>
---------------------------------	---





9.4.2 Operation Set

<p>◆TARE ALLOW</p> <p>◆PWR-UP ZERO</p> <p>◆KEYPAD ZERO</p> <p>◆AZM RANGE</p>	<p>Press  key or  key to choose the menu to be set, press  key to enter.</p>
<p>◆MOTION</p> <p>◆FILTER</p> <p>◆BUZZER SOUND</p>	<p>Press  key to return the previous step.</p>



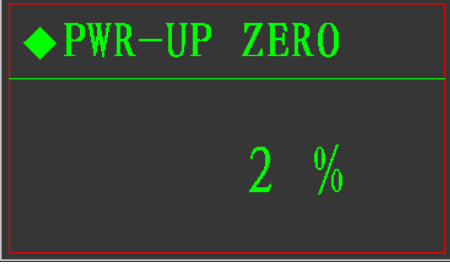

Tare Operation

	<p>Choices: Disable tare Enable tare</p> <p>Press  or  key to change</p> <p>Press  key to save and return.</p> <p>Press  key to cancel and return.</p>
---	--





Zero upon Power on

	<p>Choices: 0%, 2%, 20%</p> <p>Press  or  key to change</p> <p>Press  key to save and return.</p> <p>Press  key to cancel and return.</p>
---	---





Zero by Keypad

	<p>Choices: 0%, 2%, 20%</p> <p>Press  or  key to change</p> <p>Press  key to save and return.</p> <p>Press  key to cancel and return.</p>
--	---



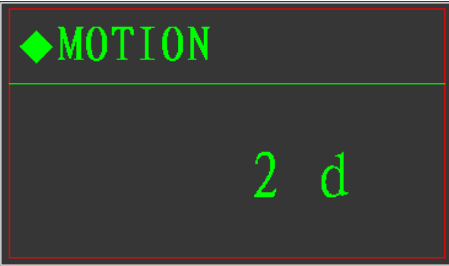

Zero Tracking

	<p>0: None; 1: 0.5d; 2: 1d; 3: 2d; 4: 3d; 5: 4d; 6: 5d;</p> <p>Press  or  key to change</p> <p>Press  key to save and return.</p> <p>Press  key to cancel and return.</p>
---	--





Vibration checking

	<p>0: None 1: Vibration checking range = 1d; 2: Vibration checking range = 2d; 3: Vibration checking range = 3d; 4: Vibration checking range = 4d; 5: Vibration checking range = 5d;</p> <p>Press  or  key to change</p> <p>Press  key to save and return.</p> <p>Press  key to cancel and return.</p>
---	---



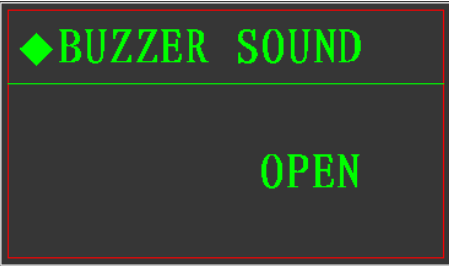

Digital filtering

	<p>Set range of 1-9, the more, the weight is more stable and the longer time to be stable. <i>Normally, if the digital filtering number set to be higher, the advance volume should be bigger, so on the batching mode, the advance volume needs to be adjusted again after the filtering number changed.</i></p> <p>Press  or  key to change</p> <p>Press  key to save and return.</p> <p>Press  key to cancel and return.</p>
--	---





Buzzer Set

	<p>On or Off</p> <p>Press  or  key to change</p> <p>Press  key to save and return.</p> <p>Press  key to cancel and return.</p>
---	--





9.4.3 Batching Set

<p>◆ WORK MODE</p> <p>◆ MATERIEL</p> <p>◆ DOORS</p> <p>◆ FEED MODE</p>	<p>Press  or  key to chose the menu to be set.</p>
<p>◆ FEED ACTION</p> <p>◆ DIS ACTION</p> <p>◆ NEAR ZERO</p> <p>◆ ADJUST FREQ</p>	<p>Press  key to enter.</p>
<p>◆ TIME PARAM</p> <p>◆ TOL FREQ</p> <p>◆ TOL RANGE</p> <p>◆ FIRST TARE</p>	<p>Press  key to return previous step.</p>
<p>◆ CYCLE TIMES</p> <p>◆ ADJUST RANGE</p>	





Batching mode:

<p>◆ WORK MODE</p> <hr/> <p>LOSE IN WT</p>	<p>Choices: 4 materials batching Single material weight lose Free setpoint.</p> <p>Press  or  key to change</p> <p>Press  key to save and return.</p> <p>Press  key to cancel and return.</p>
--	---





Material quantity

	<p>If there is no I/O board, it can be set to be 1 only. If there is the I/O board, it can be set from 1-4.</p> <p>Press  or  key to change</p> <p>Press  key to save and return.</p> <p>Press  key to cancel and return.</p>
---	---



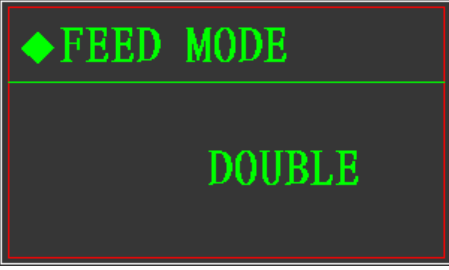

Feeding door

	<p>1: single door single speed 2: double doors double speed</p> <p>If there is no I/O board, only M1 can be set</p> <p>Press  key to move cursor.</p> <p>Press  key to modify the chosen digits.</p> <p>Press  key to save and return to previous step.</p> <p>Press  key to cancel and return to previous step.</p>
--	--

Feeding mode

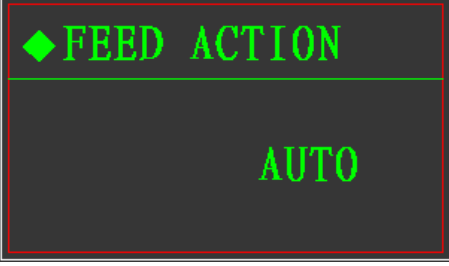
	<p>This parameter only valid for double doors and double speed All open: On fast feeding, open two doors at the same time. One open: On fast feeding, open fast feeding door.</p> <p>Press  or  key to change</p> <p>Press  key to save change and return.</p> <p>Press  key to cancel and return.</p>
---	--

Feeding action

	<p>Choice: Auto or manual</p> <p>Press  or  key to change</p> <p>Press  key to save change and return.</p> <p>Press  key to cancel and return.</p>
---	--

Discharge mode

	<p>Choice: Auto or manual</p> <p>Press or key to change</p> <p>Press key to save change and return.</p> <p>Press key to cancel and return.</p>
--	--

Empty scale range

	<p>Choice: 0%~9.9%×F.S</p> <p>Only the weight on the scale is less than this range and the cursor and output is effective, otherwise it's taken as not empty.</p> <p>Press key to move cursor.</p> <p>Press key to modify the chosen digits.</p> <p>Press key to save and return to previous step.</p> <p>Press key to cancel and return to previous step.</p>
--	--





Frequency Adjust

	<p>Choice: 0~9</p> <p>When it set to be 0, it means no adjust</p> <p>Press or key to change</p> <p>Press key to save change and return.</p> <p>Press key to cancel and return.</p>
--	--





Time Parameter

	<p>Press key or key to choose the menu to be set, press key to enter.</p> <p>Press key to return the previous step.</p>
--	---





Delay start time

	<p>Choice: 0.0~9.9 seconds</p> <p>After batching start, after the delay time, it can start to tare, open the door and start to feed.</p> <p>Press  key to move cursor.</p> <p>Press  key to modify the chosen digits.</p> <p>Press  key to save and return to previous step.</p> <p>Press  key to cancel and return to previous step.</p>
---	---

Comparing time forbidden

	<p>Choice: 0.0~9.9 seconds</p> <p>The comparing time of fast and fine feeding both to be set in this menu.</p> <p>Press  key to move cursor.</p> <p>Press  key to modify the chosen digits.</p> <p>Press  key to save and return to previous step.</p> <p>Press  key to cancel and return to previous step.</p>
--	--

Delay checking time

	
<p>Press  key or  key to choose</p> <p>Choice: 0.0~9.9 seconds, the stabling time after batching finish of material 1</p>	

the menu to be set, press  key to enter.

Press  key to return the previous step.



Choice: 0.0~9.9 seconds, the stabling time after batching finish of material 2



Choice: 0.0~9.9 seconds, the stabling time after batching finish of material 3



Choice: 0.0~9.9 seconds, the stabling time after batching finish of material 4

Delay time of discharge





Choice: 0.0~9.9 seconds.

When it reach to the range of empty scale, it will close the door after this time, to make sure full discharge.

Press  key to move cursor.

Press  key to modify the chosen digits.

Press  key to save and return to previous step.

Press  key to cancel and return to previous step.

Tolerance checking frequency

<p>◆ TOL_FREQ 1</p>	<p>Choice: 0~99 Checking tolerance after the times of batching, if it was set of 0, it will not check.</p> <p>Press or key to change</p> <p>Press key to save change and return.</p> <p>Press key to cancel and return.</p>
-------------------------	---

Tolerance range set

<p>◆ TOL_RANGE 1.0 %</p>	<p>Choice: 0%~9.9%×Target weight When it checking, if value of the actual weight minus the target weight is less than this value, it will be taken as ok, if not, it's out of tolerance range.</p> <p>Press key to move cursor.</p> <p>Press key to modify the chosen digits.</p> <p>Press key to save and return to previous step.</p> <p>Press key to cancel and return to previous step.</p>
------------------------------	---

First material tare

<p>◆ FIRST_TARE FIRST TARE? X</p>	<p>×: The first material doesn't need tare √: The first material need tare</p> <p>Press or key to change</p> <p>Press key to save change and return.</p> <p>Press key to cancel and return.</p>
---------------------------------------	---

Cycle times of batching

<p>◆ CYCLE_TIMES 1</p>	<p>It will stop after this cycle times.</p> <p>Press or key to change</p> <p>Press key to save change and return.</p> <p>Press key to cancel and return.</p>
----------------------------	--

Adjust range

	<p>Choice: 0%~9.9%×Target weight Only the value of actual weight minus target weight is less this range, it goes to adjust, when it's set to be 0, this function off.</p> <p>Press key to move cursor.</p> <p>Press key to modify the chosen digits.</p> <p>Press key to save and return to previous step.</p> <p>Press key to cancel and return to previous step.</p>
--	--





9.4.4 Communication protocol

	<p>Press key or key to choose the menu to be set, press key to enter.</p> <p>Press key to return the previous step.</p>
--	---



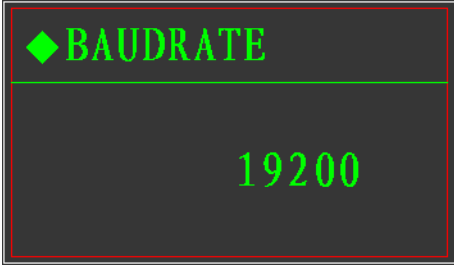

Output mode

	<p>No output Continuous output format A Command output format A Continuous output format B Command output format B MODBUS RTU output</p> <p>Press or key to change</p> <p>Press key to save change and return.</p> <p>Press key to cancel and return.</p>
--	---





Baud rate

 <p>◆ BAUDRATE</p> <hr/> <p>19200</p>	<p>Choice: 300 bit/s; 600 bit/s; 1200 bit/s; 2400 bit/s; 4800 bit/s; 9600 bit/s; 19200 bit/s; 38400 bit/s; 57600 bit/s; 115200 bit/s;</p> <p>Press  or  key to change</p> <p>Press  key to save change and return.</p> <p>Press  key to cancel and return.</p>
--	---



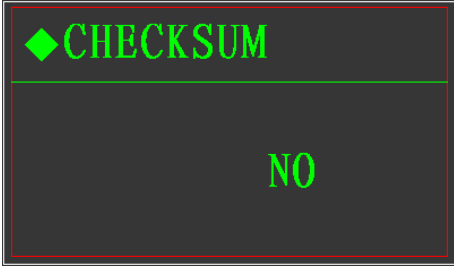

Parity check



 <p>◆ PARITY</p> <hr/> <p>8 BIT NONE</p>	<p>Choice: 8 digits no parity check 7 digits even parity check 7 digits odd parity check 8 digits even parity check 8 digits odd parity check</p> <p>Press  or  key to change</p> <p>Press  key to save change and return.</p> <p>Press  key to cancel and return.</p>
---	---

Checksum





 <p>◆ CHECKSUM</p> <hr/> <p>NO</p>	<p>Choice: No transmitting Transmitting</p> <p>Press  or  key to change</p> <p>Press  key to save change and return.</p> <p>Press  key to cancel and return.</p>
---	---

Indicator address





 <p>◆ NODE ADDRESS</p> <hr/> <p>10</p>	<p>Choice: 1–64 Keep the uniqueness of address in the same network</p> <p>Press  key to move cursor.</p> <p>Press  key to modify the chosen digits.</p> <p>Press  key to save and return to previous step.</p>
---	--

	 Press  key to cancel and return to previous step.
--	---







9.4.5 Analog quantity output

	Press  key or  key to choose the menu to be set, press  key to enter. Press  key to return the previous step.
---	--

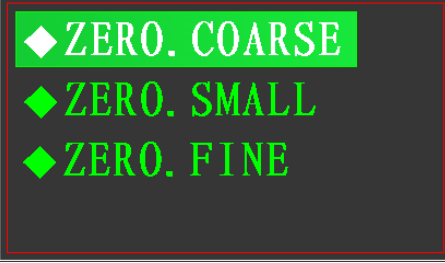
Output type choose

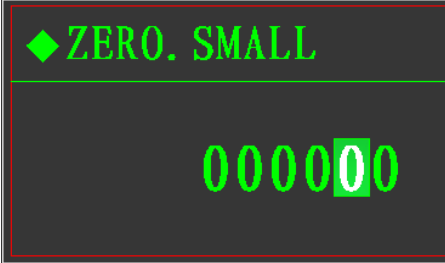
	Choice: 0 ~ +5V; 0 ~ +10V; -5V ~ +5V; -10V ~ +10V; 4mA ~ 20mA; 0mA ~ 20mA; 0mA ~ 24mA; Press  or  key to change Press  key to save change and return. Press  key to cancel and return.
--	--

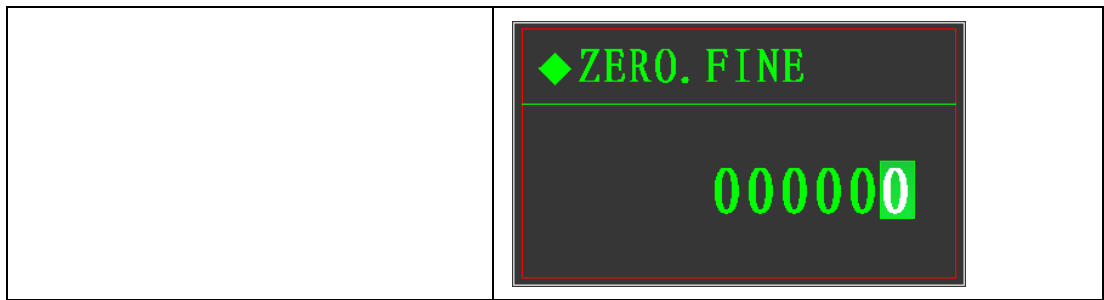

Zero calibration (coarse-small-fine)

	
	
Press  key or  key to choose the menu to be set, press  key to enter. Press  key to return the previous step.	





Full scale calibration (coarse-small-fine)

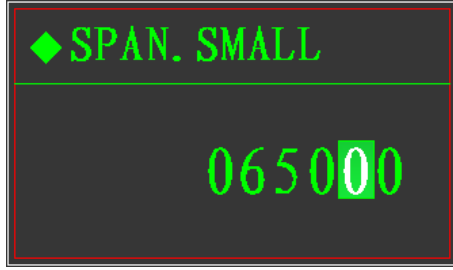

Press  key or  key to choose the menu to be set, press  key to enter.

Press  key to return the previous step.



9.4.6 Diagnosis and maintenance













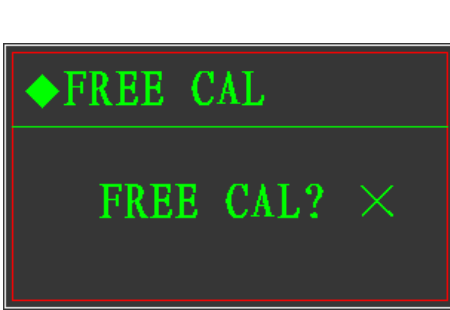

Press  key or  key to choose the menu to be set, press  key to enter.









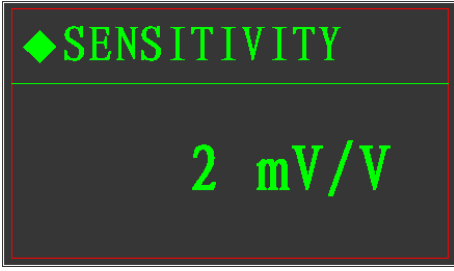

Press  key to return the previous step.

Reload

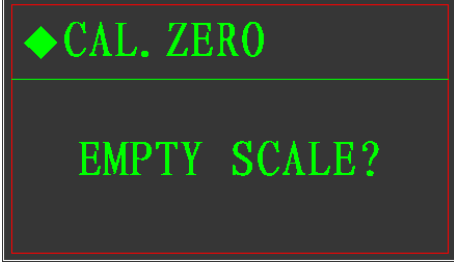
	Choose \mathcal{J} to reload the default parameters
	Reloading...

Free calibration

	Choose \mathcal{J} to enter
	<p>Menus</p> <p>Press  key or  key to choose the menu to be set, press  key to enter.</p> <p>Press  key to return the previous step.</p>
	<p>Input the full capacity of load cells</p> <p>Press  key to move cursor.</p> <p>Press  key to modify the chosen digits.</p> <p>Press  key to save and return to previous step.</p> <p>Press  key to cancel and return to previous step.</p>

	<p>Input the sensitivity of load cells</p> <p>Press  or  key to change</p> <p>Press  key to save change and return.</p> <p>Press  key to cancel and return.</p>
	<p>Zero calibration</p>
	
	<p>Adjust the present weight manually</p> <p>Press  key to move cursor.</p> <p>Press  key to modify the chosen digits.</p> <p>Press  key to save and return to previous step.</p> <p>Press  key to cancel and return to previous step.</p>

Input interface test

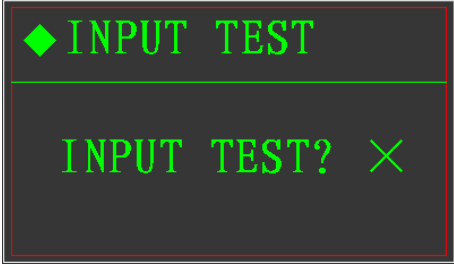
	<p>Choose / to enter test menu</p>
---	------------------------------------

	Input test interface
--	----------------------

Output interface test

	Choose / to enter test menu
	Output test interface

Backup parameters



	Choose / to backup parameters
	Input the password



<p>◆ BACKUP PASSWORD ERROR!</p>	Password wrong
<p>◆ BACKUP BACKUP.....</p>	Backup

Retrieve the backup parameters











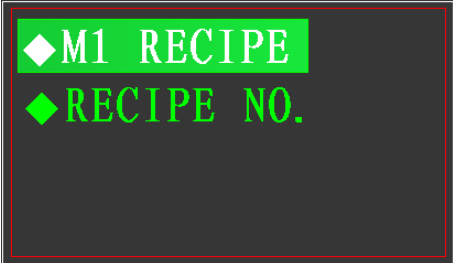





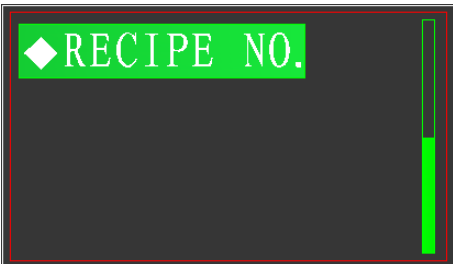

<p>◆ RELEASE RELEASE? X</p>	Choose / to retrieve the backup parameters
<p>◆ RELEASE NOT BACKUP!!</p>	Indicates that there is no backup parameters
<p>◆ RELEASE RELEASE.....</p>	Retrieving...

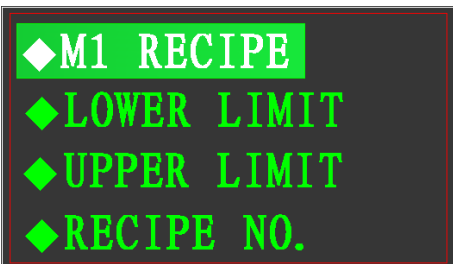
Alternate output mapping

<p>◆ OUT MAPPING TOL</p>	<p>Choices: Tolerance output, fast feeding output, fine feeding output, discharging output. If the original output interface broken or with problem, you can mapping that interface to this alternate one by changing the cables.</p> <p>Press  or  key to change</p>
------------------------------	---

	 Press key to save change and return.
	 Press key to cancel and return.





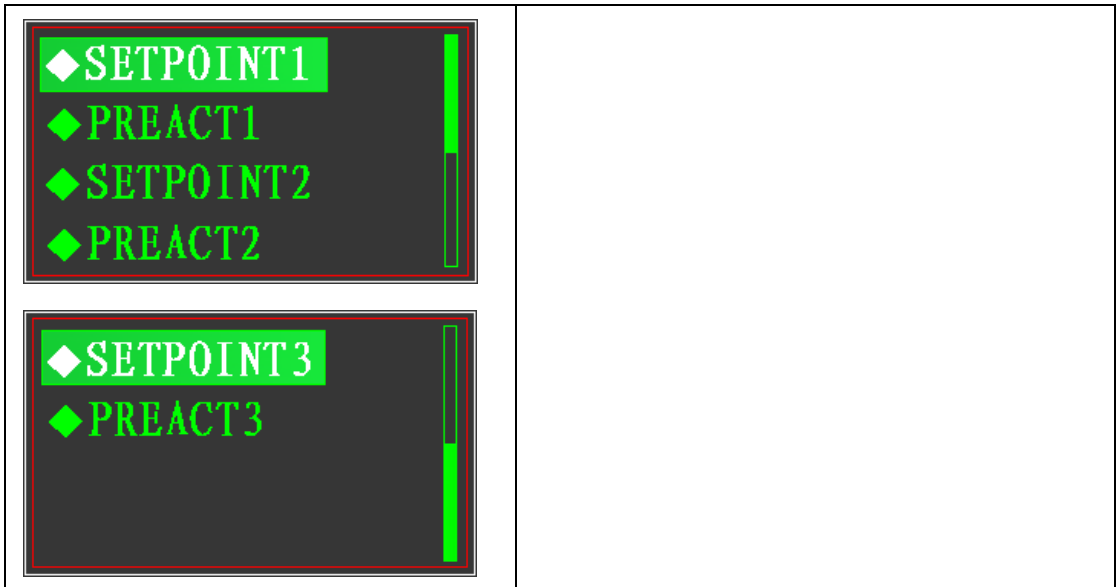

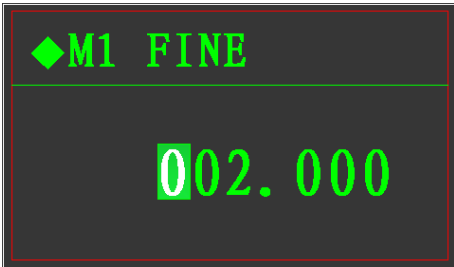

9.5 Recipes Parameters set

<p><i>Basic + 4 materials type</i></p> 	<p>Press  key or  key to choose the menu to be set, press  key to enter.</p> <p>Press  key to return the previous step.</p>
<p><i>IO + 4 materials type</i></p>  	<p>Press  key or  key to choose the menu to be set, press  key to enter.</p> <p>Press  key to return the previous step.</p>
<p><i>Basic + 1 material weight losing</i></p> 	<p>Press  key or  key to choose the menu to be set, press  key to enter.</p> <p>Press  key to return the previous step.</p>
<p><i>Basic + setpoints</i></p>	<p>Press  key or  key to choose the menu to be set, press  key to enter.</p> <p>Press  key to return the previous step.</p>



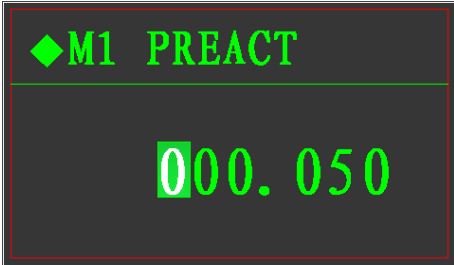



M1 recipe set

<p>◆ M1 TARGET ◆ M1 FINE ◆ M1 PREACT</p>	<p>Press key or key to choose the menu to be set, press key to enter.</p> <p>Press key to return the previous step.</p>
<p>◆ M1 TARGET</p> <p>010.000</p>	<p>Target weight: The final weight filled in the tank/container, etc.</p> <p>Press key to move cursor.</p> <p>Press key to modify the chosen digits.</p> <p>Press key to save and return to previous step.</p> <p>Press key to cancel and return to previous step.</p>



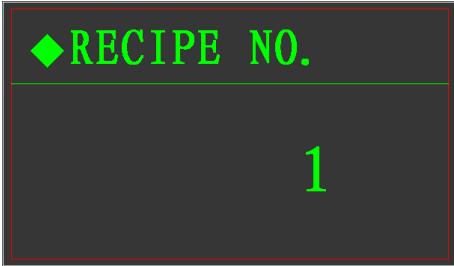

 <p>◆M1 FINE 002.000</p>	<p>Fine weight: The relative weight between TARGET and FAST (when it finish the fast filling and change to fine filling), it's the relative value but not actual value.</p> <p>Press  key to move cursor.</p> <p>Press  key to modify the chosen digits.</p> <p>Press  key to save and return to previous step.</p> <p>Press  key to cancel and return to previous step.</p>
 <p>◆M1 PRACT 000.050</p>	<p>PRACT: Decide the weight of end of the fine feeding (TARGET — PRACT).</p> <p>Press  key to move cursor.</p> <p>Press  key to modify the chosen digits.</p> <p>Press  key to save and return to previous step.</p> <p>Press  key to cancel and return to previous step.</p>

M2, M3, M4 recipes the same as M1



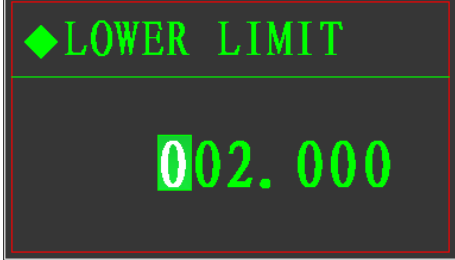
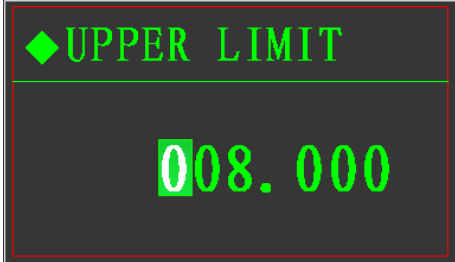

Recipe numbers set

 <p>◆RECIPE NO. 1</p>	<p>One number can preset of 3 recipes If a new recipe, you need to set the recipe number, if it's the recipe already in the indicator, you can modify it directly.</p> <p>Press  or  key to change</p> <p>Press  key to save change and return.</p> <p>Press  key to cancel and return.</p>
--	---

Upper and lower weight limitations

	<p>It needed to be set when it using for losing weight filling</p>
	<p>Lower limitation: the minimum remaining after the end of discharging. Upper limitation: the approximated maximum weight it can reach.</p>
	<p>During feeding, if the weight $< (\text{target} + \text{lower limitation})$, the indicator will open the supplement feeding valve until the weight reach to upper limitation and then start to discharge.</p>
	<p>Note: If the target weight $< (\text{Upper limitation} - \text{Lower limitation})$, every start will end after once time discharge.</p>
	<p>If the target weight $> (\text{Upper limitation} - \text{Lower limitation})$, it will discharge more times until it reach to the target value.</p>
	<p>Press  key to move cursor.</p>
	<p>Press  key to modify the chosen digits.</p>
	<p>Press  key to save and return to previous step.</p>
	<p>Press  key to cancel and return to previous step.</p>

Setpoint 1

	<p>Press  key to move cursor.</p>
	<p>Press  key to modify the chosen digits.</p>
	<p>Press  key to save and return to previous step.</p>
	<p>Press  key to cancel and return to previous step.</p>

Setpoint 2 and setpoint 3 the same as above set.

Preaction 1 set

<p>◆ PREACT1 000.020</p>	<p>Press key to move cursor.</p> <p>Press key to modify the chosen digits.</p> <p>Press key to save and return to previous step.</p> <p>Press key to cancel and return to previous step.</p>
------------------------------	--









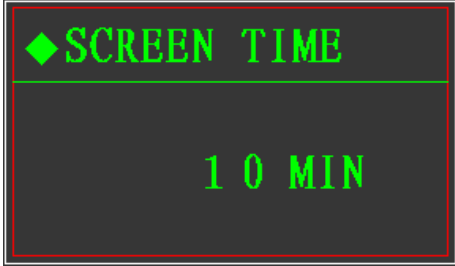

Preaction 2 and preaction 3 the same set as above

9.6 Printing table format

<p>◆ PRINT ALLOT ◆ PRINT TOTAL ◆ PRINT RECIPE</p>	<p>Press key or key to choose the menu to be set, press key to enter.</p> <p>Press key to return the previous step.</p>
---	---

9.7 System set

<p>◆ LANGUAGE ◆ SCREEN TIME ◆ CONTRAST</p>	<p>Press key or key to choose the menu to be set, press key to enter.</p> <p>Press key to return the previous step.</p>
<p>◆ LANGUAGE ENGLISH</p>	<p>Language set</p> <p>Press key or key to choose the menu to be set, press key to enter.</p> <p>Press key to return the previous step.</p>

	<p>Screensaver time set If it's set to be 0, the function off</p> <p>Press  key or  key to choose the menu to be set, press  key to enter.</p> <p>Press  key to return the previous step.</p>
	<p>Screen contrast adjust, the bigger number, the more bright the screen.</p> <p>Press  or  key to change</p> <p>Press  key to save change and return.</p> <p>Press  key to cancel and return.</p>

10. Appendix: Communication Protocol

10.1 Command transmitting Format A

Data format (18 bytes)																	
STX	A	B	C	X	X	X	X	X	X	X	X	X	X	X	X	CR	CKS
I	II			III						IV						V	VI

I、<STX>ASCII start sign (02H)。

II、status A、B、C, refer to below table

III、Weight value, gross weight or net weight, 6 ASCII digits without sign and decimal point.

IV、Tare value, 6 ASCII digits without sign and decimal point.

V、<CR>ASCII Enter sign (0DH)。

VI、<CKS> checksum

BIT	Status A	Status B	Status C
Bit0	Decimal point position: 001:XXXXX0 010:XXXXXX 011:XXXXX.X 100:XXXX.XX 101:XXX.XXX	0=Current value is gross 1=Current value is net	000 : Stop 001 : Material 1 feed 010 : Material 2 feed 011 : Material 3 feed 100 : Material 4 feed 101 : Discharging 110 : Batching Suspense 111 : Batching run
Bit1		0=Display value is positive 1=Display value is negative	
Bit2		0=Within display range 1=Out of display range	
Bit3	Fast feed output 0=Off 1=On	0=Current weighing stable 1=Current weighing unstable	Always 0
Bit4	Fine feed output 0=Off 1=On	Always 1	0 : stand display 1 : ×10 display

Bit5	Always 1	Always 1	
Bit6	Always 0	Always 0	
Bit7	Always 0	Always 0	

10.2 Command transmitting format A

No.	Command sign	Note
1	“C” or “c”	Clear tare
2	“P” or “p”	Print gross tare net
3	“T” or “t”	Tare
4	“Z” or “z”	Zero

10.3 Continuous transmit format B

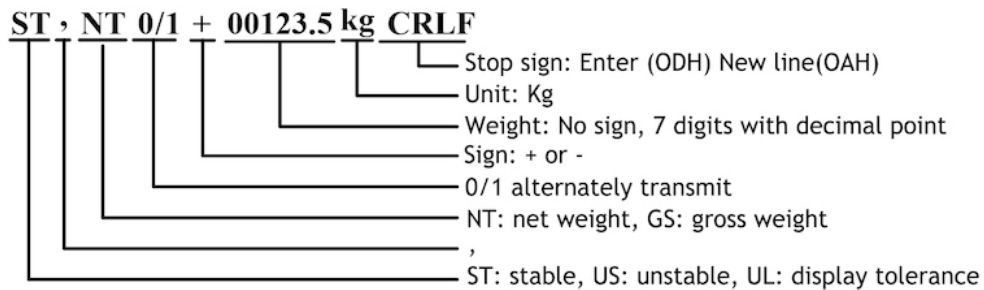

10.4 Command output format B

No.	Command letter	Indicator response
1	READ+ENTER NEWLINE	Refer to <Indicator weight reading and status>
2	TARE+ ENTER NEWLINE	Refer to <Tare weight reading and status>
3	TARE ON+ ENTER NEWLINE	Tare operation Works: return YES+ ENTER NEWLINE No work: return NO? + ENTER NEWLINE
4	TARE OFF+ ENTER NEWLINE	Clear tare Works: return YES+ ENTER NEWLINE No work: return NO? + ENTER NEWLINE
5	ZERO ON+ ENTER NEWLINE	Zero operation Works: return YES+ ENTER NEWLINE No work: return NO? + ENTER NEWLINE
6	CAL XXXXX+ ENTER NEWLINE	XXXXXX is loading weight value, W, without decimal point If W=0, zero calibration. If W≠0, loading weight calibration. Indicator response: Zero calibration done: ZERO YES+ ENTER NEWLINE Zero calibration vibrate: ZERO E1+ ENTER NEWLINE Loading weight calibration done SPAN YES+ ENTER NEWLINE Loading weight calibration vibrate:

		SPAN E1+ ENTER NEWLINE Input data is too small: SPAN E2+ ENTER NEWLINE Input data is too big: SPAN E3+ ENTER NEWLINE Loading weight is too big: SPAN E4+ ENTER NEWLINE
--	--	--

Indicator weight reading and status, the indicator response format:

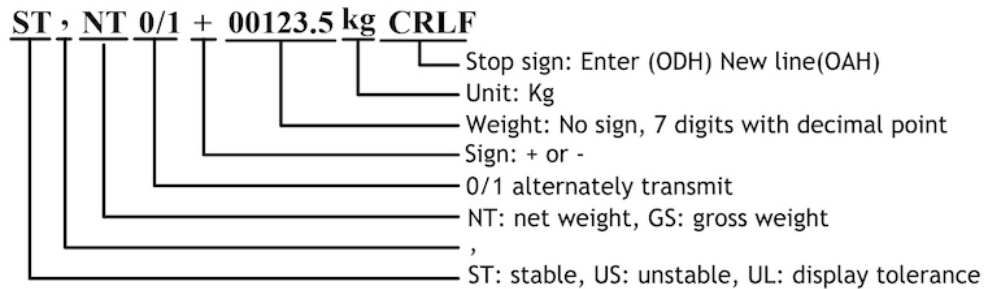

Tare weight reading and status, the indicator response:

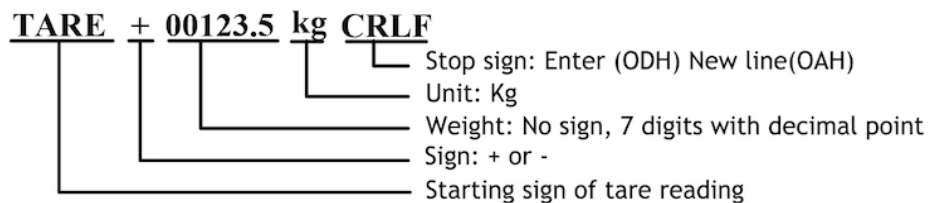

10.5 MODBUS output format

MODBUS is the master-slave type network communication protocol, this indicator acts as the subordinate in the network for called by the host system, the format is RTU and support 03 and 06 functions. The parameter needs to be set as F4.1=5 and the address of Modbus to set in F4.5, the mapping address definitions as the below table:

Address	Digits	Note (read only)
40001		Current gross weight value
40002		Current display weight value
40003	.0	1=material 1 in fast feeding
	.1	1=material 1 in fine feeding
	.2	1=scale is empty
	.3	1=reach to setpoint 1 (setpoint type)
	.4	1=material 2 in fast feeding
	.5	1=material 2 in fine feeding
	.6	1=reach to setpoint 2 (setpoint type)
	.7	1=reach to setpoint 3 (setpoint type)
	.8	1=material 3 in fast feeding
	.9	1=material 3 in fine feeding
	.10	1=supplement feeding (single material losing weight mode)
	.11	1=Indicator above tolerance or lower than tolerance
.12	1=material 4 in fast feeding	

	.13	1=material 4 in fine feeding
40004	.0	01~11: current recipe numbers (1~3)
	.1	
	.2	
	.3	
	.4	
	.5	1=batching suspense
	.6	1=discharging
	.7	1=feeding finish, waiting for discharging
	.8	0000=0.001; 0011=0.01; 0110=0.1; 1001=1; 0001=0.002; 0100=0.02; 0111=0.2; 1010=2; 0010=0.005; 0101=0.05; 1000=0.5; 1011=5; 1100=10; 1101=20; 1110=50; current division.
	.9	
	.10	
	.11	
	.12	1=batching tolerance
	.13	1=scale vibrate
	.14	1=manual feeding mode
.15	1=manual discharging mode	
40005		1~4 material batching mode: actual batched weight of current material 1. Single material losing weight mode: the current batched value of this filling. (the batching value kept till start of next cycle).
40006		1~4 material batching mode: actual batched weight of current material 2. Single material losing weight mode: the current accumulated value of this filling. (the batching value kept till start of next cycle).
40007		actual batched weight of current material 3. (the batching value kept till start of next cycle).
40008		actual batched weight of current material 4. (the batching value kept till start of next cycle).
Address	Mapping (read and write)	
40009	Tare value	
40010	Target value of material 1	
40011	Target value of material 2	
40012	Target value of material 3	
40013	Target value of material 4	
40014	Fast feeding value of material 1	
40015	Fast feeding value of material 2	
40016	Fast feeding value of material 3	
40017	Fast feeding value of material 4	
40018	Preaction quantity of material 1	
40019	Preaction quantity of material 2	
40020	Preaction quantity of material 3	
40021	Preaction quantity of material 4	
40022	Range of empty scale	
40023	Preaction adjust frequency	
40024	Start delay time	
40025	Discharge delay time	
40026	Forbid comparing time	
40027	Delay check time of material 1	
40028	Delay check time of material 2	
40029	Delay check time of material 3	
40030	Delay check time of material 4	
40031	Lower tank weight	
40032	Upper tank weight	
40033	Weight value of setpoint 1	
40034	Weight value of setpoint 2	
40035	Weight value of setpoint 3	
40036	Preaction quantity of setpoint 1	

40037		Preaction quantity of setpoint 2
40038		Preaction quantity of setpoint 3
40039		Quantity used of material 1 (higher digits)
40040		Quantity used of material 1 (lower digits)
40041		Quantity used of material 2 (higher digits)
40042		Quantity used of material 2 (lower digits)
40043		Quantity used of material 3 (higher digits)
40044		Quantity used of material 3 (lower digits)
40045		Quantity used of material 4 (higher digits)
40046		Quantity used of material 4 (lower digits)
40047	0	1=Zero calibration done
	1	1=Loading weight calibration done
	2	1=Writing value less than 1% during loading weight calibration
	3	1=Writing value more than full scale during loading weight calibration
	4	1=Loading weight is not enough during loading weight calibration
5	1=running, calibration not allowed	
40048		Floating number of current weight
40049		
Address		Mapping (Write only)
40101	.0	0001~0100: appoint the material number to be operated
	.1	
	.2	
	.3	
	.4	Start manual feeding, material bits 0-3 given: (Eg: If 0001: material 1 batching, If 0010: material 2 batching, If 0011: material 3 batching, If 0100: material 4 batching)
	.5	/
	.6	/
	.7	/
	.8	Start auto feeding
	.9	Suspend batching or discharging
	.10	Stop emergency
	.11	Start discharge (after feeding end and discharging type is manual)
	.12	Tare (not batching, not vibrate and tare allowed)
	.13	Clear tare (not batching, not vibrate and tare allowed)
	.14	Zero (not batching, not vibrate)
.15	Continue batching or discharging	
40102	.0	0001~0011: Choose working recipe number
	.1	
	.2	
	.3	
	.4	10: Chose manual batching during all cycles.
	.5	11: Chose auto batching during all cycles.
	.6	10: Chose manual discharging during all cycles.
.7	11: Chose auto discharging during all cycles.	
40103		Scale calibration: 0: Zero calibration XXXXX: loading weight calibration (XXXXX is the value of the loading weight)

10.6 Multi materials jointed work with relay connected

The below chart is for connecting of 4 materials batching, the input and output can be connected as common source or common grounded, for single material, connect the three relay to the connecting terminals of fast feeding, fine feeding and discharging.

