



User Manual

PCE-PHM 14 Water Analysis Meter



User manuals in various languages (français, italiano, español, português, nederlands, türk, polski, русский, 中文) can be found by using our product search on: www.pce-instruments.com

Last change: 2 May 2018
v1.0



Contents

1	Safety notes	1
2	Features	2
3	Applications	2
4	Specifications	2
5	Front Panel Description	3
6	Calibration	3
7	Important information on the calibration	5
8	Clear calibration	6
9	Measuring procedure	6
10	Delivery contents	7
11	Contact	7
12	Disposal	7

1 Safety notes

Please read this manual carefully and completely before you use the device for the first time. The device may only be used by qualified personnel and repaired by PCE Instruments personnel. Damage or injuries caused by non-observance of the manual are excluded from our liability and not covered by our warranty.

- The device must only be used as described in this instruction manual. If used otherwise, this can cause dangerous situations for the user and damage to the meter.
- The instrument may only be used if the environmental conditions (temperature, relative humidity, ...) are within the ranges stated in the technical specifications. Do not expose the device to extreme temperatures, direct sunlight, extreme humidity or moisture.
- Do not expose the device to shocks or strong vibrations.
- The case should only be opened by qualified PCE Instruments personnel.
- Never use the instrument when your hands are wet.
- You must not make any technical changes to the device.
- The appliance should only be cleaned with a damp cloth. Use only pH-neutral cleaner, no abrasives or solvents.
- The device must only be used with accessories from PCE Instruments or equivalent.
- Before each use, inspect the case for visible damage. If any damage is visible, do not use the device.
- Do not use the instrument in explosive atmospheres.
- The measurement range as stated in the specifications must not be exceeded under any circumstances.
- Non-observance of the safety notes can cause damage to the device and injuries to the user.

We do not assume liability for printing errors or any other mistakes in this manual.

We expressly point to our general guarantee terms which can be found in our general terms of business.

If you have any questions please contact PCE Instruments. The contact details can be found at the end of this manual.



2 Features

- Multi-purpose pH meter
- Backlit display
- Auto calibration
- Compact and lightweight

3 Applications

- Aquariums
- Drinks
- Fish hatcheries
- Food processing
- Photography
- Laboratory
- Quality control
- Schools
- Pools
- Water treatment

4 Specifications

Measuring range	0 ... 14 pH
Resolution	0.01 pH
Accuracy (at 23 °C ± 5 °C / after calibration)	0.07 pH at 5 ... 9 pH 0.1 pH at 4 .. 10 pH 0.2 pH at 1 ... 3,9 pH & 10,1 ... 13 pH
Input impedance	1012 Ohm
Sampling rate	approx. 1 second
Operating conditions	0 ... 50 °C / 32 ... 122 °F; < 80 % RH
Calibration	internally at pH7; pH 4 and pH 10
Power supply	externally 9 V
Current consumption	approx. 11 mA
Dimensions	89 x 57 x 31 mm / 3.5 x 2.2 x 1.2"
Weight	approx. 117 g / 4.1 oz
pH electrode connection	BNC

5 Front panel description

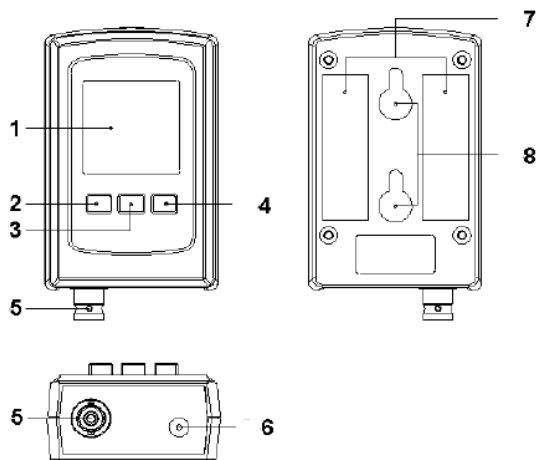

1. Display
2. CAL / ENTER key
3. ESC key
4. ▼ (Down) key
5. pH electrode BNC socket
6. DC 9 V input socket
7. Positioning aid for adhesive pads
8. Apertures for fixing

6 Calibration

Prerequisites for calibration

- Ideally, the electrode will produce 0 mV at pH 7.00
- The ideal ambient temperature is 25 °C

Required equipment for calibration

- pH Electrode
- 2 pH solutions (pH 7.00 and pH 4.00)



Calibration procedure pH 7

- 1) Rinse the electrode in distilled water completely.
- 2) Connect the pH electrode to the meter and immerse it into the relevant calibration solution.
- 3) Power on the instrument.
- 4) Press the "CAL" key. The desired calibration value pH 7 will appear.

The display will show:

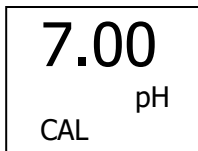

- 5) Press the "ENTER" key to confirm.

Calibration procedure pH 4

- 1) Rinse the electrode in distilled water completely.
- 2) Connect the pH electrode to the meter and immerse it into the relevant calibration solution.
- 3) Power on the instrument.
- 4) Press the "CAL" key. The desired calibration value pH 7 will appear.

The display will show:

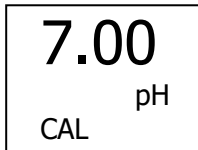

- 5) Press the ▼ (Down) key until the desired calibration value appears:

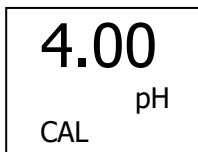

- 6) Press the "ENTER" key to confirm.

Calibration procedure pH 10

- 1) Rinse the electrode in distilled water completely.
- 2) Connect the pH electrode to the meter and immerse it into the relevant calibration solution.
- 3) Power on the instrument.
- 4) Press the "CAL" key. The desired calibration value pH 7 will appear.

The display will show:

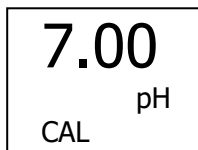

- 5) Press the ▼ (Down) key until the desired calibration value appears:

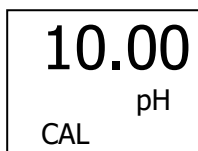

- 6) Press the "ENTER" key to confirm.

7 Important information on the calibration

- Before and after immersing the electrode into a pH solution, rinse it with distilled water.
- Calibrate each pH solution twice, if possible.
- It is recommended to calibrate in two steps: pH 7 first, followed by pH 4, then calibrate pH 7 again and then pH 10.
- If the calibration solution deviates by 2 pH, "ERR" will appear in the display.

8 Clear calibration

- 1) Power on the instrument.
- 2) Press the "CAL" key.

The following will be shown in the display:

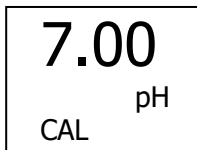

7.00
pH
CAL

3. Press the ▼ (Down) key until the following appears:

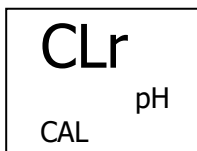

CLr
pH
CAL

4. Press the "ENTER" key to confirm.
When the calibration has been cleared, the display will show:

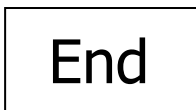

End

9 Measuring procedure

- 1) Power on the instrument.
- 2) Immerse the electrode into the desired solution.
- 3) The instrument will display the measured pH value.
- 4) Rinse the electrode with distilled water.

10 Delivery contents

- 1 x pH Meter PCE-PHM 14
- 1 x pH electrode
- 2 x adhesive pads
- 1 x 9 V power adapter
- 1 x user manual

11 Contact

If you have any questions, suggestions or technical problems, please do not hesitate to contact us. You will find the relevant contact information at the end of this user manual.

12 Disposal

For the disposal of batteries in the EU, the 2006/66/EC directive of the European Parliament applies. Due to the contained pollutants, batteries must not be disposed of as household waste. They must be given to collection points designed for that purpose.

In order to comply with the EU directive 2012/19/EU we take our devices back. We either re-use them or give them to a recycling company which disposes of the devices in line with law.

For countries outside the EU, batteries and devices should be disposed of in accordance with your local waste regulations.

If you have any questions, please contact PCE Instruments.





PCE Instruments contact information

Germany

PCE Deutschland GmbH
Im Langel 4
D-59872 Meschede
Deutschland
Tel.: +49 (0) 2903 976 99 0
Fax: +49 (0) 2903 976 99 29
info@pce-instruments.com
www.pce-instruments.com/deutsch

France

PCE Instruments France EURL
23, rue de Strasbourg
67250 SOULTZ-SOUS-FORETS
France
Téléphone: +33 (0) 972 3537 17
Numéro de fax: +33 (0) 972 3537 18
info@pce-france.fr
www.pce-instruments.com/french

Spain

PCE Ibérica S.L.
Calle Mayor, 53
02500 Tobarra (Albacete)
España
Tel. : +34 967 543 548
Fax: +34 967 543 542
info@pce-iberica.es
www.pce-instruments.com/espanol

United States of America

PCE Americas Inc.
711 Commerce Way suite 8
Jupiter / Palm Beach
33458 FL
USA
Tel: +1 (561) 320-9162
Fax: +1 (561) 320-9176
info@pce-americas.com
www.pce-instruments.com/us

United Kingdom

PCE Instruments UK Ltd
Units 12/13 Southpoint Business Park
Ensign Way, Southampton
Hampshire
United Kingdom, SO31 4RF
Tel: +44 (0) 2380 98703 0
Fax: +44 (0) 2380 98703 9
info@industrial-needs.com
www.pce-instruments.com/english

Italy

PCE Italia s.r.l.
Via Pesciatina 878 / B-Interno 6
55010 LOC. GRAGNANO
CAPANNORI (LUCCA)
Italia
Telefono: +39 0583 975 114
Fax: +39 0583 974 824
info@pce-italia.it
www.pce-instruments.com/italiano

The Netherlands

PCE Brookhuis B.V.
Institutenweg 15
7521 PH Enschede
Nederland
Telefoon: +31 (0)53 737 01 92
Fax: +31 53 430 36 46
info@pcebenelux.nl
www.pce-instruments.com/dutch

Chile

PCE Instruments Chile S.A.
RUT: 76.154.057-2
Santos Dumont 738, local 4
Comuna de Recoleta, Santiago, Chile
Tel. : +56 2 24053238
Fax: +56 2 2873 3777
info@pce-instruments.cl
www.pce-instruments.com/chile

Hong Kong

PCE Instruments HK Ltd.
Unit J, 21/F., COS Centre
56 Tsun Yip Street
Kwun Tong
Kowloon, Hong Kong
Tel: +852-301-84912
jyi@pce-instruments.com
www.pce-instruments.cn

China

PCE (Beijing) Technology Co.,Ltd
1519 Room, 6 Building
Men Tou Gou Xin Cheng,
Men Tou Gou District
102300 Beijing
China
Tel: +86 (10) 8893 9660
info@pce-instruments.cn
www.pce-instruments.cn

Turkey

PCE Teknik Cihazları Ltd.Şti.
Halkalı Merkez Mah.
Pehlivan Sok. No.6/C
34303 Küçükçekmece - İstanbul
Türkiye
Tel: 0212 471 11 47
Faks: 0212 705 53 93
info@pce-cihazlari.com.tr
www.pce-instruments.com/turkish