



# User Manual

PCE-VE 1000 Borescope



User manuals in various languages (Deutsch, français, italiano, español, português, nederlands, türk, polski, русский, 中文) can be downloaded here:

[www.pce-instruments.com](http://www.pce-instruments.com)

Last change: 25 October 2017  
v1.0

## Contents

<b>1</b>	<b>Safety notes</b> .....	<b>2</b>
<b>2</b>	<b>System description</b> .....	<b>3</b>
<b>3</b>	<b>Preparations</b> .....	<b>7</b>
<b>4</b>	<b>Make recordings</b> .....	<b>7</b>
4.1	Record images .....	7
4.2	Record videos .....	7
<b>5</b>	<b>SD card</b> .....	<b>7</b>
<b>6</b>	<b>Functions</b> .....	<b>7</b>
6.1	Setting the brightness.....	7
6.2	Zoom.....	8
6.3	Rotating and reflecting the image .....	8
6.4	Pre-timed video recordings.....	8
6.5	Playback function .....	8
6.6	Functions for video recording .....	9
<b>7</b>	<b>Settings</b> .....	<b>9</b>
7.1	General settings .....	9
7.2	SD card.....	9
7.3	Language .....	10
7.4	Date and time.....	10
7.5	Automatic shutdown .....	10
<b>8</b>	<b>Connectors</b> .....	<b>10</b>
<b>9</b>	<b>Maintenance</b> .....	<b>11</b>
9.1	Replacing the borescope cable .....	11
9.2	Firmware update .....	11
<b>10</b>	<b>Borescope cables</b> .....	<b>12</b>
10.1	Borescope cable with a swivelling camera.....	12
10.2	HR borescope cable.....	14
<b>11</b>	<b>Contact</b> .....	<b>21</b>
<b>12</b>	<b>Disposal</b> .....	<b>21</b>

## 1 Safety notes

Please read this manual carefully and completely before you use the device for the first time. The device may only be used by qualified personnel and repaired by PCE Instruments personnel. Damage or injuries caused by non-observance of the manual are excluded from our liability and not covered by our warranty.

- The device must only be used as described in this instruction manual. If used otherwise, this can cause dangerous situations for the user and damage to the meter.
- The instrument may only be used if the environmental conditions (temperature, relative humidity, ...) are within the ranges stated in the technical specifications. Do not expose the device to extreme temperatures, direct sunlight, extreme humidity or moisture.
- Do not expose the device to shocks or strong vibrations.
- The case should only be opened by qualified PCE Instruments personnel.
- Never use the instrument when your hands are wet.
- You must not make any technical changes to the device.
- The appliance should only be cleaned with a damp cloth. Use only pH-neutral cleaner, no abrasives or solvents.
- The device must only be used with accessories from PCE Instruments or equivalent.
- Before each use, inspect the case for visible damage. If any damage is visible, do not use the device.
- Do not use the instrument in explosive atmospheres.
- The measurement range as stated in the specifications must not be exceeded under any circumstances.
- Non-observance of the safety notes can cause damage to the device and injuries to the user.

We do not assume liability for printing errors or any other mistakes in this manual.

We expressly point to our general guarantee terms which can be found in our general terms of business.

If you have any questions please contact PCE Instruments. The contact details can be found at the end of this manual.

## 2 System description

### 2.1 Main unit

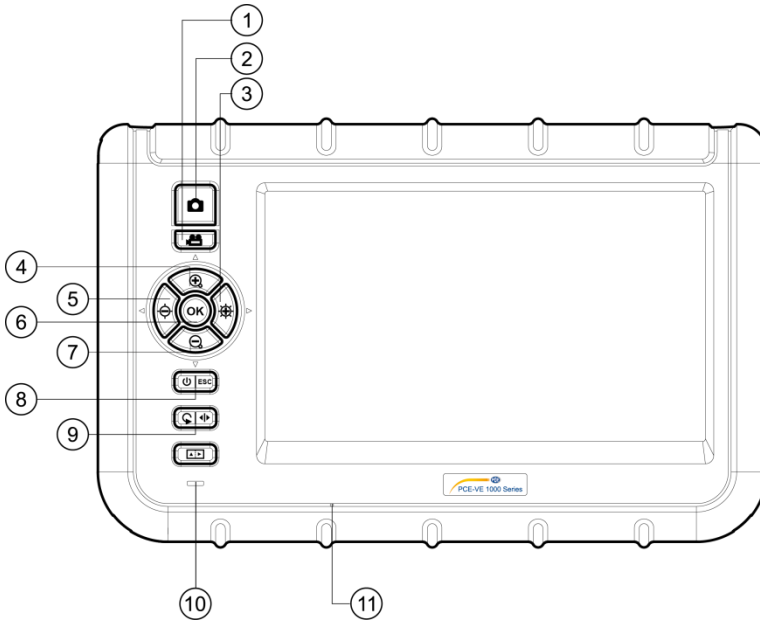

- 1 Record
- 2 Snap
- 3 Right / brighten
- 4 Up / zoom in
- 5 Left / dim
- 6 OK / Menu
- 7 Down / zoom out
- 8 Power / ESC
- 9 Rotate / mirror
- 10 Power indicator
- 11 Integrated microphone

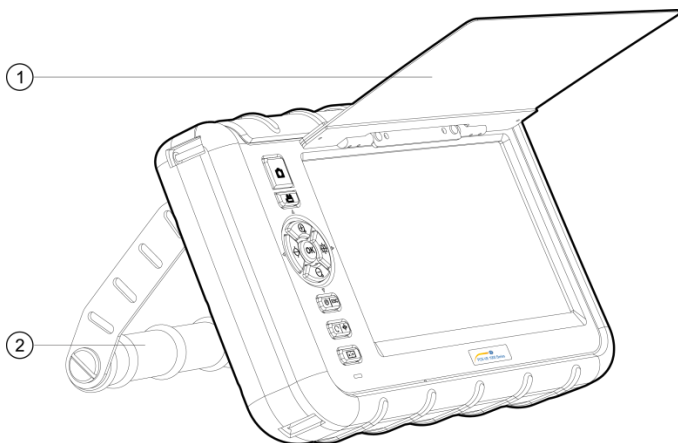

- 1 Sun visor
- 2 Stand

## 2.2 Connectors

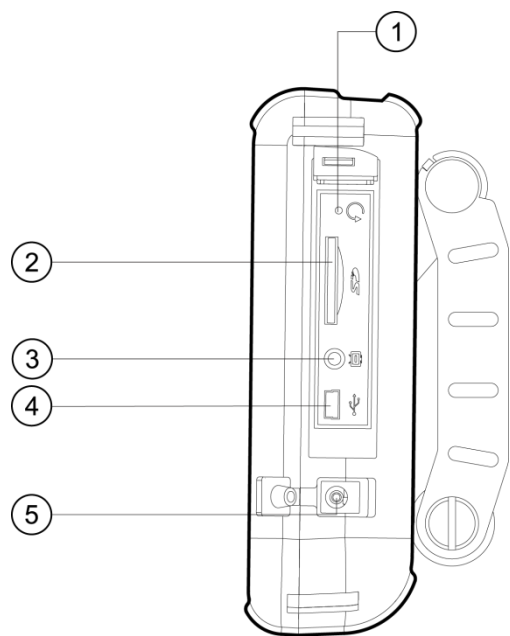

- 1 Reset
- 2 SD card slot
- 3 AV out
- 4 USB interface
- 5 DC in

### 2.3 Back

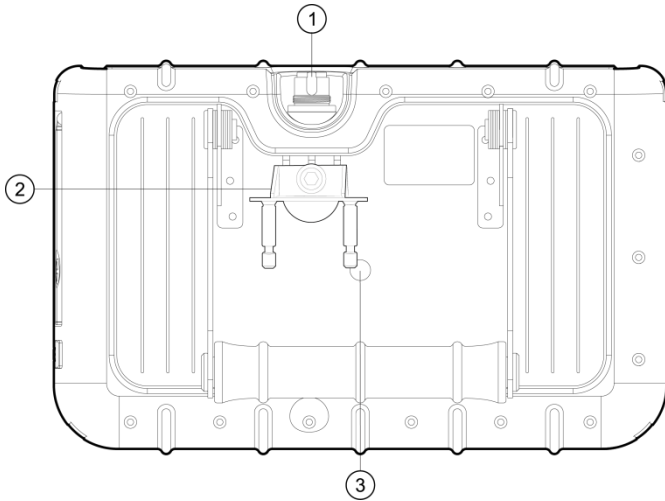

- 1 Insert tube connector
- 2 PRM280 mount
- 3 Tripod thread

### 2.4 Display



- 1 Date
- 2 Time
- 3 Repeat recording indicator
- 4 Brightness indicator
- 5 SD card status
- 6 Battery indicator

## 2.5 Display with included accessories

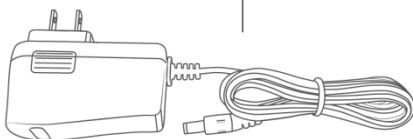
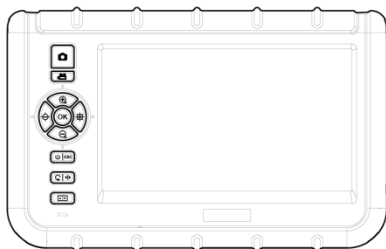
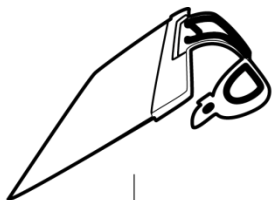

### 3 Preparations

1. Before the first operation of the borescope the battery has to be charged completely. This can be done by connecting the device to the power.
2. Take a borescope cable if available.
3. Connect the borescope cable to the main unit. Make sure that the cable is inserted correctly and tighten the sealing nut.
4. Switch on the device by pressing and holding the power button for about three seconds.
5. Insert the SD card. Open the corresponding lid on the side and insert the card.

### 4 Make recordings

#### 4.1 Record images

1. Move the camera head to the desired area of inspection.
2. Press the Snap button in order to save the displayed image.

#### 4.2 Record videos

To save a video to the SD card, the camera head has to be moved to the inspection area as described above. After this, press the Record button to start recording. If the Record button is pressed once again, the recording will end and the video is automatically stored to the SD card. The name of the file will be displayed in the left information field underneath the time indication after the recording has been stopped. Simultaneously with the video recording, an audio file will be recorded which allows the user to leave comments. Please note that it is not possible to zoom, rotate or reflect the image during video recordings.

### 5 SD card

The borescope uses SD cards to store images. It is possible to use SD cards with different capacities. Here you can store both images and videos. The amount of images and duration of the videos that can be stored vary with the different sizes of the SD cards. The approximate values can be seen in the chart below:

SD card capacity	4 GB	8 GB	16 GB	32 GB
Amount of images	<31000	<62000	<124000	<240500
Duration of videos	<130 min	<160 min	<530 min	<1000 min

### 6 Functions

#### 6.1 Setting the brightness

To adjust the brightness of the live images you can use the corresponding buttons. The left function key is used to dim the light. The right one is used to brighten up the light. Ten brightness levels are available where five of them are normal brightness levels and the other ones are with higher exposure time. These are advantageous when the camera head is moved in dark environments.





## 6.2 Zoom





During the inspection of live images, digital zoom can be used. This can be done by pressing the Zoom-In and Zoom-Out buttons. If the "+"-button is pressed the image is enlarged. Pressing the "-"-button will zoom out again. The zoom ratio is scaled linearly starting from 1.0 x up to 5.0 x. Due to the fact that it is a digital zoom, it may occur that the quality of the image suffers when zooming in.

## 6.3 Rotating and reflecting the image

From time to time it is useful and or even necessary to rotate the image on the display without moving the camera head. This can have multiple reasons.

1. Rotate image:  
To rotate the image in steps of 90 ° the  button must be pressed.
2. Reflect image: The image is reflected if the  button is pressed for more than three seconds. On the left-hand side of the display,  will be shown. If the non-reflected image is displayed, the same procedure must be repeated.





## 6.4 Pre-timed video recordings

The borescope offers the opportunity to record pre-timed sequences which will be repeated after the time has run off. These sequences are recorded until the  button is pressed again. The duration of the video can be 5, 10, 20 and 30 minutes. If the function is not activated, the recording will automatically be stopped after 30 minutes. To enable the single sequences, enter the main menu by pressing the **OK** button. After this, the  and  buttons must be used to get to the submenu "REPEAT RECORDING". Confirm by pressing **OK** once again. Now choose your desired duration by using the  and  buttons and confirm your choice by pressing **OK**. You can choose between 5, 10, 20, 30 minutes and "OFF".

## 6.5 Playback function

To review the last recorded files on the LCD, the **ESC** button must be pressed after the recording. The images will automatically be displayed after that. If a video has just been recorded, the **OK** button must be pressed additionally to play the video.

You can scroll through the files:

-  switch to the previous file
-  switch to the next file
-  go 10 files back
-  go 10 files forward

When reviewing images you can also zoom to a desired area within the picture. You have the opportunity to zoom in in three steps. To do so, the image must be on the display. Then press **OK**. After this, a small window will appear in the bottom right corner of the LCD with a green frame, which shows the area which is enlarged. Pressing **OK** again enlarges the section once again. If the maximum enlargement of the section is reached and **OK** is pressed once again, the device will switch to playback mode again. The specific section which is framed green can also be moved within the image:

-  left
-  right
-  up
-  down

A video file can be played (without the audio file) by pressing **OK** if the video is selected.

In the playback function, unwanted files can also be deleted. In order to do so, the files have to be selected first. When reviewing them on the LCD, press **[DEL]**. The dialogue "DELETE FILE ?" will be shown with the answers "YES" and "NO". By using **[+]** and **[-]**, you can make your choice (highlighted in green) which can be confirmed by pressing **OK**.

To show thumbnails of saved images, press the **[TH]** button. The function keys help you to navigate through the thumbnails. On each page, nine files will be shown in a 3x3 grid. This makes it possible to delete more than one file at a time. This can be done by following these steps:

1. Move the orange frame to the unwanted file. Use the arrow keys in the corresponding direction.
2. Press **[X]** to mark the chosen file. It will then be marked with an orange "X".
3. When all unwanted files are marked, press the **[DEL]** button to start the deletion process. The display will show "DELETE FILE ?" and give you the options "YES" and "NO". Use **[+]** and **[-]** to make your choice and confirm by pressing **OK**. The data will then be deleted.

## 6.6 Functions for video recording

1. Pause: **OK**
2. Change the speed of the playback: **[+]** or **[-]**
3. Fast forward / rewind: **[>]** or **[<]**

## 7 Settings



### 7.1 General settings

1. Open main menu: When reviewing files, pressing **OK** opens the main menu
2. Navigating through the main menu: **[+]** and **[-]**
3. Open a submenu: **OK** or **[>]**
4. Return to the higher menu level: **ESC**

### 7.2 SD card





1. Check the state of the SD card: Open the main menu and then open the submenu "SD CARD STATUS".
2. Format SD card: Open the main menu and open the submenu "SD CARD STATUS". Choose "FORMAT SD CARD". Use **[+]** and **[>]** to choose "YES" and confirm your choice.
3. Delete all files on the SD card: Open the main menu and then open the submenu "SD CARD STATUS". Choose "DELETE ALL FILES", go to "YES" and confirm your choice.

### 7.3 Language





Open the main menu and navigate to the submenu "LANGUAGE". Use  and  to navigate, choose your language and confirm your choice.

### 7.4 Date and time



#### System time

Open the main menu and navigate to the submenu "DATE / TIME". Use the  and  buttons to switch between the setting fields and  and  to set the values correctly. Confirm your choice by pressing **OK**.



#### Time format

To set the correct time format enter the main menu first and then enter the submenu "DATE / TIME". You can go to the time format setting by using  and .  and  help you to choose the correct time format (YY/MM/DD, MM/DD/, DD/MM/YY). Confirm by pressing **OK**.

#### Time and date stamp



The borescope gives you the opportunity to mark your files with a time and date stamp. To activate this function, enter the main menu and then enter the submenu "DATE / TIME". By using  and  you can get to the function "TIMESTAMP". Choose "YES" or "NO" and confirm with **OK**.

### 7.5 Automatic shutdown

In order to reduce the battery consumption, the borescope has an automatic shutdown function that can be activated. To do so, enter the main menu and the submenu "AUTO POWER OFF". The buttons  and  can be used to navigate through the different time settings. You can choose between 5, 10, 20 and 30 minutes or deactivate this function by selecting "OFF". Confirm your choice by pressing **OK**. If the device has turned itself off, it does not enter a sleep mode but switches off completely and must be restarted completely.

## 8 Connectors



### 8.1 USB

The USB interface is commonly used to connect the borescope to a computer. It supports two different modes. On the one hand it supports the data transmission and on the other hand it can help to display the live pictures on a computer. When the borescope is connected to a computer, it displays "READER" and "CAMERA". Depending on what mode needs to be set you can use the  and  buttons to make your choice. Confirm with **OK**.

You can also get there by entering the main menu and choosing the submenu "USB". If the device is connected via USB, a USB icon will appear in the left information box. If the reader function is chosen there will be a stylized SD card symbol on the display. The reader mode can be stopped by pressing **ESC**.

## 8.2 AV output

The AV output serves to transfer files to a television in standard definition. HD is not supported.

1. Connect the device to a TV using the AV cable.
2. Use  and  to switch between "NTSC" and "PAL" (depending on the TV).
3. Confirm with **OK**.
4. You can leave the mode by pressing **ESC**.



## 9 Maintenance

### 9.1 Replacing the borescope cable

If a different cable needs to be installed to the borescope you can proceed as follows:

1. Switch off the device.
2. Loosen the cable from the device and pull it out carefully.
3. Insert the different borescope cable. Note that the pins have to be inserted correctly.
4. Tighten the sealing nut.

### 9.2 Firmware update

1. Switch off the device. Press and hold **ESC** and  simultaneously to enter factory mode.
2. After this, the firmware version will be displayed.
3. Copy the file of the new firmware to an SD card.
4. Insert that SD card into your borescope.
5. Press  and **ESC** to turn on the device.
6. The update will be made automatically.
7. The instrument will switch off after the update.

## 10 Borescope cables

You have the opportunity to connect different cables to the borescope.

PCE-VE 1yyz-ab	yy	z	a	b	Note
<b>Cable length</b>					
1 m	01				
2 m	02				Only 5.5 mm cable / head selectable
3 m	03				Only 6 mm cable / head selectable
10 m	10				Only 5.5 mm cable / head selectable
22 m	22				Only 28 mm cable / head selectable (code 0)
<b>Ø cable head</b>					
3.9 mm		3			2 cables included: 0 ° and 90 °
4.9 mm		4			With front and lateral camera
5.5 mm		5			With front camera
6 mm		6			2-way
28 mm		0			Always with 22 m cable
<b>Resolution</b>					
320 x 240					
640 x 480			HR		
<b>Type of cable</b>					
Flexible				-F	n. a. for 22 m cable Only added for flexible cables
Semi-flexible (gooseneck)					

### Special editions:

**PCE-VE 1014N-F:** 1.5 m cable length, 4.5 mm Ø cable head, 2-way, large display

**PCE-VE 1034N-F:** 3 m cable length, 4.5 mm Ø cable head, 2-way, large display

### 10.1 Borescope cable with a swivelling camera

1. Camera tube
2. Lens
3. Bending neck
4. Operating element
5. Rotary knob
6. Connection cable
7. Connector plug
8. Locking lever

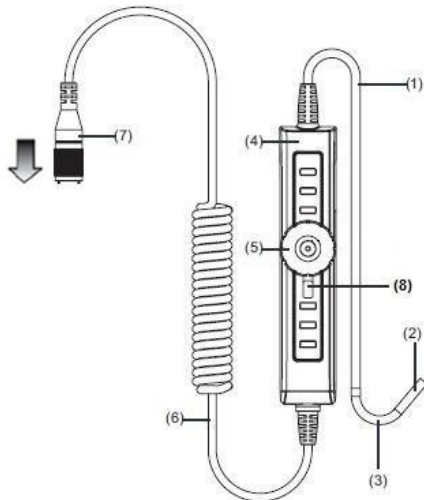

## Preparations

1. Insert the end of the borescope cable into the connection socket. Use the white dot on the borescope cable for your orientation, to know which way round it has to be inserted into the socket and tighten the sealing nut.
2. Turn on the borescope and place the camera head in the desired inspection area.

## Operation

1. Using the rotary knob, you can control the wire-draw mechanism. This moves the camera head. By turning the rotary knob clockwise the camera head will be bent to the right side. Turning the rotary knob counter-clockwise will turn the camera head to the left side.

**ATTENTION:** Overwinding the rotary knob will damage the wire-draw mechanism of the borescope cable.

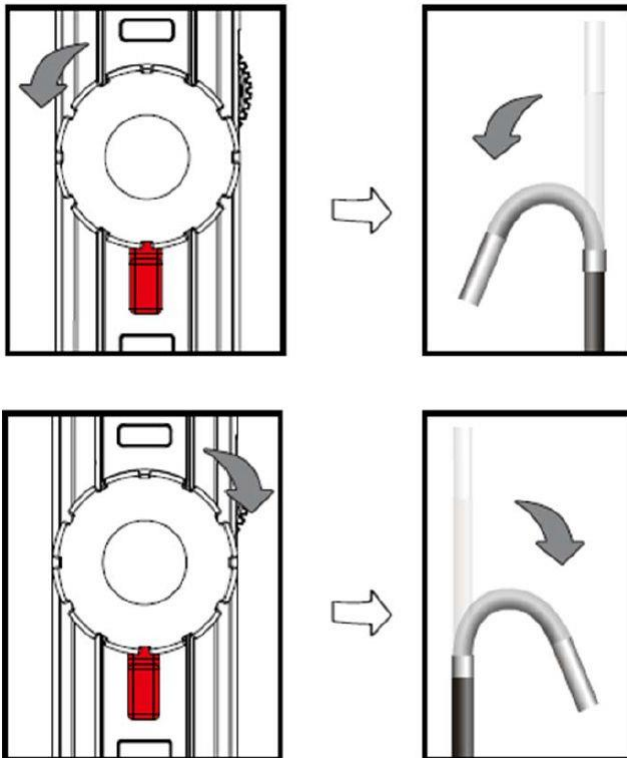

- The locking lever can be turned to the left side. By doing so, the camera head will remain in the position that has been selected before. It can be loosened by turning the locking lever to the neutral position in the middle. The camera head can then be moved again.

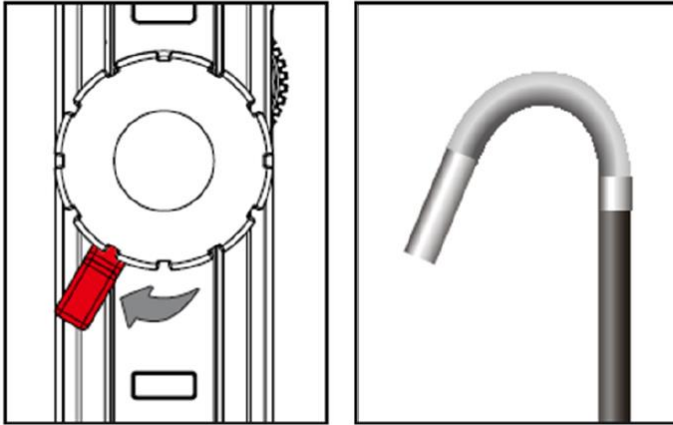

## 10.2 HR borescope cable

In addition to the general safety notes of the device, please mind the following safety notes to prevent damage and injuries when using the HR camera cable.

- To avoid dangerous situations, make sure that the probe does not get in touch with inflammable liquids or gases.
  - The HR cable includes various small cables which control the optics and electronics of the camera tip. To ensure high reliability, do not bend the cable to an angle of more than 90 ° and store the cable as little bent as possible.
  - Do not disassemble the device as this can cause damage and electric shocks.
  - Do not expose the device to direct sunlight and store it in a cool, dry, sufficiently ventilated place.
  - To protect the camera module, make sure the protection ring is on the camera head as long as no accessories are in use.
- Do not apply force to the end of the cable and do not bend it. This can deteriorate your vision and even damage the probe.

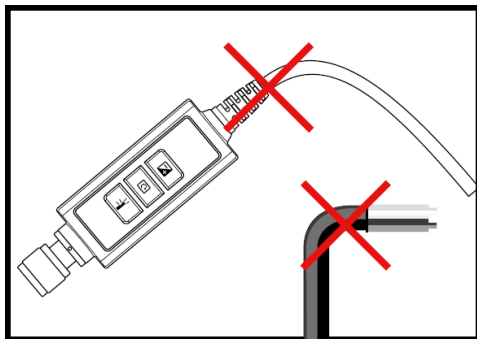

- When you roll up the cable, the inner diameter must be at least 15 cm.

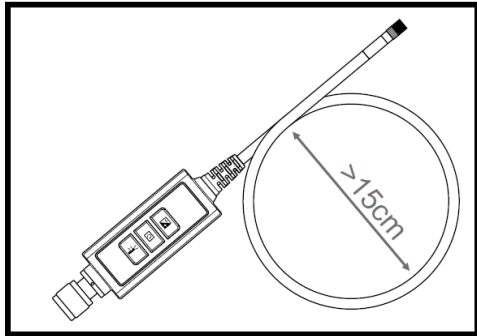

- Put the protection ring back on and tighten it when not using the device for a longer period of time.

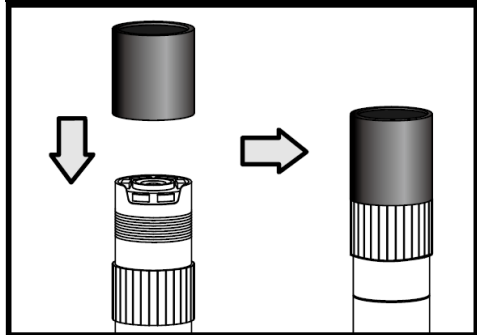

- Do not crash the probe head.

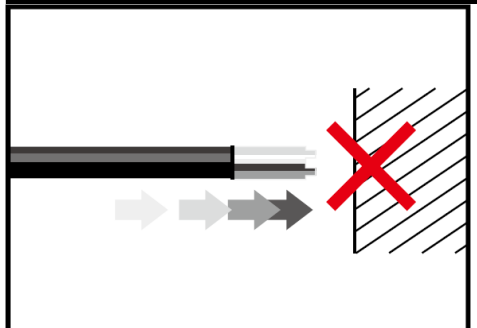

- Make sure that the camera does not get in contact with the following liquids:  
lead-free petrol, diesel oil,  
machine oil, brake fluid and  
transmission oil.

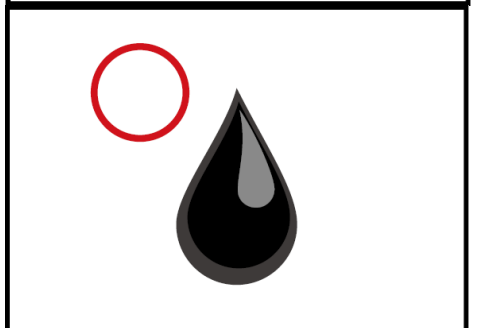



- Do not screw the accessories on too tightly. Only screw it slightly until it is fixed.

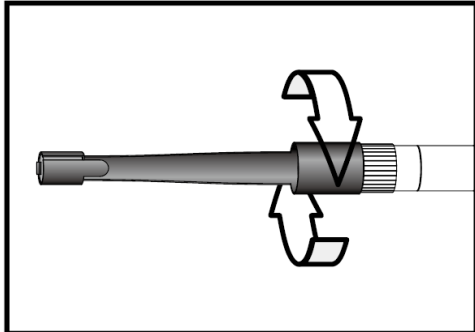

- To clean the camera head, use the cleaning liquid and the swabs provided in the cleaning kit.

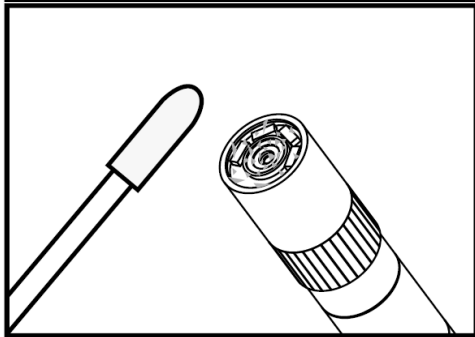

### Technical specifications

Length of camera head	20 mm
Diameter with protection ring	6 mm
Depth of field	10 ... 60 mm
Field of view	60.7 °
Protection class	IP67

## System description

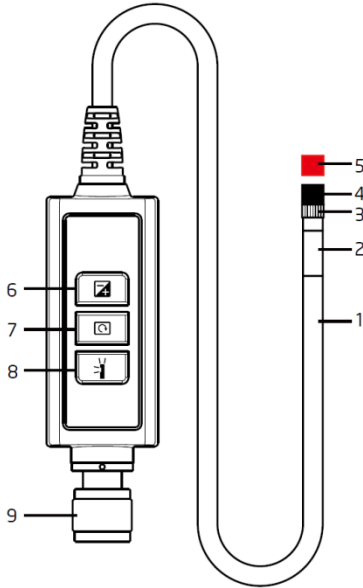

1. **Probe:** to guide the camera
2. **Camera head:** for illumination and capturing
3. **Assembly ring:** to attach accessories
4. **Protection ring:** to protect the thread
5. **Red cap:** protects the camera when not in use
6. **Boost key:** for better illumination in dark environments
7. **Rotation key:** Press once to turn the display counter-clockwise by 90 °. The red LED will light up. The LED will stop glowing when the original position has been reached.
8. **Light key:** This key activates a mirror which enables particle-free vision.
9. **Connector**

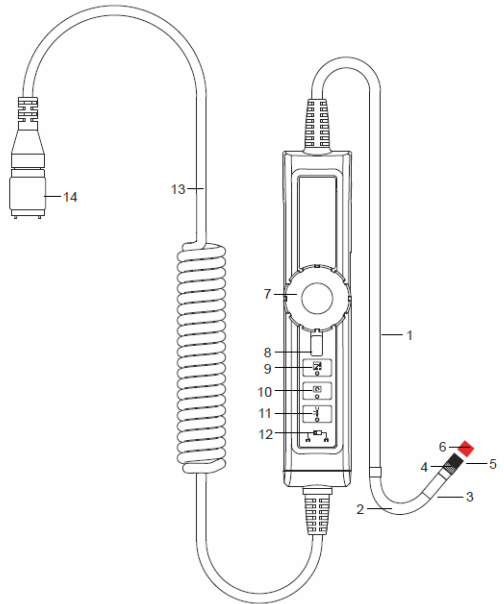

1. **Probe:** to guide the camera
2. **Bending neck**
3. **Camera head:** for illumination and capturing
4. **Assembly ring:** to attach accessories
5. **Protection ring:** to protect the thread
6. **Red cap:** protects the camera when not in use
7. **Rotary knob**
8. **Locking lever**
9. **Boost key:** for better illumination in dark environments
10. **Rotation key:** Press once to turn the display counter-clockwise by 90 °. The red LED will light up. The LED will stop glowing when the original position has been reached.
11. **Light key:** This key activates a mirror which enables particle-free vision.
12. **Lock:** To lock button functions
13. **Connecting Cable**
14. **Connector**

## Getting started

### Connection

- Step 1: Connect the main unit with the connector and fix it with the screw mechanism.  
Step 2: Switch on the system. You should now see a picture in the display.

### Attachment of the accessories

#### Mirror

- Step 1: Unscrew the thread protection ring.  
Step 2: Screw the assembly ring down to the bottom.  
Step 3: Screw the mirror attachment onto the thread until the thread is completely covered.

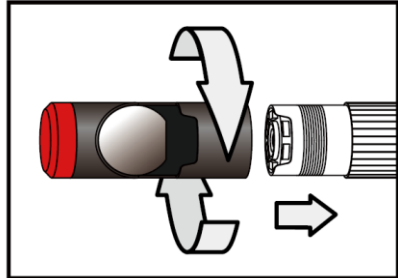
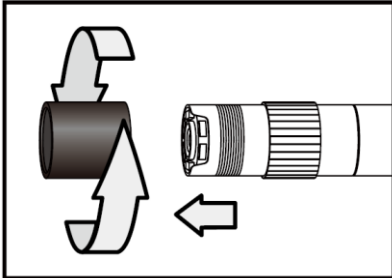

Step 4: Align the lateral LED opening of the mirror attachment in a way that the LEDs are uncovered.

Step 5: Turn the assembly ring upwards in order to fix the mirror attachment.

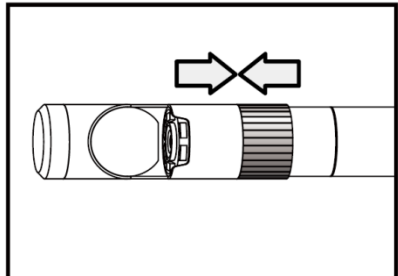
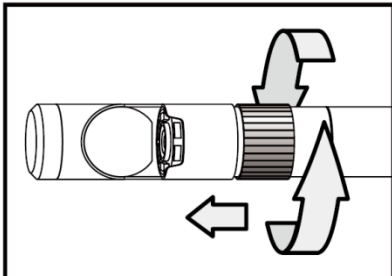

Step 6: Press the light key to activate the lateral light.

Step 7: Adjust the light intensity as required to ensure ideal vision to the side.

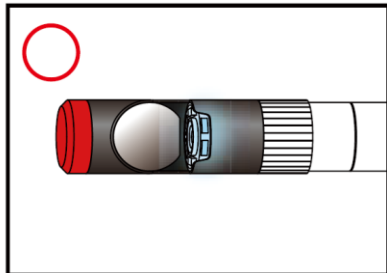
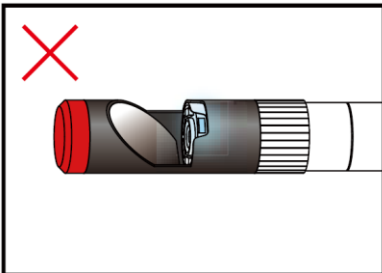

(Steps 4-5 must be repeated until the right position is reached)

### Magnetic hook

Step 1: Turn the assembly ring down to the bottom.

Step 2: Screw the magnetic hook on until it snaps in.

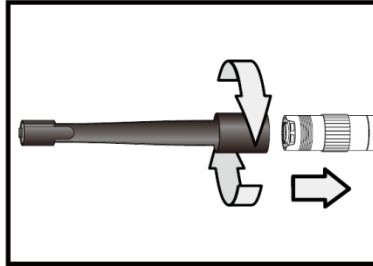
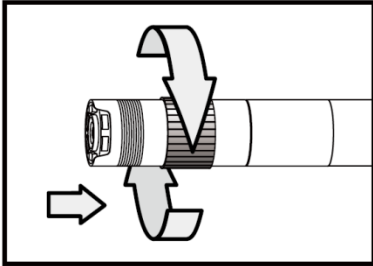

### Climbing ball

Step 1: Remove the assembly ring.

Step 2: Screw the climbing ball on until it snaps in.

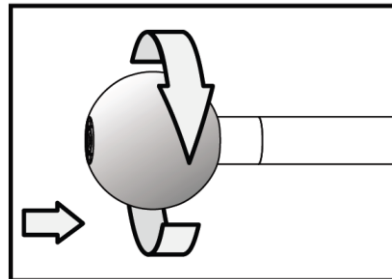
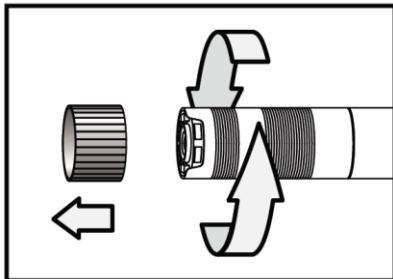

Please note that the magnetic hook and the climbing ball can only be attached to borescope cables with a diameter of 5.5 mm.

### Operation

#### Boost key

Use this key in a dark environment. The red LED indicates that the Boost function has been activated. The image will be lightened up.

Note: Hold the probe steady.



Before "boosting"



After "boosting"

**Rotation key** 

You can use this key to turn the image by 90 ° four times, for instance, when trying to read an inscription completely.



**Light key** 

When using the mirror attachment, this key improves the vision which will not be impeded by particles, dust, etc.



Without "particle free" function



With "particle free" function

## 11 Contact

If you have any questions, suggestions or technical problems, please do not hesitate to contact us. You will find the relevant contact information at the end of this user manual.

## 12 Disposal

For the disposal of batteries in the EU, the 2006/66/EC directive of the European Parliament applies. Due to the contained pollutants, batteries must not be disposed of as household waste. They must be given to collection points designed for that purpose.

In order to comply with the EU directive 2012/19/EU we take our devices back. We either re-use them or give them to a recycling company which disposes of the devices in line with law.

For countries outside the EU, batteries and devices should be disposed of in accordance with your local waste regulations.

If you have any questions, please contact PCE Instruments.



# PCE Instruments contact information

## Germany

PCE Deutschland GmbH  
Im Langel 4  
D-59872 Meschede  
Deutschland  
Tel.: +49 (0) 2903 976 99 0  
Fax: +49 (0) 2903 976 99 29  
info@pce-instruments.com  
www.pce-instruments.com/deutsch

## France

PCE Instruments France EURL  
76, Rue de la Plaine des Bouchers  
67100 Strasbourg  
France  
Téléphone: +33 (0) 972 3537 17  
Numéro de fax: +33 (0) 972 3537 18  
info@pce-france.fr  
www.pce-instruments.com/french

## Spain

PCE Ibérica S.L.  
Calle Mayor, 53  
02500 Tobarra (Albacete)  
España  
Tel. : +34 967 543 548  
Fax: +34 967 543 542  
info@pce-iberica.es  
www.pce-instruments.com/espanol

## United States of America

PCE Americas Inc.  
711 Commerce Way suite 8  
Jupiter / Palm Beach  
33458 FL  
USA  
Tel: +1 (561) 320-9162  
Fax: +1 (561) 320-9176  
info@pce-americas.com  
www.pce-instruments.com/us

## United Kingdom

PCE Instruments UK Ltd  
Units 12/13 Southpoint Business Park  
Ensign Way, Southampton  
Hampshire  
United Kingdom, SO31 4RF  
Tel: +44 (0) 2380 98703 0  
Fax: +44 (0) 2380 98703 9  
info@industrial-needs.com  
www.pce-instruments.com/english

## Italy

PCE Italia s.r.l.  
Via Pesciatina 878 / B-Interno 6  
55010 LOC. GRAGNANO  
CAPANNORI (LUCCA)  
Italia  
Telefono: +39 0583 975 114  
Fax: +39 0583 974 824  
info@pce-italia.it  
www.pce-instruments.com/italiano

## The Netherlands

PCE Brookhuis B.V.  
Institutenweg 15  
7521 PH Enschede  
Nederland  
Telefoon: +31 (0) 900 1200 003  
Fax: +31 53 430 36 46  
info@pcebenelux.nl  
www.pce-instruments.com/dutch

## Chile

PCE Instruments Chile SPA  
RUT 76.423.459-6  
Badajoz 100 oficina 1010 Las Condes  
Santiago de Chile / Chile  
Tel. : +56 2 24053238  
Fax: +56 2 2873 3777  
info@pce-instruments.cl  
www.pce-instruments.com/chile

## Hong Kong

PCE Instruments HK Ltd.  
Unit J, 21/F., COS Centre  
56 Tsun Yip Street  
Kwun Tong  
Kowloon, Hong Kong  
Tel: +852-301-84912  
jyi@pce-instruments.com  
www.pce-instruments.cn

## China

PCE (Beijing) Technology Co.,Ltd  
1519 Room, 6 Building  
Men Tou Gou Xin Cheng,  
Men Tou Gou District  
102300 Beijing  
China  
Tel: +86 (10) 8893 9660  
info@pce-instruments.cn  
www.pce-instruments.cn

## Turkey

PCE Teknik Cihazları Ltd.Şti.  
Halkalı Merkez Mah.  
Pehlivan Sok. No.6/C  
34303 Küçükçekmece - İstanbul  
Türkiye  
Tel: 0212 471 11 47  
Faks: 0212 705 53 93  
info@pce- cihazlari.com.tr  
www.pce-instruments.com/turkish