

PCE Americas Inc.
711 Commerce Way
Suite 8
Jupiter
FL-33458
USA
From outside US: +1
Tel: (561) 320-9162
Fax: (561) 320-9176
info@pce-americas.com

PCE Instruments UK Ltd.
Units 12/13
Southpoint Business Park
Ensign way
Hampshire / Southampton
United Kingdom, SO31 4RF
From outside UK: +44
Tel: (0) 2380 98703 0
Fax: (0) 2380 98703 9
info@pce-instruments.com

www.pce-instruments.com/english
www.pce-instruments.com

Manual

Industrial Borescope PCE-IVE 320 / PCE-IVE 330



Version 1.1
Date of creation: 06.09.2016
Date of last change: 25.10.2017

Contents

1	Introduction	3
2	Safety notes	3
3	Specifications	3
4	System Description	4
4.1	Camera Head	4
4.2	Telescopic stick	4
4.3	Rotary Coupling	4
4.4	Digital monitor	5
4.5	Operating Element	5
4.6	Handle	6
4.7	Guide roller with mounting fixture	7
4.8	Mounting	7
5	Instructions	8
6	Screen symbols	8
6.1	Standby mode	8
6.2	Recording mode	8
7	DVR setting	9
7.1	Image setting	9
7.1.1	Image quality adjustment	9
7.1.2	Frame rate setting	10
7.1.3	Resolution setting	10
7.2	REC setting	10
7.2.1	Overwrite	11
7.2.2	Rec. duration	11
7.3	Playback and deletion of a video file	11
7.4	System settings	12
7.4.1	Language settings	12
7.4.2	Time and date setting	13
7.4.3	Formatting	13
7.4.4	SD card capacity check	14
7.4.5	Date format	14
7.4.6	Time display on the screen	15
8	FAQ	15
9	Disposal	16
10	Contact	16
10.1	PCE Instruments UK	16
10.2	PCE Americas	16

1 Introduction

Thank you for purchasing a telescopic camera PCE-IVE 320 / PCE-IVE 330 from PCE Instruments. The telescopic camera allows the user to get new insights of the places that are difficult to access or are located high. Due to the telescopic stick of up to 2.3 m, the camera is ideal for maintenance and inspections. With the help of the device, you can detect the problem spots. Use in the dark is also possible due to the LEDs that are attached to the camera head. A very useful feature of the telescopic camera is that you can make videos and take pictures using the digital recorder. Thus, they can be used for the analysis later.

2 Safety notes

Please read this manual carefully and completely before you use the device for the first time. The device may only be used by qualified personnel and repaired by PCE Instruments personnel. There is no warranty of damages or injuries caused by non-observance of the manual.

- Do not drop the device or exert any strong physical pressure on this unit.
- Attach the camera tightly to the device if you use it underwater.
- Turn the display carefully. The display can be moved from left to right at less than 30° and up at less than 90°.
- Insert the SD card the right way round to avoid damage to the device.
- When you insert the SD card for the first time, let the device format the card.
- Do not remove the SD card when the unit is not in operation.
- Use only the supplied charging adapter.

This user's handbook is published from PCE Instruments without any guarantee.

We expressly point to our general guarantee terms; they can be found in our general terms of business. If you have any questions, please, contact PCE Instruments.

3 Specifications

Camera		
Camera head	¼ CMOS	
Pixels	0.3 megapixels	
LED	12 white LEDs	
Camera length	320 mm	
Camera diameter	23 mm	
Monitor		
LCD screen	PCE-IVE 320: 5.0-inch LCD	PCE-IVE 330: 8.0-inch LCD
Resolution	800 x 480	
Monitor size	130 x 80 x 10 mm	
Telescopic stick		
Max. length	2.3 m	
Min. length	0.9 m	
Battery		
Battery capacity	1500 mAh	
Output voltage	DC 12 V	
Charging adapter		
Input voltage	AC 100 ... 240 V 50/60 Hz	
Output voltage	DC 12 V 500 mA	
DVR		
PAL output	704 x 576 (PAL)	
Video format	MPEG-4	
Recording format	ASF	
SD card	2 ... 32 GB	
Complete set		
Length	Max. length 3 m	
Voltage supply	DC 12 V	
Operating / storage temperature	-20 °C ... +50 °C	

4 System Description

4.1 Camera Head

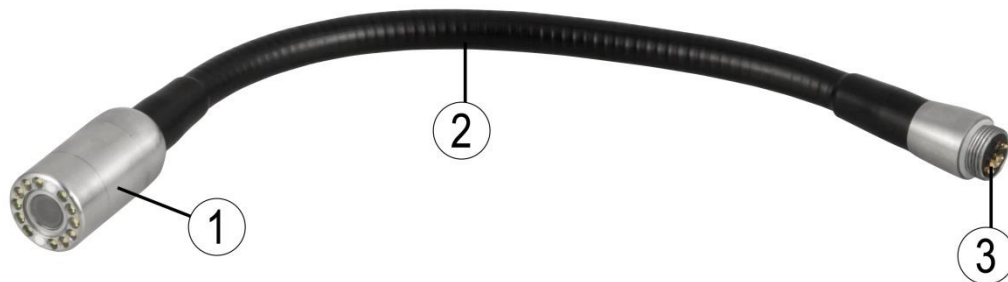

1. Camera head
2. Flexible connection
3. Connection with gilded pins

4.2 Telescopic stick

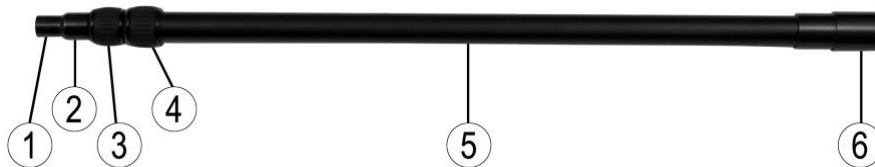

1. Connection to the camera
2. Telescopic shaft
3. Telescopic shaft
4. Telescopic shaft
5. Telescopic shaft
6. Control connection

4.3 Rotary Coupling

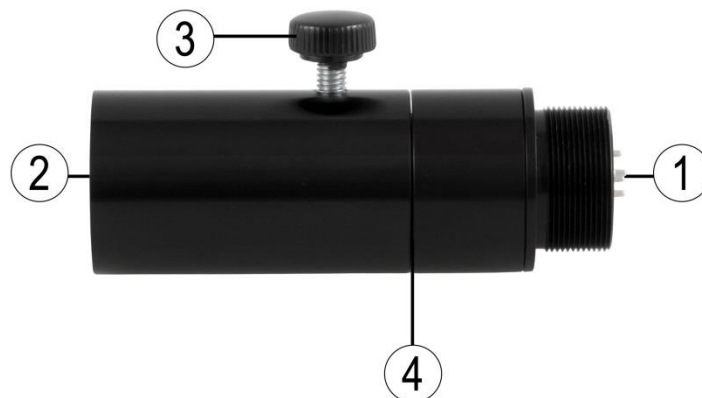

1. Connection to the telescopic stick
2. Connection to the operating element
3. Rotary adjustment screw
4. Allen screw

4.4 Digital monitor

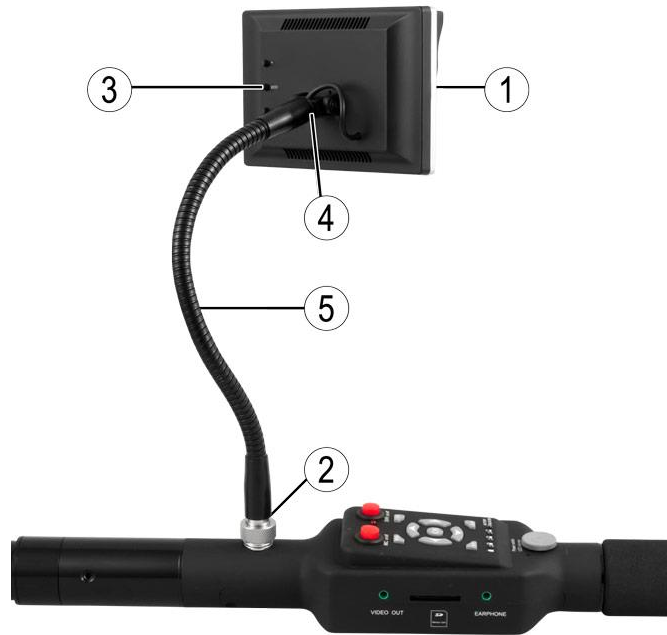

1. TFT screen
2. Monitor connection with knurled nut
3. Buttons
4. Inclinable monitor bracket
5. Gooseneck

4.5 Operating Element

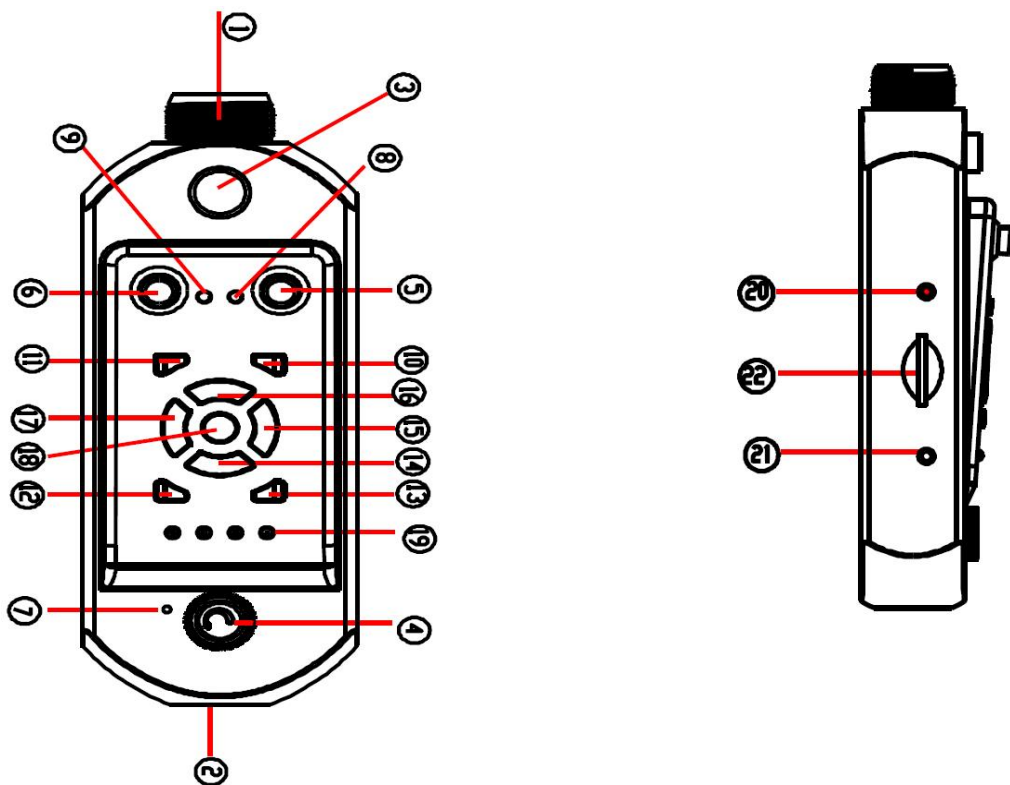

No.	Button / designation	Function
1	Connector	Connection to the camera
2	Connector	Connection to the handle / battery
3	Plug	Connection to the monitor
4	Rotating knob	On / Off / dim LEDs
5	DVR button	Digital video recorder on / off
6	MIC button	Microphone on / off
7	Microphone	Microphone connection
8	DVR control light	Video recorder in operation
9	MIC control light	Microphone in operation
10	ESC button	Go back / play
11	MENU button	Main menu
12	P/P button	Photograph / Play / Pause / Delete a file
13	STOP button	Stop
14	▲ button	Up / increase volume
15	▼ button	Down / reduce volume
16	◀ button	To the left / rewind
17	▶ button	To the right / fast forward
18	OK button	Confirm entry
19	Battery indicator	Shows battery level
20	Video port	Connection to another monitor
21	SD card slot	Interface for the SD card
22	Headphone jack	Headphone connector

4.6 Handle



1. Connection
2. 12 V charging connector

4.7 Guide roller with mounting fixture

The guide roller allows to move the device in areas which are hard to access and avoids damage like scratches.



4.8 Mounting

1. Take off the protecting cases of the components.
2. Attach the guide roller to the telescopic stick.



3. Connect the camera head to the connecting piece of the telescopic stick.



4. Connect the rotary coupling to the other connecting piece of the telescopic stick.



5. Connect the operating element to the connecting piece of the rotary coupling.



6. Connect the handle to the connecting piece of the operating element.



7. Connect the monitor to the operating element and tighten the nut firmly.



5 Instructions

1. Turn the knob clockwise to turn on the device, to activate the LEDs and to adjust the brightness.
2. Align the screen.
3. Extend the second and third telescopic shaft. Do not forget to screw the connecting parts firmly, otherwise the shaft retracts. Retract the shaft when taking close-ups.
4. The flexible connection of the camera head can be bent to bring the camera into the correct position.
5. Use the rotary coupling to adjust the direction of the camera.
6. Note the battery level. The system turns off automatically when the battery level is too low.
7. Use the 12 V charging connection to recharge. Do not use the battery during the charging process.
8. If you do not need the video recorder, then switch it off to save battery power.
9. Insert the SD card correctly.
10. When you are in standby mode, press the P/P button to take a picture and the OK button to start recording.

6 Screen symbols

6.1 Standby mode

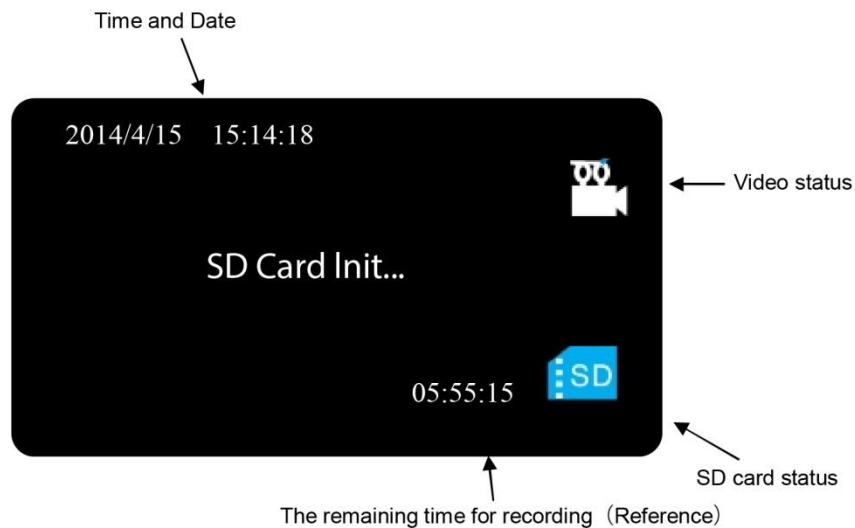

6.2 Recording mode

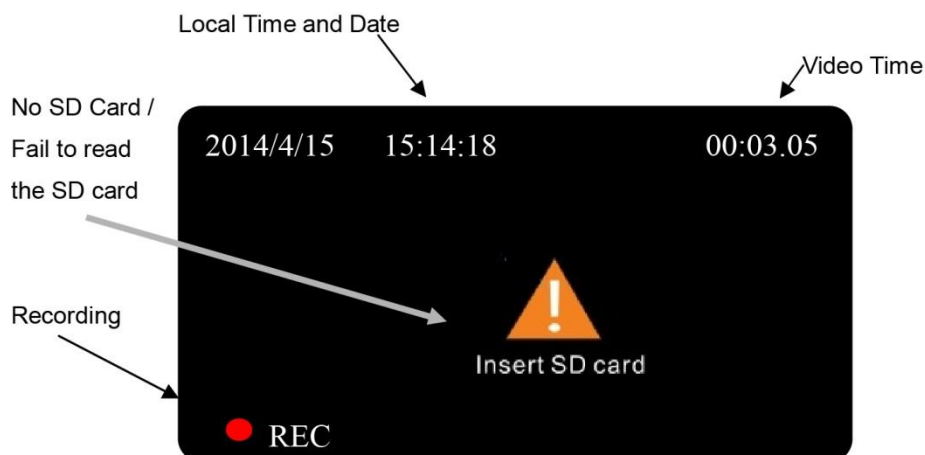

7 DVR setting

7.1 Image setting

7.1.1 Image quality adjustment

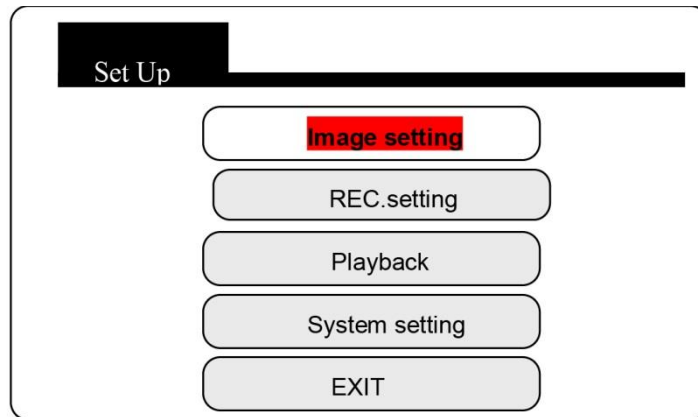

Press the "Menu" button to enter the main menu.



H = high quality
M = medium quality
L = low quality

7.1.2 Frame rate setting

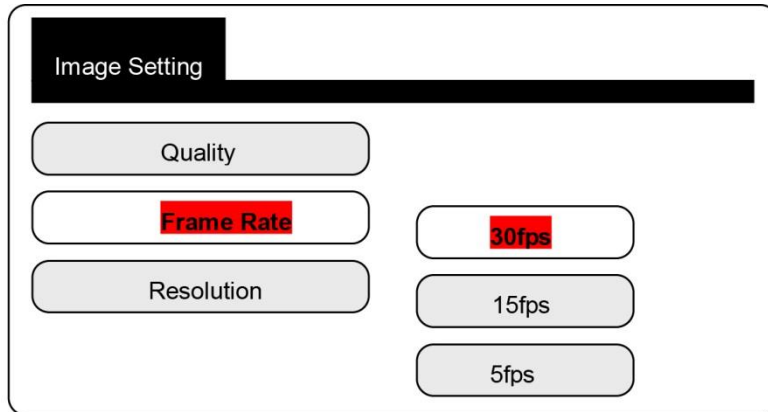

30 fps: liquid image
 15 fps: non-liquid image
 5 fps: irregular image

7.1.3 Resolution setting

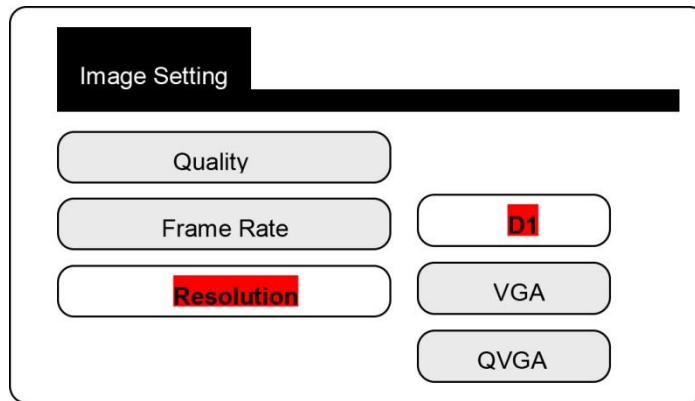

D1: 704 x 576
 VGA: 640 x 576
 QVGA: 320 x 288

7.2 REC setting

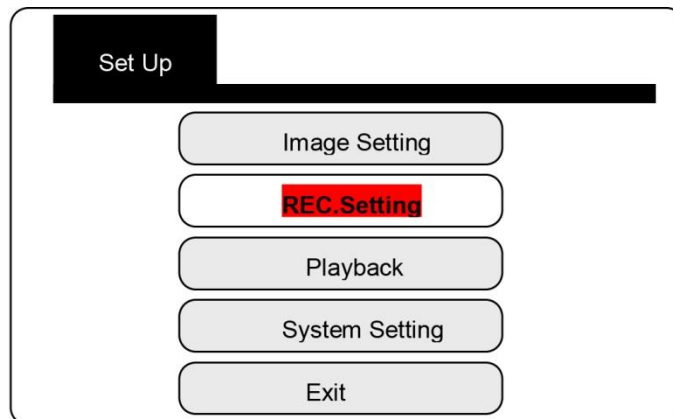

Press the "Menu" button to enter the main menu.

7.2.1 Overwrite

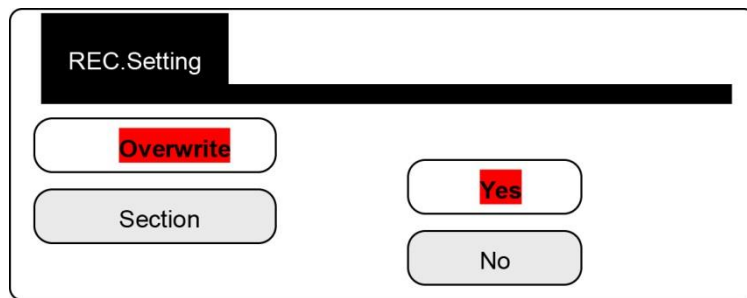

Note: if the SD card is full, the video recorder deletes the last 300 MB and then starts recording new files.

7.2.2 Rec. duration

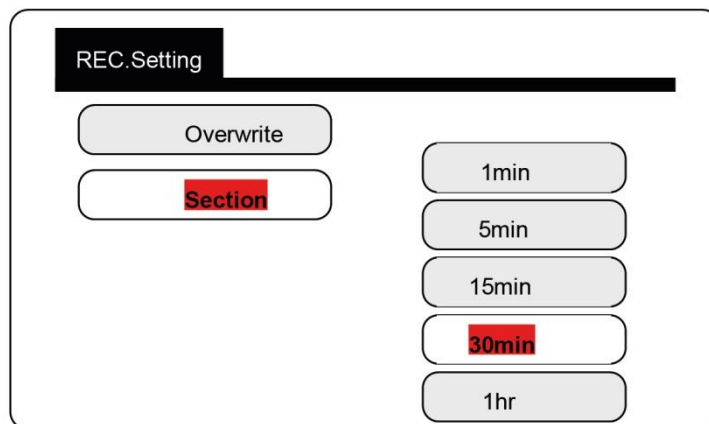

7.3 Playback and deletion of a video file

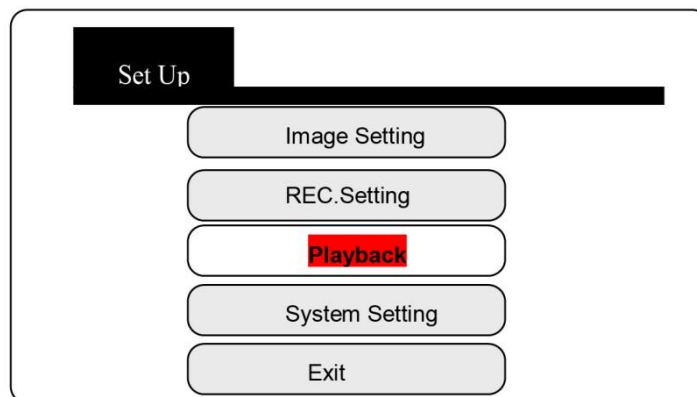

Press the “OK” button to open the list of video files.

	File Name	Date	Start Time
	ASF 00000001	2014/4/14	05 : 06 : 50
	ASF 00000002	2014/4/14	05 : 56 : 02
	ASF 00000003	2014/4/14	00 : 32 : 55
	ASF 00000004	2014/4/14	11 : 14 : 05

Page 01 / 14

Deletion:

1. Press ▲ / ▼ to select a file.
2. Press the P/P button to delete a file.

Playback:

1. Press ▲ / ▼ to select a file and then press the OK button.
2. Press the P/P button to play the file.

Video fast forward / rewind: (2, 4, 6, 16 x playback to select)

When you play the video, press the ► key to fast forward and the ◀ key to rewind.

Set the volume:

When the video is playing, press the ▲ key to increase the volume or the ▼ key to decrease the volume. The highest volume level is 8. The lowest volume level is 0.

Pause:

When the video is playing, press the P / P button to pause the video. Press again to play the video again.

Stop:

When the video is playing, press the STOP button to stop the playback.

Exit playback mode:

Press the ESC button to return to the list of video files.

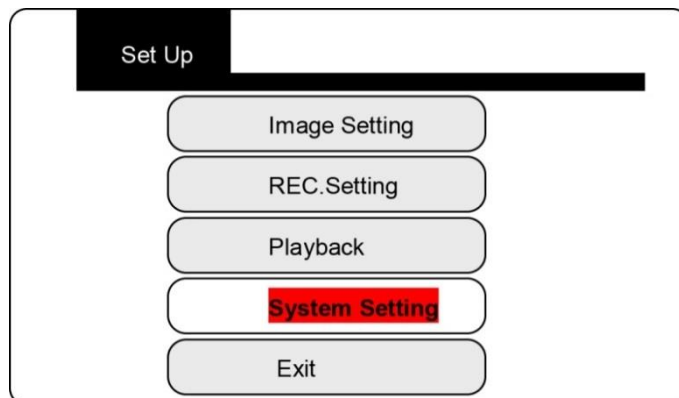
7.4 System settings

Press the OK button to enter the settings.

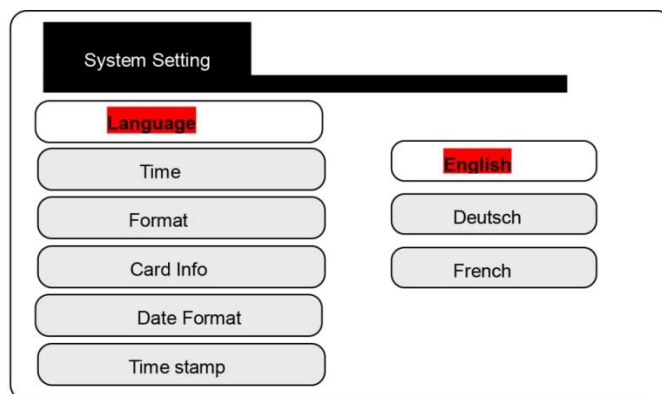
7.4.1 Language settings

Select the appropriate language.

7.4.2 Time and date setting

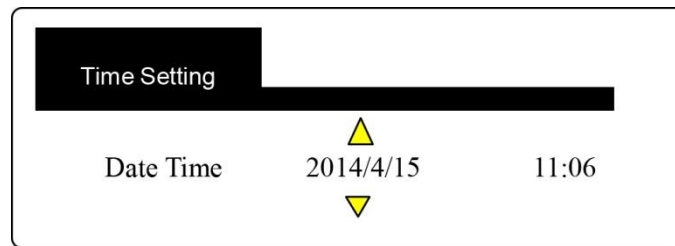
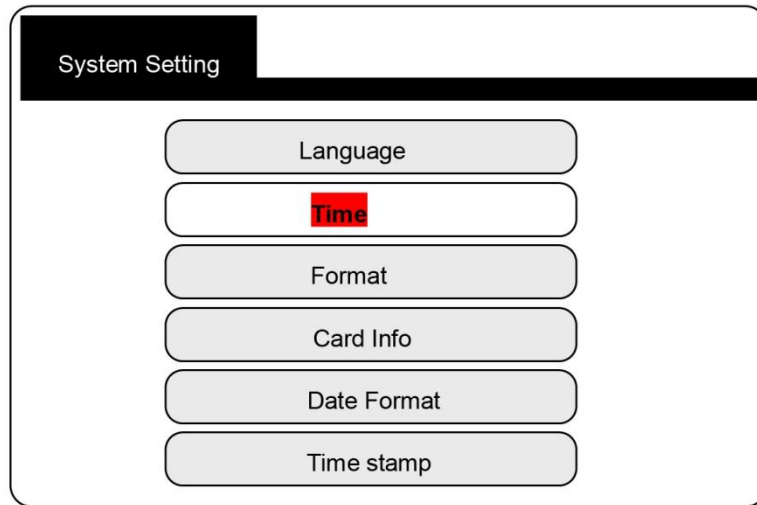

Press the ◀ / ▶ keys to move the cursor.
Press the ▲ / ▼ keys to set the time.
Press the OK button to save the setting.

7.4.3 Formatting

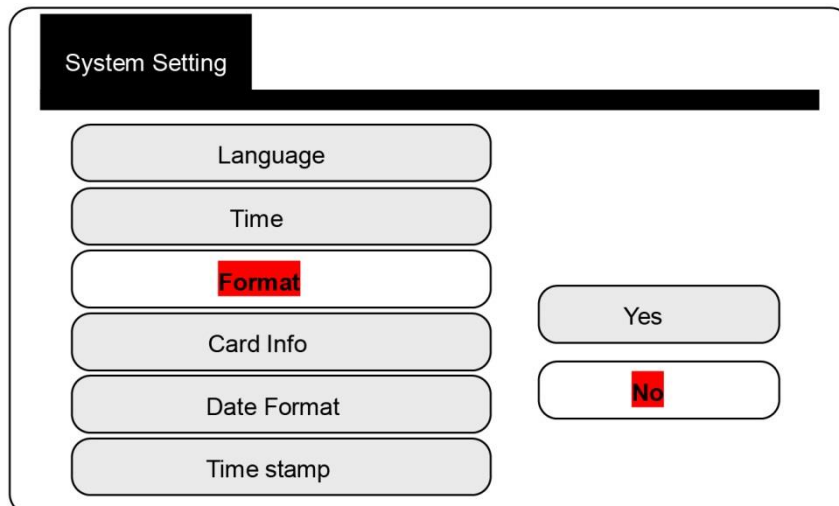

Select "Yes" to format the SD card.

Note: "Formatting" deletes all files from the SD card (the files cannot be restored).

7.4.4 SD card capacity check

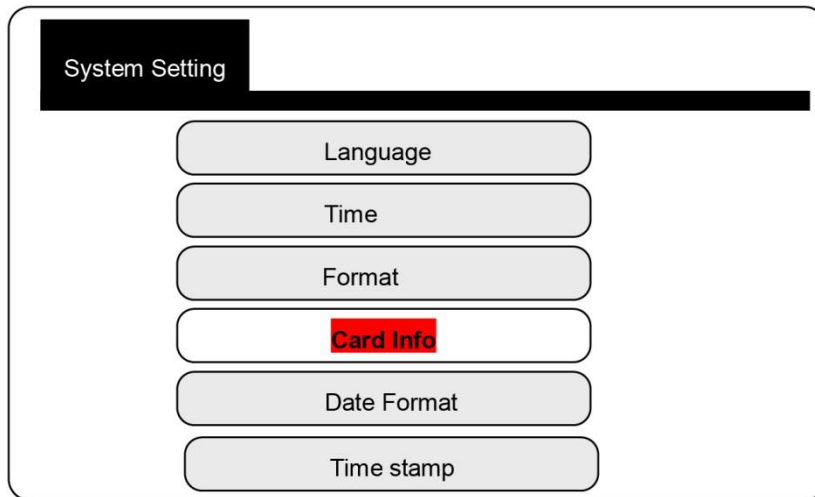

Card info

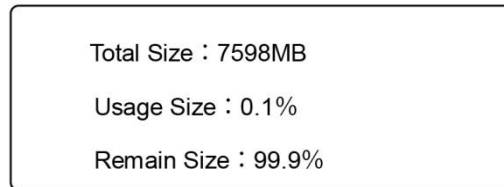

7.4.5 Date format

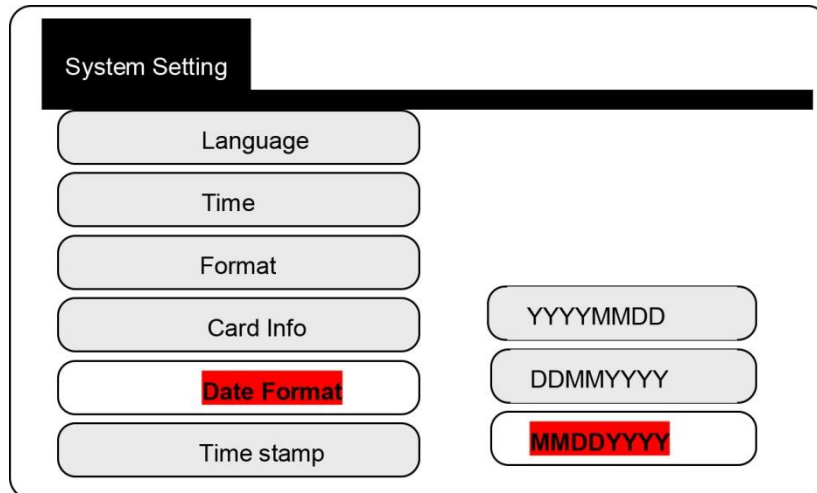

7.4.6 Time display on the screen

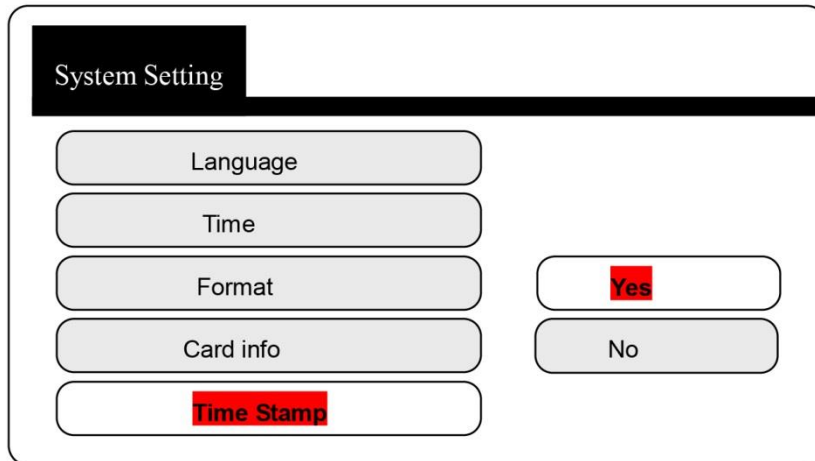

8 FAQ

All the parts have been fastened, but nothing is displayed after turning on the device.	Check carefully whether all the parts have been assembled correctly and whether the battery is sufficiently charged.
The menu does not open.	Check if the status light for the DVR is on. If not, turn on the DVR.
After recording, there is no file on the SD card.	<ol style="list-style-type: none"> 1. Check if the data can be written to the SD card. Insert the card correctly. 2. Check whether the DVR can read the SD card or not.
The recording has no sound.	Check whether the MIC button has been pressed. Use the correct headphones.
The video file is damaged.	Do not remove the SD card while recording.

9 Disposal

For the disposal of batteries in the EU, the 2006/66/EC directive of the European Parliament applies. Due to the contained pollutants, batteries must not be disposed of as household waste. They must be given to collection points designed for that purpose.

In order to comply with the EU directive 2012/19/EU we take our devices back. We either re-use them or give them to a recycling company which disposes of the devices in line with law.

For countries outside the EU, batteries and devices should be disposed of in accordance with your local waste regulations.

If you have any questions, please contact PCE Instruments.



10 Contact

If you have any questions about our range of products or measuring instruments, please, contact PCE Instruments.

10.1 PCE Instruments UK

By post:

PCE Instruments UK Ltd.
Units 12/13 Southpoint Business Park
Ensign Way, Southampton
Hampshire

United Kingdom, SO31 4RF

By phone:

02380 987 035

10.2 PCE Americas

By post:

PCE Americas Inc.
711 Commerce Way
Suite 8
Jupiter
33458 FL
USA

By phone:

561 320 9162