



PCE Americas Inc.  
1201 Jupiter Park Drive  
Suite 8  
Jupiter  
FL-33458  
USA  
From outside US: +1  
Tel: (561) 320-9162  
Fax: (561) 320-9176  
info@pce-americas.com

PCE Instruments UK Ltd.  
Unit 11  
Southpoint Business Park  
Ensign way  
Hampshire / Southampton  
United Kingdom, SO31 4RF  
From outside UK: +44  
Tel: (0) 2380 98703 0  
Fax: (0) 2380 98703 9  
info@pce-instruments.co.uk

[www.pce-instruments.com/english](http://www.pce-instruments.com/english)  
[www.pce-instruments.com](http://www.pce-instruments.com)

# Manual

## Ultrasonic Hardness Tester PCE-5000



Version 1.3  
Date of creation: 16.02.2015  
Date of last change: 06.01.2021

## Contents

<b>1</b>	<b>Introduction .....</b>	<b>3</b>
<b>2</b>	<b>Safety notes.....</b>	<b>3</b>
<b>3</b>	<b>Specifications.....</b>	<b>5</b>
3.1	Technical Specifications .....	5
<b>4</b>	<b>Delivery content .....</b>	<b>6</b>
4.1	Optional accessories .....	6
<b>5</b>	<b>System description .....</b>	<b>7</b>
5.1	Main structure and basic principle .....	7
5.2	Control elements .....	8
5.3	Display .....	9
5.4	Measurement probe .....	10
<b>6</b>	<b>Battery.....</b>	<b>13</b>
<b>7</b>	<b>Operation .....</b>	<b>14</b>
7.1	Initial operation .....	14
7.2	Measurement.....	14
<b>8</b>	<b>Settings.....</b>	<b>16</b>
8.1	Test setup .....	16
8.2	System setup.....	17
8.2.1	Language option.....	17
8.2.2	Sound .....	17
8.2.3	Battery manager .....	17
8.2.4	Display .....	17
8.2.5	Date .....	17
8.2.6	Restore default .....	17
8.3	Save setup.....	17
8.3.1	Autosave.....	17
8.3.2	Result display .....	17
8.3.3	On-line operation .....	17
8.3.4	Part deletion .....	17
8.3.5	All deletion .....	17
8.4	Print setup.....	18
<b>9</b>	<b>Calibration .....</b>	<b>18</b>
9.1	Reasons to calibrate.....	18
9.2	Preparations .....	18
9.3	Calibration procedure .....	18
9.3.1	Calibration with two calibration standards .....	18
9.3.2	Calibration with one calibration standard .....	18
9.3.3	Batch-Mode .....	19
<b>10</b>	<b>Disposal .....</b>	<b>20</b>
<b>11</b>	<b>Contact.....</b>	<b>20</b>
11.1	PCE Instruments UK .....	20
11.2	PCE Americas .....	20

## 1 Introduction

Thank you for purchasing an ultrasonic hardness tester from PCE Instruments.

The ultrasonic durometer is a device, based on a patent filed in 1961. Therefore the hardness measurement is performed through a diamond placed on a spring. Due to its design and measurement method, the ultrasonic durometer allows a simple and non-destructive analysis of metallic objects. The ultrasonic durometer enables measurements on various construction parts, since it is programmed to measure with different SI-units, the most common of which are the hardness scales according to Rockwell, Brinell and Vickers. Featuring a RS-232-interface the ultrasonic durometer PCE-5000 can be connected to a computer in order to read out and print out the measured data. The ultrasonic durometer allows a detailed overview of all the data, since it can record even the thresholds as well as mean values. The mean value is automatically generated as soon as more than one measurement is performed with the ultrasonic durometer PCE-5000. Its design allows reaching even locations that would be otherwise hard to reach, and it allows reviewing and reading the values comfortably at its graphic display. Due to an option to calibrate, the ultrasonic durometer can be always calibrated by the user at any time. A calibration might be necessary, if for example the last measurement was more than three months back, or when the environment is significantly different from before, if the ultrasonic sensor has already performed a major amount of measurements, or if the measurement of a defined calibration object shows a divergent.

### Range of use

- Hardness measurements of the flanged edge and gear root stamping, mold, sheet, surface hardened tooth and gear groove
- Hardness tests of central axes, thin-walled pipes and vessels
- Hardness testing of tires and turbine rotor
- Hardness tests of cutting blades
- Hardness testing of welded parts
- Hardness tests of certain opening depths, convex depressions, irregular levels
- Hardness tests of most ferrous and non-ferrous metals and other alloys in industrial production.

## 2 Safety notes

Please read this manual carefully and completely before you use the device for the first time. The device may only be used by qualified personnel and repaired by PCE Instruments personnel. There is no warranty on damages or injuries caused by non-observance of the manual.

- The device may only be used in approved temperature range
- The opening of the case should only be done by qualified personnel of the PCE Instruments.
- The instrument should never be placed with the user interface (e.g. keyboard side on a table)
- You should not make technical changes on the device
- The appliance should only be cleaned with a damp cloth / use only pH-neutral cleaner
- Do not shake the device since internal components may get damaged.
- Do not scratch objects with the diamond.
- Do not disassemble the unit. Otherwise the warranty will expire.
- Do not use the instrument under inflammable air environment, otherwise it may take fire or explode.

The ultrasonic hardness tester is a precision instrument that must be used with extreme care to avoid damage and associated measurement error.

Remove the diamond indenter mentioned above for about half a second after each measurement and then make a new measurement. Otherwise, the device cannot resonance between the indenter and a single sample in a short time.

Please ensure that after each use, the device is always kept in the respective carrying case. Avoid accidents and collisions.

Do not disconnect the probe from the main unit, since otherwise the device loses its functionality.

Do not use the product near flammable gas, as this could result in fire or explosion.

**Charger:**

- Only use the original manufacturer's battery
- Do not disassemble the battery
- When inserting the battery, make sure that it is properly seated and the poles were not mistaken
- Do never throw the battery into fire and never bring it in intense heat
- Do not throw the battery into water and also do not touch the water
- If the battery should be deformed, do not use it
- Turn off the power before removing or changing the battery
- Before leaving our factory, the battery is inserted correctly, you do not make any changes unless absolutely necessary

**Recharger:**

- Store the device in a dry state
- Avoid short circuits, they will destroy the device
- Do not touch the recharger with wet or damp hands; otherwise there is a danger of an electric shock

**Declaration:**

- Without the prior written consent of the Company and subsidiaries, for all products that are referring to the contents of this manual, copies are distributed in any form, or stored in a retrieval system, or translated into other languages
- The Company reserves the right to change information on soft- and hardware without notice
- All efforts have been geared to grant the correctness and accuracy of the information contained in this manual. If you still encounter any defects or errors, we strive to correct this in the next edition

This user's handbook is published from PCE Instruments without any guarantee.

We expressly point to our general guarantee terms, they can be found in our general terms of business.

If you have any questions please contact PCE Instruments.

### 3 Specifications

There are different kinds of methods for measurement of hardness:

Brinell, Rockwell, Vickers, Leeb, etc. are usually used.

Rockwell and Brinell tests force with larger test loads and large stamps what often leads to visible damage to the material surface. The hardness-measuring of heavy work pieces, built-in machinery and permanently assembled parts is therefore relatively difficult.

The ultrasonic hardness tester PCE-5000 uses the Ultrasonic Contact Impedance procedure to carry out comparative hardness measurements for test pieces, with the advantages of a highly accurate, efficient, portable and non-destructive measurement with simple operation.

#### 3.1 Technical Specifications

<b>Measurement range</b>	
Rockwell	20,3 ... 68,0 HRC 41,0 ... 100,0 HRB 61,0 ... 85,6 HRA
Brinell	85 ... 650 HB
Vickers	50 ... 999 HV
Tensile strength	255 ... 2180 N/mm <sup>2</sup>
<b>Accuracy</b>	
Rockwell HRD	±1,5 HR
Brinell HB	±3 %
Vickers HV	±3 %
<b>General technical data</b>	
Measurement principle	Ultrasonic Contact Impedance
Direction of measurement	360 °
Measurement time	2 seconds
	HRC, HV, HB, additionally: HRA, HRB, MPa
Display	LCD with backlight
Minimum material thickness	2 mm
Storage	Up to 2000 measurement groups up to 20 calibration sets
Measurement probe	20 N (standard)
Cable length	1,5 m
Functions	Single value, Min. / Max., average value
Power supply	4,2 V battery, 4800 mAh
Operation time	Approx. 10 hours (without backlight)
Automatic shutdown	After 30 minutes of inactivity
Operation conditions	Temperature: -10 ... +40°C Humidity: ≤ 85 % r.h.
Storage conditions	Temperature: -20 ... +60°C Humidity: ≤ 85 % r.h.
Dimensions	162 x 81 x 31 mm
Weight	Approx. 755 (incl. probe)

## 4 Delivery content

- 1 x ultrasonic hardness tester PCE-5000 incl. battery
- 1 x testing probe 20 N (standard)
- 1 x probe cable
- 1 x USB cable
- 1 x charger
- 1 x calibration standard
- 1 x screwdriver
- 1 x protective cap (silicone)
- 1 x RS-232 interface cable
- 1 x robust carry case
- 1 x user manual

### 4.1 Optional accessories

#### Probes

There are different probes depending on the testing forces available:

- 3 N
- 5 N
- 8 N
- 10 N

#### Supporting rings

Supporting rings serve to stabilize the measurement tip on the surface to be tested.

- PCE-SRZK
- PCE-SRZG
- PCE-SRF

#### Test stand

The test stand PCE-HSS increases the accuracy and repeatability of hardness measurements.

## 5 System description





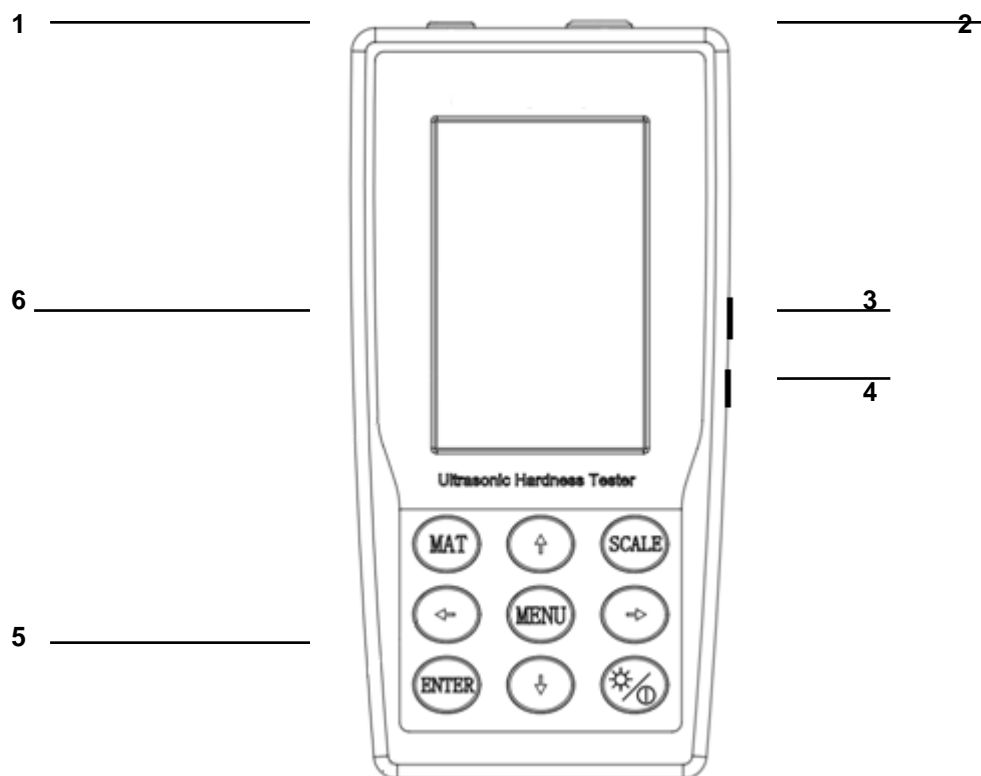

### 5.1 Main structure and basic principle

Front and back view of the ultrasonic hardness tester

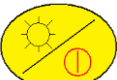

1. 4-pin socket
2. 8-pin socket
3. Power button
4. USB-interface
5. Operation panel
6. Display

## 5.2 Control elements

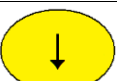
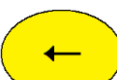
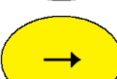
Button	Designation	Function
	Material	In measurement mode: open material menu In material menu: choose material
	Measurement unit	In measurement mode: choose measurement unit In material menu: delete In hardness scale menu: change between ASTM / DIN In test result menu: open search function In deletion menu: delete
	Enter	In measurement mode: start measurement In menu: back
	Menu	During measurement: open menu In menu: back
	Power on / off, brightness	Press shortly: switch on / off backlight Press long: switch on / off the device
	High	Move upwards When in searching mode: increase chosen digit
	Down	Move downwards When in searching mode: decrease chosen digit
	Left	During measurement: increase contrast of display In menu: move left In input field: decrease value
	Right	During measurement: decrease contrast of display In menu: move right In input field: increase value



### 5.3 Display

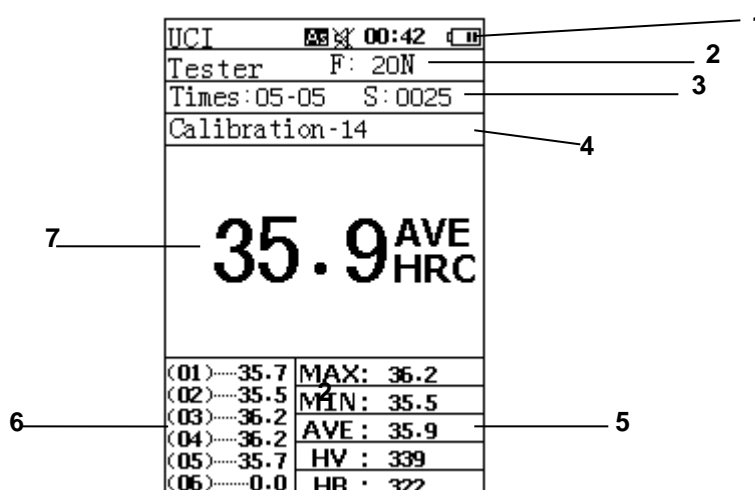

1. Settings
2. Probe type
3. Measurement information
4. Material information
5. Measurement results
6. Single measurements of the test series
7. Measurement result

#### Settings

The following settings are displayed:

- Auto-save (on/off)
- Sound (on/off)
- Time
- Battery condition

#### Probe type

The instrument gives information on the assembled probe and its' testing force. The standard probe type has got a preset testing force of 20 N.

#### Measurement information

Here you can see how many measurements have to be made in the current test series. In addition to that you can see in which slot the measured data has been stored.

#### Material information

Here you can see which material / calibration profile is in use.

#### Measurement results

All measured data of the test series are displayed here. It is the average of all made measurements of the test series.

#### Single measurements of the test series

Here you can see how many single measurements have been made and what the values of the single measurements are.

#### Measurement result

Here the current measurement result is displayed. You can see the MAX/MIN value as well as the mean value of two other hardness scales.

### 5.4 Measurement probe

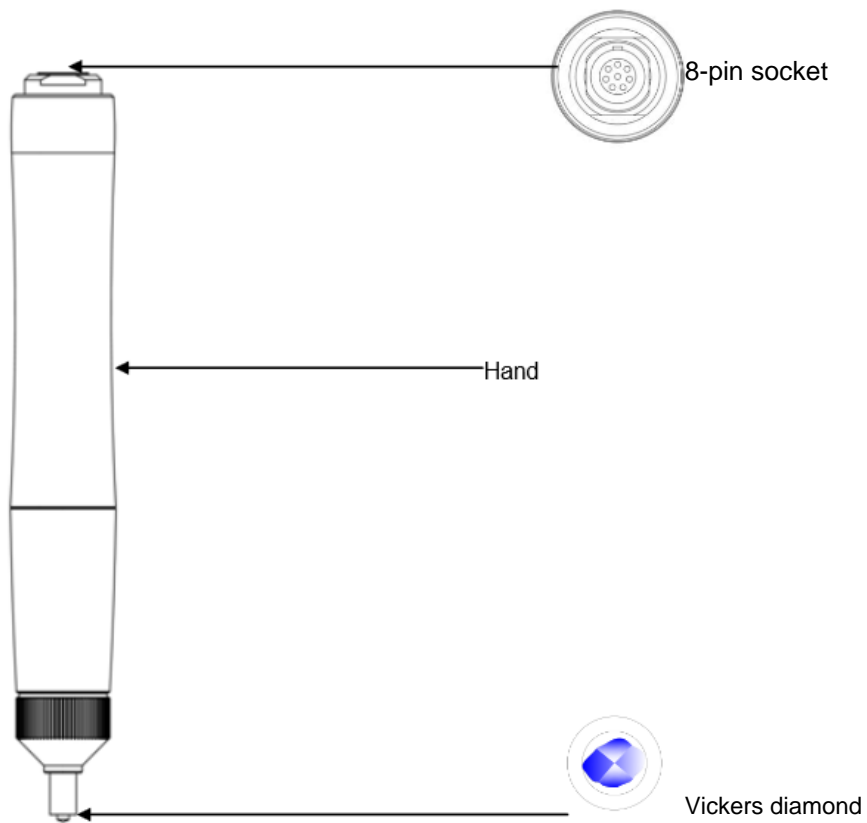

Note:  
The standard probe is preset to 20 N. Other probes are available as optional accessory.

**Ultrasonic indenter and recesses**

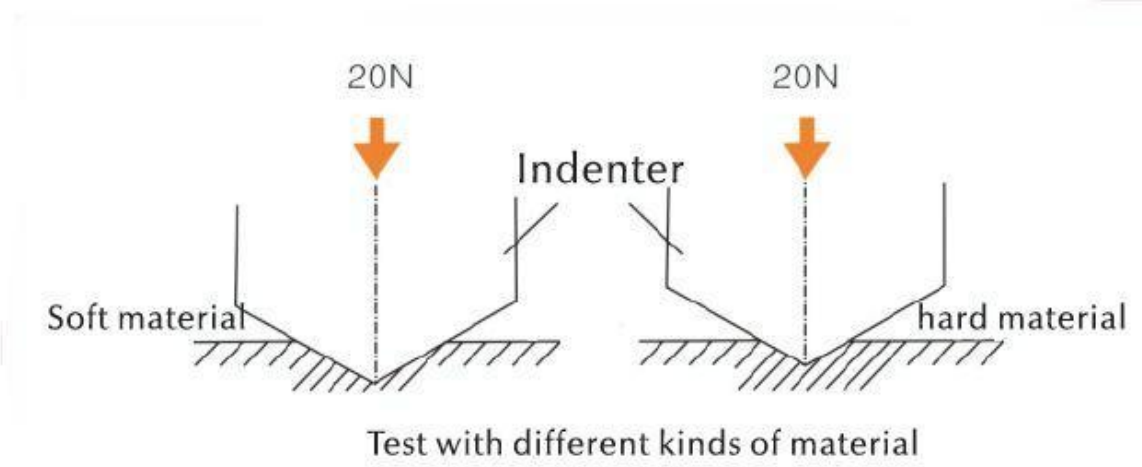
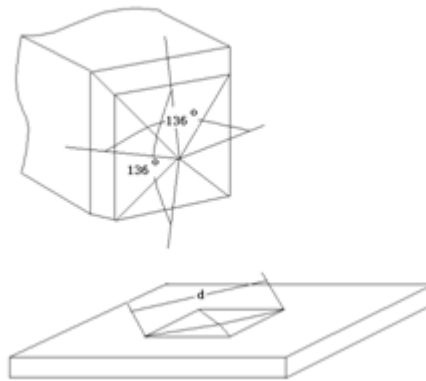

During measurements the inspection stamp entrudes minimally within the material. The indentation depth (H) and the mean value of the diagonal lengths (d) of the various probes of the ultrasonic hardness tester can be reduced with increasing value.

Material hardness (HV)	Depth (µm)
800	10
600	11
300	16
Material hardness (HV)	Diagonal line of the impression of the inspection stamp
800	68
600	79
300	111

Note: The table only shows the values for the 20 N probe.

**Minimum thickness of the tested object**

Despite the low penetration depth the workpiece needs to have a minimum thickness so that the instrument is not damaged. The minimum thickness of the material should be at least ten times higher than the penetration depth.

Penetration depth h:

$$h = 0,062 \sqrt{\frac{F}{HV}}$$

F: preset test force

HV: Vickers hardness of the material

Minimum thickness t:  $t \leq 10 h$

Material hardness (HV)	Minimum material thickness (µm)
800	100
600	110
300	160

Note: The table only shows the values for the 20 N probe.

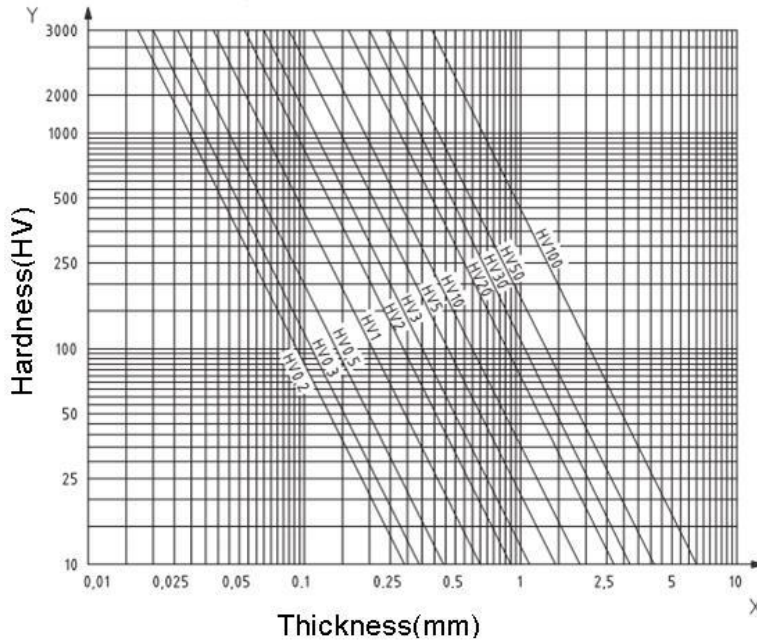

**Condition of the surface**

The applied test force (i.e. the selected UCI probe) must not only match the application but also the surface quality and roughness of the material. While smooth, homogeneous surfaces with low test loads can be measured, rougher surfaces and coarse-grained require measurements with high test loads. However, the surface must always be free of contaminants (oil, dust, etc.) and rust.



**Dimensions and weight of the part to be tested**

From the above analysis, all probes request coating layer or surface layer less than 1 mm. The hardness value will change if there is resonance. The highest value of vibration is the elastic oscillation, where some actions can be made in order to restrain these. To do so the piece has to be put on thicker metal. Rubber and oil can restrain elastic waves. It is recommended to use pieces that have a thickness of 2...3 mm and a size, which is not less than 5 x 5 mm.

Also the weight of the material is important. Depending on the weight certain preparations have to be made:

Weight	>300 g	100 ... 300 g	10 ... 100 g
Action	Measurement can be made under normal conditions	Use supporting ring	Couple to heavy component

## 6 Battery

The main unit includes a rechargeable battery (charger, 4.2 V, 4800 mAh). You can find the battery lid on the back of the device. When the battery is flat the symbol “” appears in the upper right corner from the main menu, to remind you to charge the battery in time. Plug one end of the charger into the left socket of the instrument and insert the plug into a 230 V outlet and charge the device completely. After 8 hours, the device is fully charged; The minimum charging time is two hours. When the device is fully charged, “” is displayed in the upper right corner of the screen.

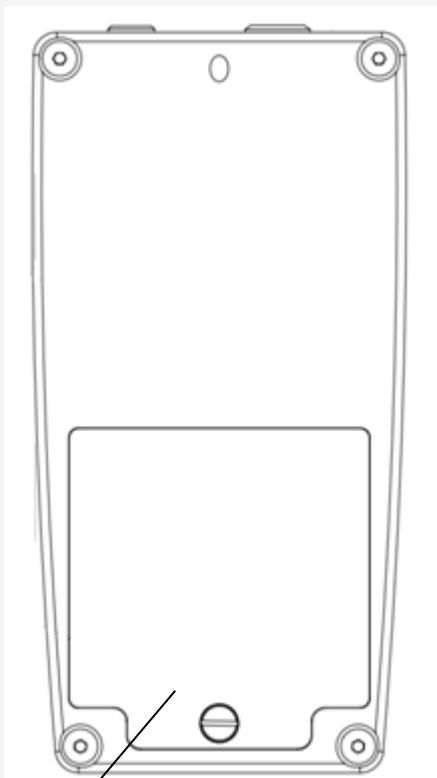

Battery lid

## 7 Operation

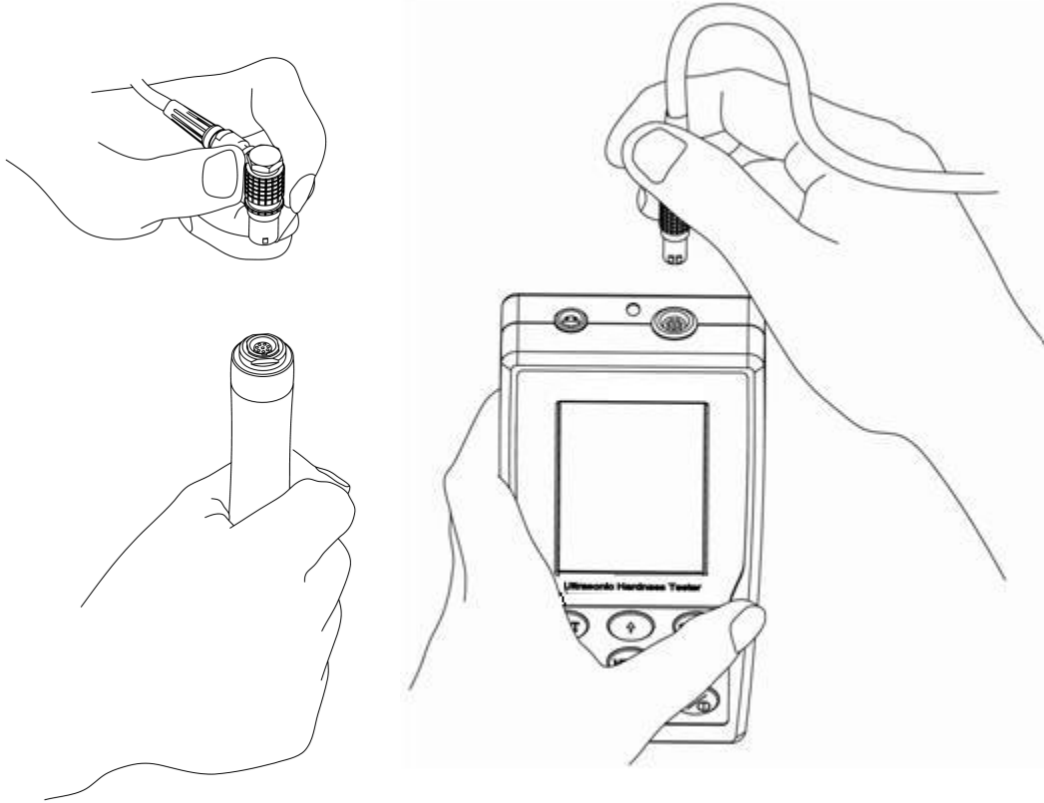

### 7.1 Initial operation

Connect the angle plug of the 8-pin data cable to the 8-pin connector of the probe together. If you hear a clicking noise, the device is in the correct position. Now connect the other end of the 8-pin data cable to the 8-pin connector of the ultrasonic hardness tester. Match with the positions of the groove and put them together. When you hear a clicking sound, the connections are correct.



### 7.2 Measurement

To perform a measurement, follow these steps:

1. Press "Power" , and move the "ON/OFF" switch to "ON", so that the power supply is turned on. You will reach the main menu then.
2. Press the "Scale"-Button to select the measurement scale and press the "ETR"-button. The measurement mode will start then. After that the symbol  is displayed.
3. Hold the probe with both hands vertical to the test object. Press down the inspection stamp until the measurement tip is not visible anymore and the protective ring is lying flat on the test material.

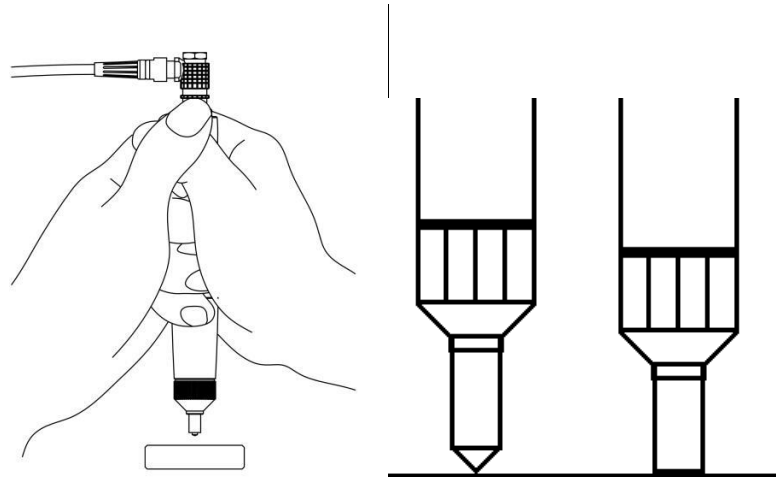

4. Hold the probe for about 2 seconds in this position until the measurement is complete. The device then sends a signal, which states that the measurement is complete and the measured values can be read from the display. The first reading is not included in the determination of the average value.

UCI		00:42	
Tester		F: 20N	
Times: 05-05		S: 0025	
Calibration-14			
<b>35.9 AVE HRC</b>			
(01)	35.7	MAX:	36.2
(02)	35.5	MIN:	35.5
(03)	36.2	AVE:	35.9
(04)	36.2	HV :	339
(05)	35.7	HB :	322
(06)	0.0		

Note:

- Normally five measurements, made within 645 mm<sup>2</sup> suffice to get usable results. If the test material is very inhomogeneous you should make more than five measurements to get usable results.
- In case you changed the amount of the single measurements in the settings, you need to stick to that setting. Otherwise the measurement is not completed.
- The ultrasonic hardness meter is a highly precise instrument. Take care to always hold the probe with two hands in the vertical position. Do not put the probe under different pressure and take care that no impacts occur during measurements. When lifting the probe pay attention that you do not scratch the material with the diamond.
- Check the accuracy and the repeatability regularly. Use the calibration standard which is delivered with the instrument. To check the characteristics you need to perform 5 measurements as described above and compare the results that are noted on the calibration standard. If the deviations should be too big, you need to calibrate the instrument.

## 8 Settings

Press the menu-button to get to the main menu. There are the following options:

- Test setup
- System setup
- Save setup
- Print setup

Choose the required submenu and confirm with "Enter".

### 8.1 Test setup

#### Calibration

Here you can see all calibrations for the different materials that you have made. Choose the calibration you need by using the arrow buttons and confirm with the "MAT" key to use the calibration. There will be a checkmark in front of the chosen option.

If you need to delete a calibration go to the calibration to be deleted and press the "SCALE" key. If you choose "YES" in the confirmation screen and press "ENTER", the calibration will be deleted. By choosing "NO" the procedure will be cancelled.

If you wish detailed information on the calibrations, choose the one you need to know more about and press "ENTER". You will be redirected to the information screen, where you can view the measured and entered data. By pressing the "SCALE" key you can rename the calibrations. Use arrow and "ENTER" keys to confirm the entered data.

Note: When in measurement mode you can also get into this mode by pressing the "MAT" key.

#### Hardness scale

Here you can choose the measurement unit, in which the measurement data should be displayed by default.

Choose between: HB, HRC, HV, HRA, HRB and MPA. By pressing the "SCALE" key you can also choose between ASTM and DIN.

Choose the correct unit by using the arrow keys and confirm with "ENTER".

#### Test number

Here you can set how many single measurements have to be made during one measuring process. Use the left and right arrow keys to increase or decrease the number and confirm with "ENTER".

#### Calibration setup

See chapter "Calibration".

#### Error permit

Here you can set the upper and lower error tolerances. Use the high and low arrow keys to switch between input fields. By using the left and right arrow keys you can increase or decrease the chosen value. Confirm with the "ENTER" key.

#### Batch mode

Here you can activate / deactivate the batch mode. Choose your option and confirm with "ENTER".

#### Test time

Here you can set the test time. Use the left or right arrow key to increase or decrease the value.



## 8.2 System setup

### 8.2.1 Language option

Here you can choose the language of the instrument. You may choose between English, Chinese, Portuguese, Turkish and German. Use the arrow keys to choose and the “ENTER” key to confirm.

### 8.2.2 Sound

Here you can choose what sounds the instruments is supposed to make. Make your choice with the arrow keys and confirm with “ENTER”.

### 8.2.3 Battery manager

You have got two options here. If “ON” is ticked, the instrument switches itself off after 30 minutes of inactivity. If the option “OFF” is ticked, the instrument changes to Standby-mode in case of inactivity. Make your choice by using the arrow keys and confirm with “ENTER”.

### 8.2.4 Display

Here the contrast of the display can be set. Use the right / left arrow keys to move the slide control. Confirm your choice with “ENTER”.

### 8.2.5 Date

You can set time and date here. The following settings can be made: year, month, day, hour, minute and weekday. Choose the correct field with the arrow-up and arrow-down keys and put in the correct settings, using the left and right arrow keys. Confirm your entered data using the “ENTER” key.

### 8.2.6 Restore default

Here you can restore the factory settings. Please enter the password (standard: “888888”) and press “ENTER”. Then press “ENTER” again to confirm the reset. Press the “MENU” key to cancel.

Note: All data is going to be deleted. This includes calibration details, settings and measured data.

## 8.3 Save setup

### 8.3.1 Autosave

Here the automatic storage function can be activated or deactivated. You one option and confirm by pressing “ENTER”.

### 8.3.2 Result display

Here you can review the saved data. The values are assorted by their numbers. With the up / down keys you can scroll through the values. By pressing “ENTER” you can open one slot to get detailed information.

If you need information on one specific slot number, press “SCALE”. A search window will appear. Insert the number you are looking for using the arrow keys and confirm your choice with “ENTER”.

### 8.3.3 On-line operation

Here you can activate the data transmission to a PC. Choose an option by using the arrow keys and confirm with “ENTER”.

### 8.3.4 Part deletion

Here you can choose and delete the storage slots. Use the arrow keys to choose the storage slot and press “ENTER” to choose one slot. If you have chosen all slots, press “SCALE” and confirm by choosing “YES” and pressing “ENTER” afterwards.

### 8.3.5 All deletion

Here you can delete all measured data. Press “ENTER” to confirm and “MENU” to cancel.

Note: This procedure may take some minutes.

## 8.4 Print setup

Here you can print out all measured data or certain data slot. This works just as deletion or part-deletion works.

## 9 Calibration

### 9.1 Reasons to calibrate

- If the readings are stable in the process of reviewing the durometer with the reference block, but the nominal value of the reference hardness block is different.
- After a long storage (more than 3 month)
- After intense using (more than 200.000 measures with the probe)
- When operating conditions have changed considerably (ambient temperature, humidity)

### 9.2 Preparations

For a Rockwell C (HRC) calibration you need two different calibration standards:

- $25 \pm 5$  HRC
- $65 \pm 5$  HRC

Note: If you do not use the whole measuring range of Rockwell C (e.g. only from 20 ... 40 HRC) you may also use a  $25 \pm 5$  and  $45 \pm 5$  HRC calibration standards. The same goes for Vickers.

Note: In special cases, only one block per calibration is necessary.

### 9.3 Calibration procedure

#### 9.3.1 Calibration with two calibration standards

Press "MENU" in the main menu. Move to "test setup" and choose the "Calibration setup". Insert the password ("888888" is the preset standard) and press "ENTER". You will now see the following display:

UCI	10:23	
Settings		
Test setup		
Edit Name	-01 (HV)	
6 times for: TEST-L		
TEST-L:	223	
Normal-L:	223	
TEST-H:	223	
Normal-H:	223	
Up:	000	
Down:	000	
F: 20N		
	227	223
	227	224

Choose by using the arrow keys one free storage slot. Then press "MAT". Now you need to perform six measurements on the soft calibration standard. After doing so the mean value will be shown at "TEST-L". Press "MAT" again and the right-arrow key afterwards. Now you have to make six measurements on the harder block. The mean value will be displayed at "TEST-H".

Now press the "MENU" key to enter the nominal value of the calibration standards. Use the arrow keys to do so. With the "SCALE" key you can set how much the value should be increased or decreased. Press "MENU" to finish the calibration. The new settings are saved and will be set automatically.

Note: If there is an arrow upwards or downwards displayed during the calibration, the measured value is above or below the hardness scale.

#### 9.3.2 Calibration with one calibration standard

The calibration with only one calibration standard is similar to the calibration with two standards. The difference is that you do not calibrate the "TEST-H" part. Press the "MENU" key after "TEST-L" calibration and enter the nominal value. Finish the calibration by pressing "MENU" again.

### 9.3.3 Batch-Mode

Within the calibration settings, you can also enter the tolerance thresholds. If you have entered the upper and lowest value, the instrument shows if the measured value is within that area every time you measure. If the value is within that area the instrument shows "PASS". If the value is not within that area it will display "NG".

To set the tolerances, use the arrow down key after you have set the "TEST-L" and "TEST-H" values. You will now get to the points "UP" and "DOWN". Up stands for the upper threshold, DOWN the lower value. To set the values is made equal to setting "TEST-L and "TEST-H".

## 10 Disposal

For the disposal of batteries, the 2006/66/EC directive of the European Parliament applies. Due to the contained pollutants, batteries must not be disposed of as household waste. They must be given to collection points designed for that purpose.

In order to comply with the EU directive 2012/19/EU we take our devices back. We either re-use them or give them to a recycling company which disposes of the devices in line with law.

If you have any questions, please contact PCE Instruments.



## 11 Contact

If you have any questions about our range of products or measuring instruments please contact PCE Instruments.

### 11.1 PCE Instruments UK

**By post:**

PCE Instruments UK Ltd.  
Unit 11 Southpoint Business Park  
Ensign Way, Southampton  
Hampshire

United Kingdom, SO31 4RF

**By phone:**

02380 987 035

### 11.2 PCE Americas

**By post:**

PCE Americas Inc.  
1201 Jupiter Park Drive  
Suite 8  
Jupiter  
33458 FL  
USA

**By phone:**

561 320 9162