



User Manual

PCE-PFG Series Force Gauge



User manuals in various languages (français, italiano, español, português, nederlands, türk, polski, русский, 中文) can be found by using our product search on: www.pce-instruments.com

Last change: 2 February 2021
v1.0



Contents

1	Safety notes	1
2	Specifications	2
3	Delivery scope	2
4	Dimensions	3
5	Key functions	4
6	Battery	5
7	Switching on and off	5
8	Measuring modes	6
8.1	Real Time.....	6
8.2	Peak.....	6
8.3	Average mode.....	6
8.4	Save mode (Automatic memory).....	12
9	Alarm limits	14
10	Rotate display	16
11	Communication interface and output interface	16
12	More settings	17
12.1	Product information.....	19
13	Contact	19
14	Disposal	19

1 Safety notes

Please read this manual carefully and completely before you use the device for the first time. The device may only be used by qualified personnel and repaired by PCE Instruments personnel. Damage or injuries caused by non-observance of the manual are excluded from our liability and not covered by our warranty.

- The device must only be used as described in this instruction manual. If used otherwise, this can cause dangerous situations for the user and damage to the meter.
- The instrument may only be used if the environmental conditions (temperature, relative humidity, ...) are within the ranges stated in the technical specifications. Do not expose the device to extreme temperatures, direct sunlight, extreme humidity or moisture.
- Do not expose the device to shocks or strong vibrations.
- The case should only be opened by qualified PCE Instruments personnel.
- Never use the instrument when your hands are wet.
- You must not make any technical changes to the device.
- The appliance should only be cleaned with a damp cloth. Use only pH-neutral cleaner, no abrasives or solvents.
- The device must only be used with accessories from PCE Instruments or equivalent.
- Before each use, inspect the case for visible damage. If any damage is visible, do not use the device.
- Do not use the instrument in explosive atmospheres.
- The measurement range as stated in the specifications must not be exceeded under any circumstances.
- Non-observance of the safety notes can cause damage to the device and injuries to the user.

We do not assume liability for printing errors or any other mistakes in this manual.

We expressly point to our general guarantee terms which can be found in our general terms of business.

If you have any questions please contact PCE Instruments. The contact details can be found at the end of this manual.



2 Specifications

Model	Measurement range	Resolution
PCE-PFG 20	0 ... 20 N	0.005 N
PCE-PFG 50	0 ... 50 N	0.01 N
PCE-PFG 100	0 ... 100 N	0.02 N
PCE-PFG 200	0 ... 200 N	0.05 N
PCE-PFG 500	0 ... 500 N	0.1 N
PCE-PFG 2K	0 ... 2000 N	0.5 N
Accuracy	0.3 % of measurement range	
Units	N, kgF, lbF	
Sampling rate	500 Hz	
Display	1.8" graphic display	
Alarm modes	Below, Inside, Outside	
Memory	100 measurements	
Power supply	Lithium battery 3.7 V / 1500 mAh	
Battery life	up to 36 h	
Mains adaptor / USB charging adaptor	5 V / 1 A	
Outputs	Interface: USB B, switching output / alarm modes: MD6 with 2.85 V when active	
Protection class	IP 54	
Operating and storage conditions	5 ... 45 °C, 35 ... 65 % RH, non-condensing	
Dimensions	189 x 707 x 34 mm	
Weight	450 g	
Models with external load cell		
Dimensions / weight load cell	L 52 mm / H 72 mm / W 19 mm / M12 thread / 490 g	
Cable length external load cell	approx. 1.8 m	
Handheld dimensions	189 x 707 x 34 mm	
Handheld weight	240 g	

3 Delivery scope

For force gauges PCE-PFG 20, 50, 100, 200 and 500:

- 1 x flat head adaptor Ø13 mm
- 1 x pointed head adaptor
- 1 x hook adaptor
- 1 x extension rod (75 mm)
- 1 x USB cable
- 1 x USB charger
- 1 x user manual
- 1 x plastic carrying case

For the force gauge PCE-PFG 2K:

- 1 x 2000 N S measuring cell
- 2 x M12 joint eyes
- 2 x pressure fittings
- 1 x USB cable
- 1 x USB charger
- 1 x user manual
- 1 x plastic carrying case

4 Dimensions



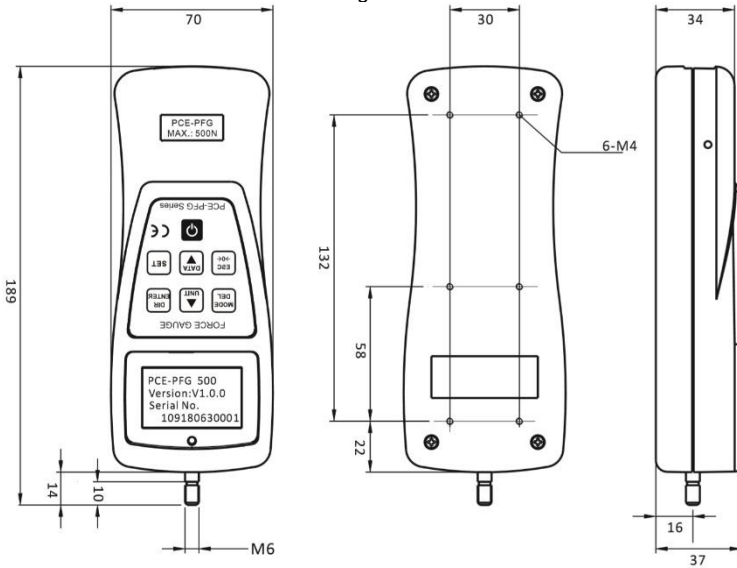

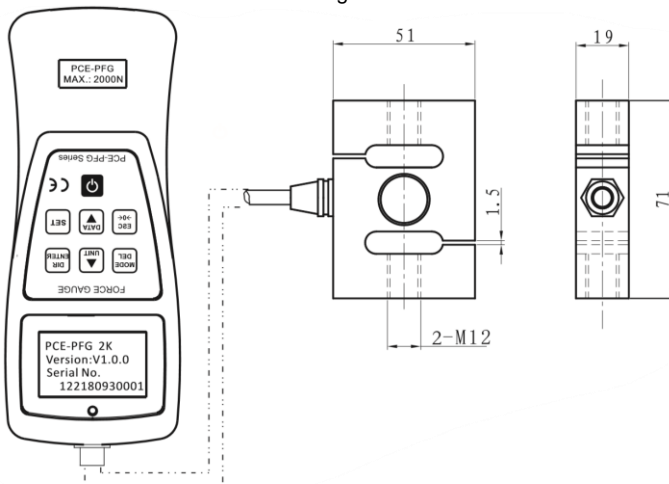

Dimensions for models with internal measuring cell



Dimensions for models with external measuring cell



5 Key functions

Key	Description
	"Power" key for switching the meter on and off
	"MODE" key to select between the individual modes "DEL" key to delete individual values
	"UNIT" key <ul style="list-style-type: none"> - Setting the unit in measuring mode - Increasing displayed parameter - Selecting the next item in the menu
	"Enter" key to confirm the entry or to open a menu item "DIR" key for switching between compressive and tensile alarm display
	"ESC" key to exit the menu "Zero" key to reset the zero point
	"DATA" key: <ul style="list-style-type: none"> - Select the next item in the menu - Call up data memory
	"SET" key: <ul style="list-style-type: none"> - to enter the menu - to select a menu item - to apply settings

6 Battery





The force gauge has a built-in 3.7 V rechargeable battery. If the meter is stored for a longer period of time, it should be recharged because the battery discharges itself. The battery is recharged after approx. 6 hours.



When the battery is charging, the following icon is displayed: 

When the battery is fully charged, the icon  appears on the display.

When switched on, the battery indicator shows the current battery capacity when no charger is connected.

Battery capacity	Icons
100 %	
75 %	
50 %	
25 %	
0 %	

As soon as the battery is discharged, the force gauge switches itself off.

7 Switching on and off



To switch the force gauge on / off, press and release the  key once. When the force gauge is switched on, the model, version number and serial number are displayed.

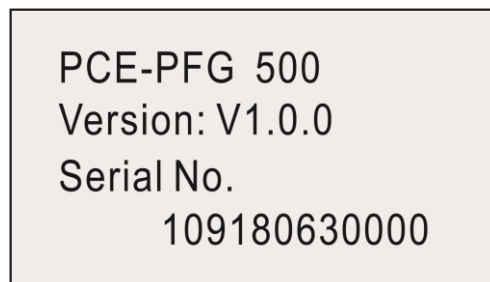

8 Measuring modes

There are four different measuring modes in this force gauge. If the tensile or compressive force is outside the measurement range, "OVER" is shown on the display. An acoustic signal is also generated. Only when the measured value is back within the measurement range, a normal measurement can be resumed.



To select between the modes, press the **MODE DEL** key in the current measuring mode. The current measuring mode is displayed below the measured value.

Note: Zeroing can only be performed within the range of 10 % of the total capacity.

8.1 Real Time

In Real Time (RT) measuring mode, the current measured value is continuously displayed.

8.2 Peak

In peak mode (PK), the highest measured value is displayed and held. This measuring mode can



be used for tensile and compressive force. The peak value is reset with the key

8.3 Average mode

In Average (AVG) mode, the average value of a measurement is displayed. This mode can be used, for example, for peel force, friction force and other tests where an average value is required. There are two different functions in this measuring mode.

MOD1: With this function, the average value of the force curve is displayed from the set smallest force and over the set period of time.

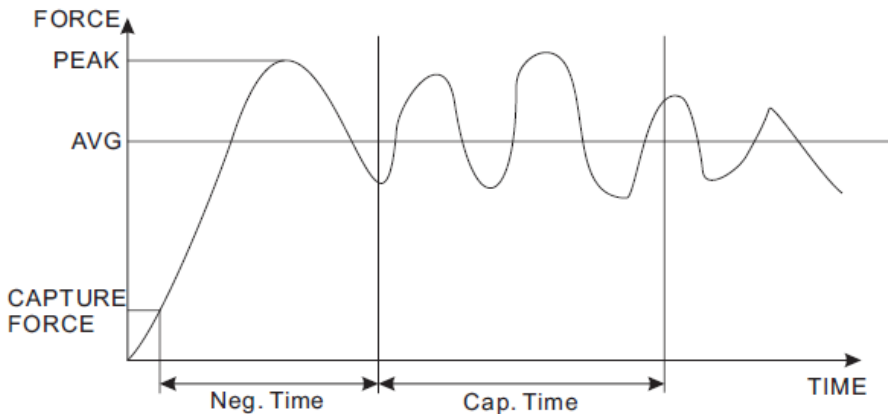

MOD2: This function calculates the average above the set smallest measured value. When the measured value falls below the set smallest measured value again, the measurement is finished. This measuring procedure is possible over a period of 10 minutes.

As long as the measurement time of 10 minutes is not exceeded, this measurement can be resumed at any time.

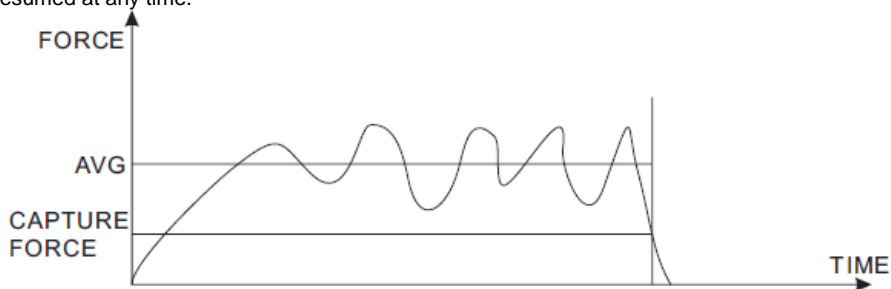

SET

To make settings in this measuring mode, press the **SET** key twice.

A. M. C. F: 69.0
 Neg. Time: 6.5
 Cap. Time: 29.0
 Ave. Mode: MOD1

**DIR
ENTER**



To select a parameter, use the arrow keys. Press the **DIR ENTER** key to select a parameter. Use

**DIR
ENTER**

the arrow keys again to change the parameter properties. Press the **DIR ENTER** key to apply the settings you have made.



Setting	Meaning
A.M.C.F. Average Minimum Capture Force	Here you set the force at which the average measurement is to start.
Neg. Time Neglectful Time	Here you enter the time span at the beginning of the measurement that is not yet to be taken into account in the average measurement. Available settings: 0.0 ... 300.0 s. Resolution: 0.1 s. This parameter only affects the MOD1 function.
Cap. Time Capture Time	Here you set the measuring time for the average measurement. Available settings: 0.0 ... 300.0 s. Resolution: 0.1 s. This parameter only affects the MOD1 function.
Ave. Mode	Here you select between the MOD1 and MOD2 function.

To reset and save the average value, press the  key. Up to 20 average values can be saved. To view, delete or export these data, press the  key. Now select "Average" with the arrow keys. Confirm the selection with the  key.

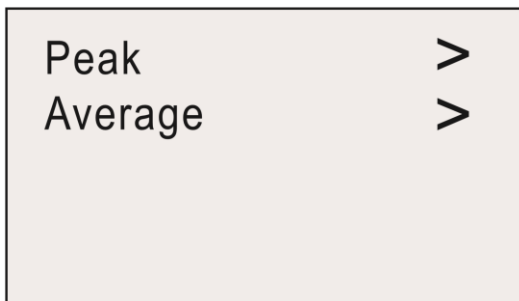

Now you get a choice of four options.

View Ave. Data
View Ave. Stat.
Send Ave. Data
Clear All Ave.

Selection	Description
View Ave. Data (Read out the memory of the average measurement)	Here you can read out the memory of the average measurement and delete individual saved measured values.
View Ave. Stat.	An average evaluation of all average measurements is carried out here.
Send Ave. Date	Here, the saved measurement data are transferred directly to a PC.
Clear All Ave.	Deletes all average measurement data.

DIR
ENTER

Select the desired function with the arrow keys. Press the key to open the function. Press

ESC
→0←

the key to return.

> 00= 23.9 01= 45.8
 02= 98.6 03= 78.4
 04= 54.9 05= 23.4
 06= 23.4 07= 54.2
 08= 54.3 09= 67.2

N Page 01 / Total 01



When viewing all saved measured values, you can select the desired measured value with the

SET

arrow keys. Use the

MODE
DEL

key to switch between the individual pages. Use the key to delete the selected value.

Max: 98.6	N
Min: 23.4	N
Ave: 52.4	N

In the summary of the average readings, you will see the highest, the lowest, the number of readings and the overall average.

SENT FINISH

Under "Send Ave. Data", all data are sent to the PC. After all data have been sent, "SENT FINISH" appears on the display.

CLEAR
OVER

With the function "Clear All Ave.", you can clear the memory. As soon as clearing is completed, "CLEAR OVER" appears on the display.

8.3.1 Measuring procedure

If "WAIT" is displayed on the screen, the meter waits until the set minimum load is applied.

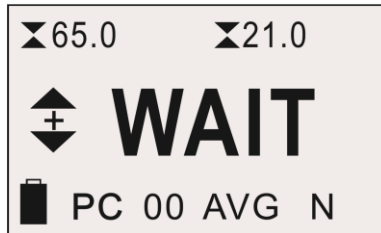

If "I.DLY" is shown on the display, the force gauge will wait until the set minimum time has elapsed.



If the minimum load is present and the minimum time has elapsed, the actual measurement begins. "GATHER" appears on the display. The measurement is made. During this measurement, it is not possible to see the current measured value.



When the measurement is completed, the display shows "DONE".

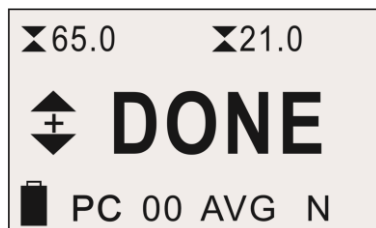





8.4 Save mode (Automatic memory)

In "SAVE Mode", the highest measured values can be saved in a single measurement run. Sufficient memory space for 100 measured values is available (memory items no. 00 ... 99). The number of memory items used is displayed to the left of "SAVE". As soon as a single measurement run is completed, the highest measurement value is automatically saved. The minimum load for this function is specified in the settings under P.M.C.F. To evaluate the data,



press the  key. Then press  to select "PEAK".

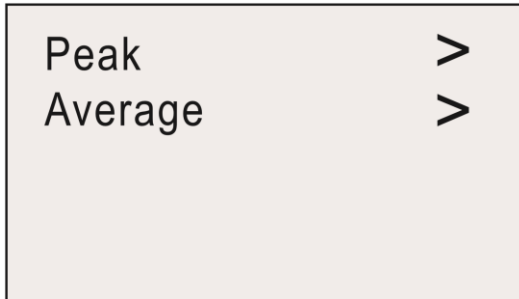

The following options are now available:

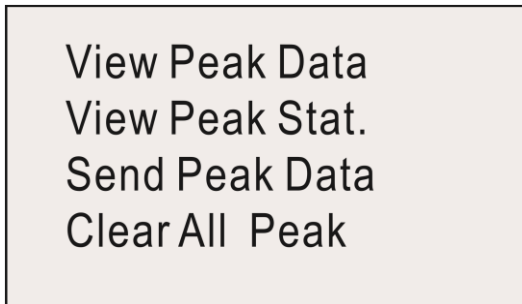

Selection	Description
View Peak Data (Read out the memory of the peak values)	Here you can read out the memory of the peak values and delete individual saved measured values.
View Peak Stat.	The highest, lowest and average of all peak values are displayed here.
Send Peak Date	Here, the saved measurement data are transferred directly to a PC.
Clear All Peak	Deletes all peak readings.



Use the arrow keys to make your selection here. Use the to  select the desired function.

> 05= 23.9	06= 45.8
07= 98.6	08= 78.4
09= 54.9	10= 23.4
11= 23.4	12= 54.2
13= 54.3	14= 67.2
N	Page 01 / Total 01

When viewing all saved measured values, you can select the desired measured value with the



arrow keys. Use the



key to switch between the individual pages. Use the key to delete the selected value.

Max: 98.6	N
Min: 23.4	N
Ave: 52.4	N
Total: 10	

The peak summary shows you the highest, the lowest, the number of readings and the total peak.

SENT FINISH

Under "Send Peak Data", all data are sent to the PC. After all data has been sent, "SENT FINISH" appears on the display.



Use the "Clear All Peak" function to clear the memory. Once clearing is complete, the display shows "CLEAR OVER".

9 Alarm limits

The alarm limits function is useful, for example, to check during quality control whether the sample is working within the specified tolerances. Two limits can be set here. If the measured value is lower than the set "Lower Limit", this is signalled by the red and green LEDs lighting up. If the measured value is between the set "Higher Limit" and "Lower Limit", only the green LED lights up. If the "Higher Limit" value is also exceeded, only the red LED lights up.



Note:

This function is only available in the measuring modes RT, PK and Save. If the "Stop Force" function is activated, no LED or only the green LED will light up, depending on the setting.

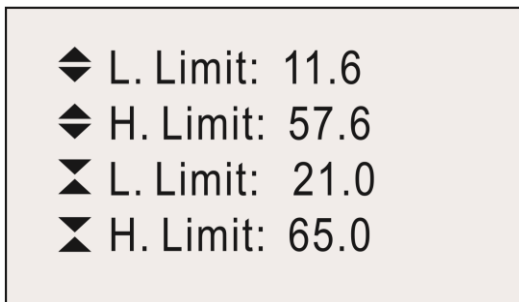

To set the alarm limits, press the **SET** key in the current measuring mode.



Display	Meaning
	This setting refers to tensile force
	This setting refers to compressive force
L. Limit	Lower Limit. Here you set the first limit value. This value cannot be higher than the H. Limit value.
H. Limit	Higher Limit. Here you set the second limit value. This value cannot be smaller than the L. Limit value.
Number	Here you set the desired limit.



Use the arrow keys to select the desired parameter. Now press the **DIR ENTER** key to make changes to this value. You can now use the arrow keys to change the value as desired. Confirm



the entry with the **DIR ENTER** key. Press the **ESC >0<** key to return to the measuring mode.

Note:

The second limit value must always be higher than the first set limit value. The set values are



shown above the display in measuring mode. Pressing the **DIR ENTER** key selects between the display of the set alarm tension or the set alarm compression.

10 Rotate display

SET

To rotate the display, press and hold the **SET** key in the current measuring mode. Then release the key. The display will rotate by 180 °.

11 Communication interface and output interface

With this force gauge, the saved measurement data can be transferred to a PC. To do this,

SET

connect the USB cable to the meter and to the PC. To activate this function, first press the

DIR
ENTER

key four times. Now select the "Online" function with the arrow keys. Now press the **DIR ENTER** key. With the arrow keys, you can now change the setting from „OFF“ to “ON”. Now confirm your entry

DIR
ENTER

with the **DIR ENTER** key. The USB interface is now activated with this setting.



P. M. C. F: 1.0
Shutoff: 15 min
Backlight: ON
Online: ON

After installing the drivers and the software, you can establish a serial connection to the force gauge via the software. To do so, set the parameters of the force gauge under "Serial Port Setting". Now use the "OPEN" button to establish a connection. The force gauge has a memory for the peak values and a memory for the average values.

To read out the memory for the peak values, type a "P" into the text field of the software and then click on "Send". The memory content is then displayed below the software. If you want to read out the memory for the average values, type "A" into the text field and click on "Send".

To remove the read data, click on "Clear".

You can also save the data to your PC permanently. To do this, click on the "SAVE" button. The data can be saved in ".xls" and ".txt" file format.

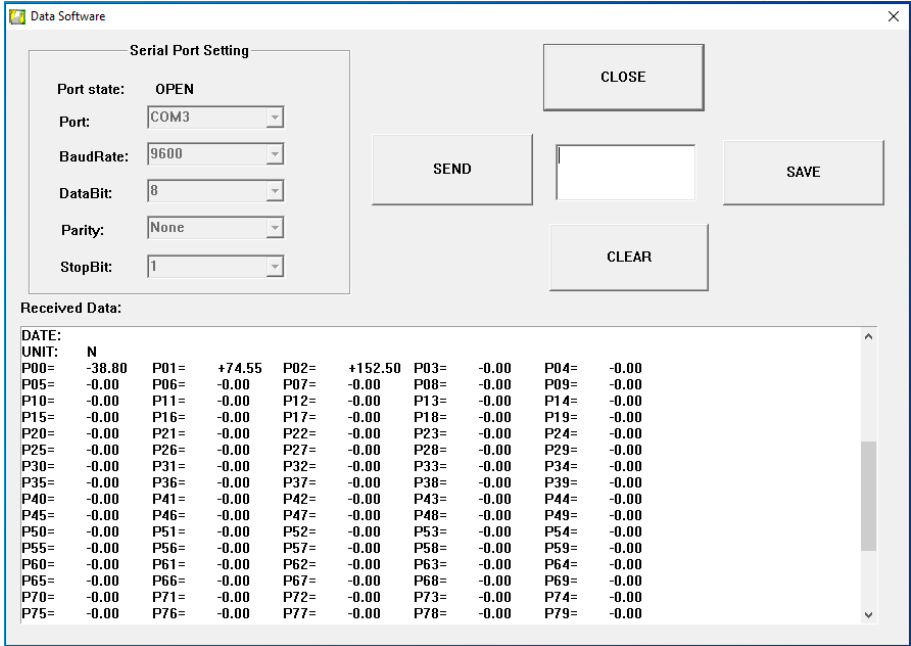

12 More settings

SET

To make further settings to the meter, press the **SET** key three times in measuring mode. Use the arrow keys to select your desired parameter. Once you have found your desired parameter,

DIR
ENTER

press the **DIR ENTER** key to select the function. Use the arrow keys again to make the changes.

DIR
ENTER

Confirm the entry with the **DIR ENTER** key.

St. Force: 28.8
Stop Mode: OFF
S. Point: 05
F. Point: 20

The displayed functions have the following meanings:

Function	Meaning
St. Force	Here you can set the limit weight at which a test stand is to stop.
Stop Mode	Here you can activate and deactivate the control of the test stand via the PCE-PFG.
S. Point	This is the starting point where data recording is to begin.
F. Point	This is the end point at which data recording is to be stopped.

SET

The **SET** key must be pressed again for the following functions.

P. M. C. F: 1.0
 Shutoff: 15 min
 Backlight: ON
 Online: ON

Function	Meaning
P.M.C.F	Here you set the minimum load for the measuring mode "SAVE MODE" to save a peak value.
Shutoff	Here you can select when the force gauge switches itself off. Selectable range: 0 ... 30 min. Selecting 0 minutes switches off this function. The force gauge is then permanently switched on.
Backlight	Here you can switch the backlight on and off.
Online	This activates the data interface.

ESC
 →0←

To exit the menu again, press the **ESC** key.

12.1 Product information

To inform you about the serial number, product name and version number, this is displayed each time the meter is started.

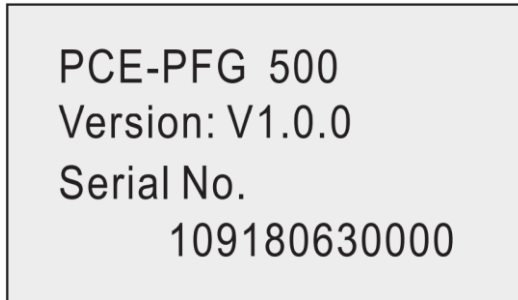

13 Contact

If you have any questions, suggestions or technical problems, please do not hesitate to contact us. You will find the relevant contact information at the end of this user manual.

14 Disposal

For the disposal of batteries in the EU, the 2006/66/EC directive of the European Parliament applies. Due to the contained pollutants, batteries must not be disposed of as household waste. They must be given to collection points designed for that purpose.

In order to comply with the EU directive 2012/19/EU we take our devices back. We either reuse them or give them to a recycling company which disposes of the devices in line with law.

For countries outside the EU, batteries and devices should be disposed of in accordance with your local waste regulations.

If you have any questions, please contact PCE Instruments.





PCE Instruments contact information

Germany

PCE Deutschland GmbH
Im Langel 4
D-59872 Meschede
Deutschland
Tel.: +49 (0) 2903 976 99 0
Fax: +49 (0) 2903 976 99 29
info@pce-instruments.com
www.pce-instruments.com/deutsch

United Kingdom

PCE Instruments UK Ltd
Unit 11 Southpoint Business Park
Ensign Way, Southampton
Hampshire
United Kingdom, SO31 4RF
Tel: +44 (0) 2380 98703 0
Fax: +44 (0) 2380 98703 9
info@pce-instruments.co.uk
www.pce-instruments.com/english

The Netherlands

PCE Brookhuis B.V.
Institutenweg 15
7521 PH Enschede
Nederland
Telefoon: +31 (0)53 737 01 92
info@pcebenelux.nl
www.pce-instruments.com/dutch

United States of America

PCE Americas Inc.
1201 Jupiter Park Drive, Suite 8
Jupiter / Palm Beach
33458 FL
USA
Tel: +1 (561) 320-9162
Fax: +1 (561) 320-9176
info@pce-americas.com
www.pce-instruments.com/us

France

PCE Instruments France EURL
23, rue de Strasbourg
67250 Soultz-Sous-Forets
France
Téléphone: +33 (0) 972 3537 17
Numéro de fax: +33 (0) 972 3537 18
info@pce-france.fr
www.pce-instruments.com/french

Italy

PCE Italia s.r.l.
Via Pesciatina 878 / B-Interno 6
55010 Loc. Gragnano
Capannori (Lucca)
Italia
Telefono: +39 0583 975 114
Fax: +39 0583 974 824
info@pce-italia.it
www.pce-instruments.com/italiano

China

PCE (Beijing) Technology Co., Limited
1519 Room, 6 Building
Zhong Ang Times Plaza
No. 9 Mentougou Road, Tou Gou District
102300 Beijing, China
Tel: +86 (10) 8893 9660
info@pce-instruments.cn
www.pce-instruments.cn

Spain

PCE Ibérica S.L.
Calle Mayor, 53
02500 Tobarra (Albacete)
España
Tel. : +34 967 543 548
Fax: +34 967 543 542
info@pce-iberica.es
www.pce-instruments.com/espanol

Turkey

PCE Teknik Cihazları Ltd.Şti.
Halkalı Merkez Mah.
Pehlivan Sok. No.6/C
34303 Küçükçekmece - İstanbul
Türkiye
Tel: 0212 471 11 47
Faks: 0212 705 53 93
info@pce- cihazlari.com.tr
www.pce-instruments.com/turkish

Hong Kong

PCE Instruments HK Ltd.
Unit J, 21/F., COS Centre
56 Tsun Yip Street
Kwun Tong
Kowloon, Hong Kong
Tel: +852-301-84912
jyi@pce-instruments.com
www.pce-instruments.cn