



# User Manual

PCE-TC 33N Thermal Imaging Camera



User manuals in various languages (français, italiano, español, português, nederlands, türk, polski, русский, 中文) can be found by using our product search on: [www.pce-instruments.com](http://www.pce-instruments.com)

Last change: 11 August 2021  
v1.0



## Contents

<b>1</b>	<b>Safety notes</b> .....	<b>1</b>
<b>2</b>	<b>Specifications</b> .....	<b>3</b>
2.1	Technical specifications .....	3
2.2	Delivery scope.....	4
<b>3</b>	<b>System description</b> .....	<b>5</b>
3.1	Device description .....	5
3.2	Control panel.....	6
3.3	Display description .....	7
3.4	Charge / replace battery .....	8
<b>4</b>	<b>Operation</b> .....	<b>9</b>
4.1	Switching the unit on and off .....	9
4.2	Functions in measuring mode .....	9
4.3	Submenus.....	10
4.4	Display / delete saved images .....	10
4.5	Colour palettee.....	11
4.6	Emissivity .....	12
4.7	Settings.....	13
<b>5</b>	<b>Troubleshooting</b> .....	<b>15</b>
<b>6</b>	<b>Maintenance</b> .....	<b>16</b>
6.1	Cleaning the meter.....	16
6.2	Cleaning the infrared lens.....	16
<b>7</b>	<b>Contact</b> .....	<b>16</b>
<b>8</b>	<b>Disposal</b> .....	<b>16</b>

## 1 Safety notes

Please read this manual carefully and completely before you use the device for the first time. The device may only be used by qualified personnel and repaired by PCE Instruments personnel. Damage or injuries caused by non-observance of the manual are excluded from our liability and not covered by our warranty.

- The device must only be used as described in this instruction manual. If used otherwise, this can cause dangerous situations for the user and damage to the meter.
- The instrument may only be used if the environmental conditions (temperature, relative humidity, ...) are within the ranges stated in the technical specifications. Do not expose the device to extreme temperatures, direct sunlight, extreme humidity or moisture.
- Do not expose the device to shocks or strong vibrations.
- The case should only be opened by qualified PCE Instruments personnel.
- Never use the instrument when your hands are wet.
- You must not make any technical changes to the device.
- The appliance should only be cleaned with a damp cloth. Use only pH-neutral cleaner, no abrasives or solvents.
- The device must only be used with accessories from PCE Instruments or equivalent.
- Before each use, inspect the case for visible damage. If any damage is visible, do not use the device.
- Do not use the instrument in explosive atmospheres.
- The measurement range as stated in the specifications must not be exceeded under any circumstances.
- Non-observance of the safety notes can cause damage to the device and injuries to the user.
- If smoke, sparks or a smell of burning occur during use, stop the use immediately. If possible, disconnect the power supply. After the smoke and smell have completely disappeared, contact PCE Instruments.



### Attention:

- When the meter is in operation, a slight clicking sound can be heard every few seconds. This is normal and means that the IR sensor is sensing the surroundings.
- Do not place the meter directly near a strong heat source.
- When charging, make sure that the correct adaptor is used. The adaptor plug may differ depending on your region. If the mains plug is incorrect, the instrument may overheat, electric shock, fire, chemical leakage from the battery or explosion of the device may occur.
- After charging, disconnect the charging cable from the socket and the device.
- If the meter comes into contact with a liquid, wipe it dry immediately. If the liquid enters the interior of the meter, switch off the power supply immediately. Further use may result in product damage.
  
- Problems due to water condensation  
If you use the instrument successively in areas with different ambient temperatures, condensation may form on the lens and sensor cover or inside the instrument. To avoid this, the instrument should be transported in its bag or a plastic bag. Allow it some time to reach ambient temperature before use. If condensation has formed inside the instrument, switch it off immediately. Otherwise, the meter may be damaged.
- Long-term storage  
The unit should be stored in a cool and dry place when not in use for a long period of time. The battery should be charged for two hours at least every three months to ensure that the meter is ready for use and that the battery life is not reduced.

We do not assume liability for printing errors or any other mistakes in this manual.

We expressly point to our general guarantee terms which can be found in our general terms of business.

If you have any questions please contact PCE Instruments. The contact details can be found at the end of this manual.

## 2 Specifications

### 2.1 Technical specifications

<b>Optical specifications</b>	
IR resolution	220 x 160 pixels
Wavelength	8 ... 14 $\mu$ m
Thermal sensitivity	70 mK
Frame rate	9 Hz
Field of view (FOV)	35 ° x 26 °
Focus	fixed focus
Smallest distance	0.15 m
Temperature range	-20 ... 300 °C / -4 ... 572 °F
Accuracy	$\pm 2$ °C / $\pm 2$ %
Calibration of the measurement	auto
Number of spots	1
Number of measurement ranges	1
Adjustable emissivity	0.01 ... 1.00
Colour palettes	spectrum, iron, cold, white, black
<b>Display</b>	
Picture in picture function (overlapping of infrared and visual image)	adjustable in steps of 25 %, 50 %, 75 %, 100%
Camera resolution of general camera	300,000 pixels
Display	3.2" TFT
Display resolution	320 x 240 pixels
<b>Memory</b>	
Image memory	fixed SD card, 3 GB, for more than 20,000 images
Image format	JPG
<b>Power supply</b>	
Battery	built-in rechargeable 18650 Li-ion battery approx. 2,800 mAh
Mains adaptor	primary: 100 ... 240 V AC, 50/60 Hz secondary: 5 V / 2 A DC
Operating time	2 ... 3 h
Automatic shutdown	20 min / 5 min / off
<b>Other specifications</b>	
Interface	micro USB for charging and for memory readout on a PC
Menu languages	English, Chinese, Italian, German
Operating conditions	0 ... 45 °C $\leq 85$ % RH (non-condensing)
Storage conditions	-20 ... 60 °C $\leq 85$ % RH (non-condensing)
Dimensions	90 x 103 x 223 mm / 3.5 x 4.1 x 8.8"
Weight	424 g / <1 lb



## **2.2 Delivery scope**

- 1 x thermal imaging camera PCE-TC 33N
- 1 x micro USB cable
- 1 x USB charging adaptor
- 1 x transport bag
- 1 x user manual

### 3 System description

#### 3.1 Device description

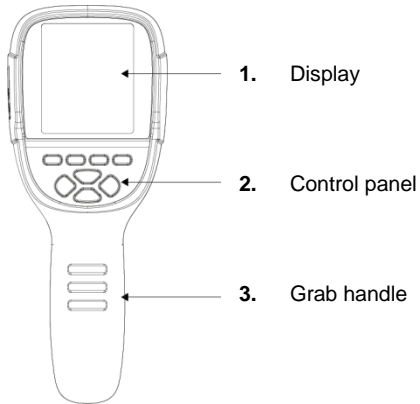

Figure 1 Rear side of the meter with display and control panel

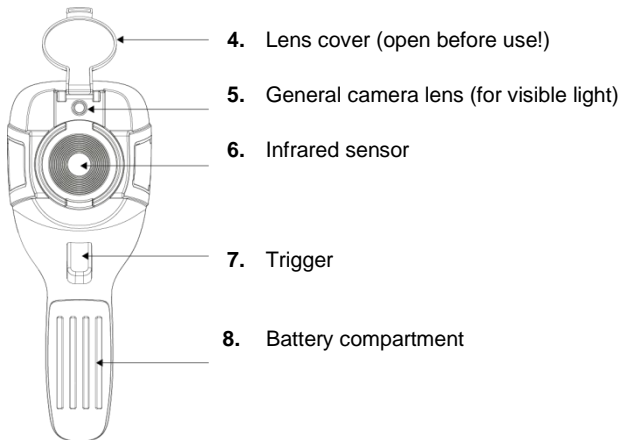
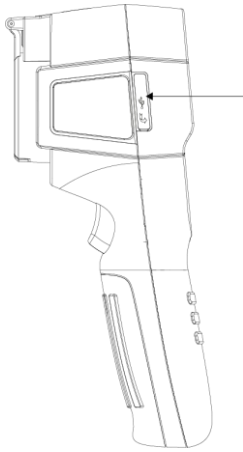

Figure 2 Front side of meter with trigger, general and IR lens



9. Micro USB connection under protective cap

Figure 3 Side view with USB connection

### 3.2 Control panel

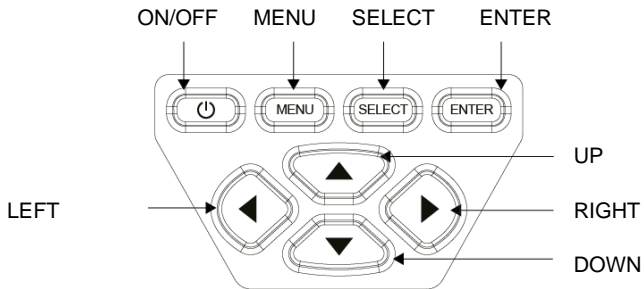
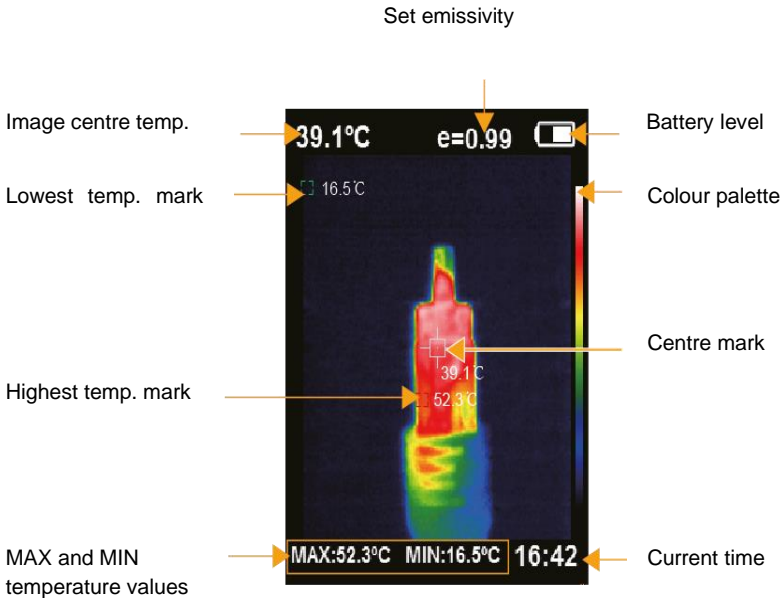

Figure 4 Control panel



### 3.3 Display description



#### Lowest temperature mark

The green mark appears where the lowest temperature is measured. The minimum measured temperature is also displayed in the middle of the bottom line as the MIN value.

#### Centre mark

The white mark appears in the centre of the image. The temperature in the centre of the image is also displayed in large size and as a numerical value at the top left.

#### Lowest temperature mark

The red mark appears where the highest temperature is measured. The maximum measured temperature is also displayed in the middle of the bottom line as the MAX value.

#### Colour palette

The colours of the selected colour palette are shown on the right edge of the display in a vertical strip. The colour for the lowest temperature is at the bottom.

#### MAX and MIN temperature value and time

At the bottom of the display, the MAX and MIN temperature values and the time can be hidden and shown by pressing the UP navigation key.



## 3.4 Charge / replace battery

### 3.4.1 Charge battery

The PCE-TC 33N thermal imaging camera has a built-in rechargeable Li-Ion battery. If the battery level is low, this is indicated by the battery status icon  at the top right of the display. In that case, charge the battery via the micro USB interface.

- Connect USB cable and mains adaptor.
- Plug the mains adaptor into an earthed socket.
- Open the protective cover on the camera and connect the micro USB plug to the interface.
- After charging, disconnect the cable from the camera and the socket.

During the charging process, the following icon  appears in the top right-hand corner of the display.

When the battery is fully charged, the  icon is displayed.

#### **Notes on charging:**

*Charge the battery for at least 1.5 hours before using the camera for the first time.*

*Before charging, make sure that the battery, charger and camera are at room temperature.*

*Charging at extreme temperatures can have a negative effect on the runtime and service life.*

*Do not charge the battery for more than 24 hours.*

*The battery should be charged for 2 hours at least every three months to avoid a reduced battery life.*

### 3.4.2 Replace battery

The battery compartment cover is fixed below the trigger and to the side but can be removed completely. To do this, press on it and push it down until the locks are released. Once you have removed the cover, you can remove the battery and insert a new one.

Make sure that the new battery is connected correctly.

Then push the battery cover back onto the camera's handle correctly.

## 4 Operation

### 4.1 Switching the unit on and off

Press and hold the ENTER key for more than 3 seconds to switch the thermal imaging camera on or off. After switching on, the lens cover must be opened. The display then shows the thermal image of the targeted area.

If you move the camera between environments with very different temperatures, it may take a while for the thermal image to update on the display.

#### **Note**

*Charge the battery for at least 1.5 hours before using the thermal imaging camera for the first time.*

The meter may start with an English menu the first time. To switch the language, see chapter 4.7.3

### 4.2 Functions in measuring mode

#### 4.2.1 Hiding and showing MAX and MIN temperature and time

The MAX and MIN temperature values and the time at the bottom of the display can be hidden and shown by pressing the UP navigation key.

#### 4.2.2 Picture in picture function, picture overlapping

The images of the infrared camera and the general camera can be overlapped step by step. This often makes it easier to correctly assign the measured values of the infrared image.

Pressing the RIGHT or LEFT navigation key increases or decreases the percentage of the general image (0%, 25%, 50%, 75%, 100%).

#### 4.2.3 Saving images

Press the trigger on the handgrip to save the currently displayed image.

A dialogue box appears: Save image? Yes / No.

Press the MENU key for Yes or SELECT for No.

#### **Note**

*If the camera is connected to a PC via USB cable, no new images can be saved. When the connection is active, the USB icon is displayed at the top of the display. After pressing the trigger, the message "Disc Occupy" appears at the bottom left.*

#### 4.2.4 Viewing / transferring images to a computer

You can view the saved images on your computer and transfer them to the computer.

Open the protective cover of the camera and connect the USB cable to the interfaces on the camera and computer.

The camera is recognised as a USB memory by the supported operating systems Windows XP, 7, 8, 10 and MacOS. The images stored in JPG format can be viewed, copied or deleted as with a USB stick.

Before disconnecting the USB cable, the "Safely remove hardware" function should be used so that no image data is lost.

## 4.3 Submenus

### 4.3.1 Image registration / Adjust IR image and general image

It may happen that the infrared image and the normal image on the display do not overlap completely. This can be corrected via the menu "Image registration".

Press the MENU key. A selection list of submenus appears.

The current function is highlighted in blue.

The selection can be changed with the navigation keys UP or DOWN.

Confirm the selection "Image registration" with the SELECT key.

- Four thick white directional arrows appear for a short time, starting from the centre of the image.
- As long as these arrows are displayed, you can move the general picture.
- Press and release RIGHT, LEFT, UP or DOWN briefly to move the image.

If no operation is performed for more than 6 seconds, the camera automatically switches back to measuring mode and the direction arrows disappear. If the images still do not overlap correctly, call up the function again.

### 4.4 Display / delete saved images

You can view and delete saved images via the "Image" submenu.

Press the MENU key. The current function is highlighted in blue.

The selection can be changed with the navigation keys UP or DOWN.

Confirm the selection of the "Image" function with the RIGHT navigation key.

A list of the saved images appears.

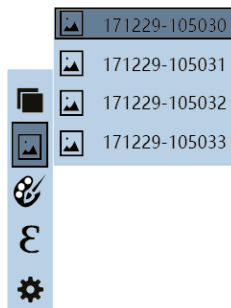

- Use the UP or DOWN key to select an image from the list.
- Confirm with SELECT or ENTER.
- The selected image is displayed and you can now
  - use the RIGHT or LEFT key to go directly to the next or previous image.
  - use the UP key to open the dialogue window "Delete image? Yes / No". Press MENU for "Yes" or SELECT for "No".
  - Press SELECT or ENTER to return to the list of saved images.

Now press

- LEFT to return to the list of submenus
- MENU to enter measuring mode

## 4.5 Colour palette

### 4.5.1 Description of the colour palettes

Different colour palettes can be used to display the temperature differences of the infrared image. The PCE-TC 33N offers five colour palettes common for thermographic images: spectrum (rainbow), iron, cold, white (hot), black (hot).

The coloured palettes work best with large temperature differences and provide additional coloured contrast. For some images, black and white images are nevertheless more suitable. Test on a case-by-case basis which colour palette offers the best representation.

Here the infrared images of a component are shown with the different colour palettes:



Spectrum

Iron

Cold

White

Black

### 4.5.2 Select colour palette

You can change the colour palette via the "Color palette" submenu.

Press the MENU key. The current function is highlighted in blue.

The selection can be changed with the navigation keys UP or DOWN.

Confirm the selection of the "Color palette" function with the RIGHT navigation key.

A list of colour palettes appears.

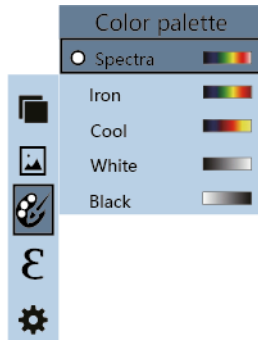

- Use UP / DOWN to select a colour palette.
- Confirm with SELECT.
- Press LEFT or ENTER to return to the menu list.
- Press MENU to enter measuring mode.

In measuring mode, the current colour palette is now applied. The right edge of the screen shows the selected scale. The colour for hot is always shown at the top.

## 4.6 Emissivity

### 4.6.1 Description of the emissivity

Every object with a temperature above absolute zero emits thermal radiation. The emissivity is the indicator of how much thermal radiation this object emits in contrast to an ideal thermal radiator, the black body. The emissivity is therefore always between 0 ... 1 (0 ... 100 %). For many applications, it is sufficient to measure with the standard value of 0.95. For a correct temperature measurement, however, it is essential to take the correct emissivity of the surface to be measured into account.

### 4.6.2 Set emissivity

You can change the emissivity via the submenu "Emissivity".

Press the MENU key. The current function is highlighted in blue.

The selection can be changed with the navigation keys UP or DOWN.

Confirm the selection of the "Emissivity" function with the RIGHT navigation key.

A list of the selectable emissivities appears.

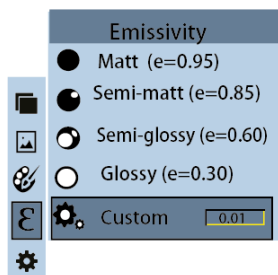

- Matt (0.95)
- Semi-matt (0.85)
- Semi-glossy (0.60)
- Glossy (0.30)
- Custom

Set the value to match the surface of the depicted object.

- Press UP / DOWN to select the desired emissivity.
- Confirm with SELECT. The selection is marked with a small circle.
- If you select "Custom", the field will turn grey and you can enter values from 0.01 to 1.00.
  - Press RIGHT or LEFT to change the digit position.
  - Press UP or DOWN to change the digit value.
  - Confirm with ENTER.
- Press LEFT or ENTER to return to the menu list.
- Press MENU to enter measuring mode.

The current emissivity is now used in measuring mode. The emissivity is displayed at the top of the display, for example  $e = 0.95$ .

#### 4.6.3 Emissivities of common materials

Material	Thermal emissivity	Material	Thermal emissivity
Bitumen	0.90 ... 0.98	Black cloth	0.98
Concrete	0.94	Human skin	0.98
Cement	0.96	Foam	0.75 ... 0.80
Sand	0.90	Charcoal dust	0.96
Earth	0.92 ... 0.96	Paint	0.80 ... 0.95
Water	0.92 ... 0.96	Matte paint	0.97
Ice	0.96 ... 0.98	Black rubber	0.94
Snow	0.83	Plastic	0.85 ... 0.95
Glass	0.90 ... 0.95	Timber	0.90
Ceramics	0.90 ... 0.94	Paper	0.70 ... 0.94
Marble	0.94	Chromium hemitrioxide	0.81
Gypsum	0.80 ... 0.90	Copper oxide	0.78
Mortar	0.89 ... 0.91	Ferric oxide	0.78 ... 0.82
Brick	0.93 ... 0.96	Textiles	0.90

#### 4.7 Settings







You can adjust various device settings via the "Settings" submenu.

Press the MENU key. The current function is highlighted in blue.

The selection can be changed with the navigation keys UP or DOWN.

Confirm the selection of the "Settings" function with the RIGHT navigation key.

A list of possible settings appears. Select from it with UP or DOWN.

Settings			
 ►	Auto shutdown		NO 5 min 20 min
 ►	Intensity	Image contrast / brightness	Low Medium High
 ►	Language		English Chinese Italian German
 ►	Unit	Temperature unit	Celsius Fahrenheit
 ►	Time format	Time indication 12h or 24h format	24 hour AM/PM
 ►	Set time	Set date and time	Year Month Day Hour Minute Second
 ►	Spot	MIN / MAX temperature mark	Off On



#### **4.7.1 Auto shutdown**

Confirm the selection of the "Auto shutdown" function with the RIGHT navigation key. A selection list appears.

- Select with UP / DOWN.
- Confirm with SELECT. The selection is marked with a small circle.
- Press LEFT or ENTER to return to the "Settings" menu.
- Press MENU to enter measuring mode.

#### **4.7.2 Intensity**

Confirm the selection of the "Intensity" function with the RIGHT navigation key. A selection list appears.

- Select with UP / DOWN.
- Confirm with SELECT. The selection is marked with a small circle.
- Press LEFT or ENTER to return to the "Settings" menu.
- Press MENU to enter measuring mode.

#### **4.7.3 Language**

Confirm the selection of the "Language" function with the RIGHT navigation key. A selection list appears.

- Select with UP / DOWN.
- Confirm with SELECT. The selection is marked with a small circle.
- Press LEFT or ENTER to return to the "Settings" menu.
- Press MENU to enter measuring mode.

#### **4.7.4 Temperature unit**

Confirm the selection of the "Unit" function with the RIGHT navigation key. A selection list appears.

- Select with UP / DOWN.
- Confirm with SELECT. The selection is marked with a small circle.
- Press LEFT or ENTER to return to the "Settings" menu.
- Press MENU to enter measuring mode.

#### **4.7.5 Time format**

Confirm the selection of the "Time format" function with the RIGHT navigation key. A selection list appears.

- Select with UP / DOWN.
- Confirm with SELECT. The selection is marked with a small circle.
- Press LEFT or ENTER to return to the "Settings" menu.
- Press MENU to enter measuring mode.



#### 4.7.6 Set time

Confirm the selection of the "Set time" function with the RIGHT navigation key. A list appears.

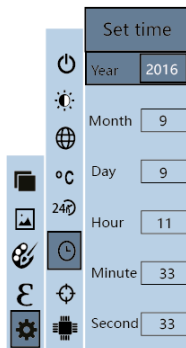

- Select the value to be changed with UP / DOWN.
- Confirm with SELECT.
  - The field turns grey and you can change the numerical value.
    - Press RIGHT or LEFT to change the digit position.
    - Press UP or DOWN to change the digit value.
    - Confirm with ENTER.
- Press LEFT or ENTER to return to the "Settings" menu.
- Press MENU to enter measuring mode.

#### 4.7.7 Spot / marker for the MIN and MAX temperature in the image

Confirm the selection of the "Spot" function with the RIGHT navigation key. A selection list appears.

- Select with UP / DOWN.
- Confirm with SELECT. The selection is marked with a small circle.
- Press LEFT or ENTER to return to the "Settings" menu.
- Press MENU to enter measuring mode.

## 5 Troubleshooting

If you have any problems with the thermal imaging camera, first look at the table below. If the suggested solutions do not help you, contact our technical support.

Problem	Possible cause	Solution
Thermal imaging camera cannot be started	No battery inserted	Insert battery.
	Battery flat	Replace or charge the battery.
Thermal imaging camera switches off during operation	Battery flat	Replace or charge the battery.
	The time set for automatic shutdown has been reached.	Restart.
No thermal image	The protective cover is not open.	Open the lens cover.

## 6 Maintenance

### 6.1 Cleaning the meter

Use a slightly damp lint-free cloth and only gentle cleaning agents. Do not use abrasive agents or strong solvents for cleaning. If necessary, the lenses and the screen should be cleaned with special cleaning agents for optical glass.

### 6.2 Cleaning the infrared lens

Prevent damage to the infrared lens when cleaning it. The lens has a high-quality anti-reflective coating. Therefore, clean the lens carefully and without applying strong pressure to avoid damaging the anti-reflective coating. To clean the lens, use a special cleaning solution, e. g. customary alcohol-based lens cleaner and a lint-free textile or paper towel.

Dampen the lint-free cloth or towel with the cleaning solution. Remove excess liquid by squeezing the cloth or by absorbing it through an additional dry cloth. Then wipe the lens surface with circular movements. If it is necessary to repeat this step, use a new cloth.

## 7 Contact

If you have any questions, suggestions or technical problems, please do not hesitate to contact us. You will find the relevant contact information at the end of this user manual.

## 8 Disposal

For the disposal of batteries in the EU, the 2006/66/EC directive of the European Parliament applies. Due to the contained pollutants, batteries must not be disposed of as household waste. They must be given to collection points designed for that purpose.

In order to comply with the EU directive 2012/19/EU we take our devices back. We either re-use them or give them to a recycling company which disposes of the devices in line with law.

For countries outside the EU, batteries and devices should be disposed of in accordance with your local waste regulations.

If you have any questions, please contact PCE Instruments.



## PCE Instruments contact information

### Germany

PCE Deutschland GmbH  
Im Langel 4  
D-59872 Meschede  
Deutschland  
Tel.: +49 (0) 2903 976 99 0  
Fax: +49 (0) 2903 976 99 29  
info@pce-instruments.com  
www.pce-instruments.com/deutsch

### United Kingdom

PCE Instruments UK Ltd  
Unit 11 Southpoint Business Park  
Ensign Way, Southampton  
Hampshire  
United Kingdom, SO31 4RF  
Tel: +44 (0) 2380 98703 0  
Fax: +44 (0) 2380 98703 9  
info@pce-instruments.co.uk  
www.pce-instruments.com/english

### The Netherlands

PCE Brookhuis B.V.  
Institutenweg 15  
7521 PH Enschede  
Nederland  
Telefoon: +31 (0)53 737 01 92  
info@pcebenelux.nl  
www.pce-instruments.com/dutch

### France

PCE Instruments France EURL  
23, rue de Strasbourg  
67250 Soultz-Sous-Forets  
France  
Téléphone: +33 (0) 972 3537 17  
Numéro de fax: +33 (0) 972 3537 18  
info@pce-france.fr  
www.pce-instruments.com/french

### Italy

PCE Italia s.r.l.  
Via Pesciatina 878 / B-Interno 6  
55010 Loc. Gragnano  
Capannori (Lucca)  
Italia  
Telefono: +39 0583 975 114  
Fax: +39 0583 974 824  
info@pce-italia.it  
www.pce-instruments.com/italiano

### Hong Kong

PCE Instruments HK Ltd.  
Unit J, 21/F., COS Centre  
56 Tsun Yip Street  
Kwun Tong  
Kowloon, Hong Kong  
Tel: +852-301-84912  
jyi@pce-instruments.com  
www.pce-instruments.cn

### Spain

PCE Ibérica S.L.  
Calle Mayor, 53  
02500 Tobarra (Albacete)  
España  
Tel. : +34 967 543 548  
Fax: +34 967 543 542  
info@pce-iberica.es  
www.pce-instruments.com/espanol

### Turkey

PCE Teknik Cihazları Ltd.Şti.  
Halkalı Merkez Mah.  
Pehlivan Sok. No.6/C  
34303 Küçükçekmece - İstanbul  
Türkiye  
Tel: 0212 471 11 47  
Faks: 0212 705 53 93  
info@pce-cihazlari.com.tr  
www.pce-instruments.com/turkish

### United States of America

PCE Americas Inc.  
1201 Jupiter Park Drive, Suite 8  
Jupiter / Palm Beach  
33458 FL  
USA  
Tel: +1 (561) 320-9162  
Fax: +1 (561) 320-9176  
info@pce-americas.com