



User Manual

PCE-VE 400N4 / PCE-VE 800N4 / PCE-VE 900N4 Industrial Borescope



User manuals in various languages (français, italiano, español, português, nederlands, türk, polski, русский, 中文) can be found by using our product search on: www.pce-instruments.com

Last change: 13 January 2021
v1.0



Contents

1	Safety notes	1
2	Specifications	2
3	Delivery scope	2
4	Device description	3
5	Function modes	4
5.1	Key assignment	4
5.2	Display icons	5
5.3	Switch the instrument on/off	5
5.4	Menu	5
6	Rechargeable batteries	6
6.1	Remove batteries	6
6.2	External charging	6
7	Contact	7
8	Disposal	7

1 Safety notes

Please read this manual carefully and completely before you use the device for the first time. The device may only be used by qualified personnel and repaired by PCE Instruments personnel. Damage or injuries caused by non-observance of the manual are excluded from our liability and not covered by our warranty.

- The device must only be used as described in this instruction manual. If used otherwise, this can cause dangerous situations for the user and damage to the meter.
- The instrument may only be used if the environmental conditions (temperature, relative humidity, ...) are within the ranges stated in the technical specifications. Do not expose the device to extreme temperatures, direct sunlight, extreme humidity or moisture.
- Do not expose the device to shocks or strong vibrations.
- The case should only be opened by qualified PCE Instruments personnel.
- Never use the instrument when your hands are wet.
- You must not make any technical changes to the device.
- The appliance should only be cleaned with a damp cloth. Use only pH-neutral cleaner, no abrasives or solvents.
- The device must only be used with accessories from PCE Instruments or equivalent.
- Before each use, inspect the case for visible damage. If any damage is visible, do not use the device.
- Do not use the instrument in explosive atmospheres.
- The measurement range as stated in the specifications must not be exceeded under any circumstances.
- Non-observance of the safety notes can cause damage to the device and injuries to the user.

We do not assume liability for printing errors or any other mistakes in this manual.

We expressly point to our general guarantee terms which can be found in our general terms of business.

If you have any questions please contact PCE Instruments. The contact details can be found at the end of this manual.



2 Specifications

Technical data of the endoscope PCE-VE 800N4		PCE-VE 400N4	PCE-VE 900N4
Cable / head diameter	2.8 mm	4 mm	2 mm
Camera head movement direction	4-way		
Camera head length	8 mm	18 mm	7 mm
Bending radius	7 mm	8 mm	6 mm
Camera head material	Titanium alloy		
Camera lens material	Glass		
Viewing angle	80 °	90 °	80 °
Viewing direction	0 °		
Focus area	5 ... 50 mm	10 ... 100 mm	3 ... 30 mm
Image sensor	1/18" colour	1/9" colour	1/18" colour
Resolution	160000 pixels	1000000 pixels	160000 pixels
Frame rate	30 Hz		
Length borescope cable	1.5 m		1.2 m
Material borescope cable	Tungsten		
Protection class borescope cable	IP58	IP67	IP58
Operating conditions	Main unit: 0 ... 45 °C / 15 ... 90 % RH Cable: 0 ... 60 °C		
Display	5" 16:9 LCD		
Interface	Micro USB		
Video output	HDMI		
Memory	SDHC memory card up to 64 GB		
Power supply	Li-Ion battery 3350 mAh Mains adaptor 5 V		
Dimensions	33.5 x 14.5 x 8 cm		
Weight	approx. 700 g		

3 Delivery scope

1x borescope PCE-VE 800N4 / PCE-VE 400N4 / PCE-VE 900N4

1x mains adaptor incl. charger

1x card reader

1x memory card

2x Li-Ion battery set

1x HDMI cable

1x cleaning set

1x user manual

1x carrying case

4 Device description

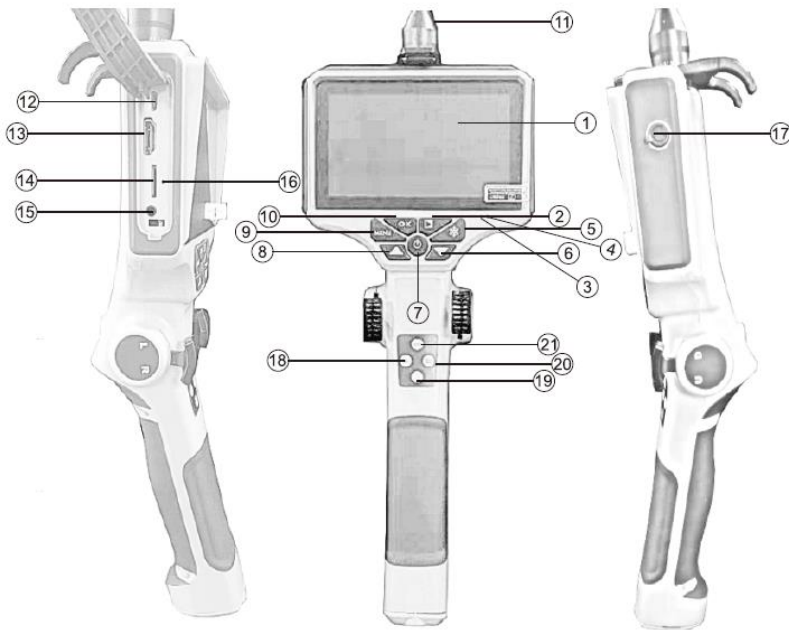











1. Display
2. Image memory
3. Charging indicator
4. Operating display
5. Freeze key (freeze image)
6. DOWN key
7. ON/OFF key
8. UP key
9. Menu key
10. OK key
11. Borescope cable
12. Micro USB socket (data transfer to PC)
13. HDMI socket (e. g. for external monitor)
14. SD card slot
15. Charging socket DC in
16. Reset key
17. Headphone jack
18. Video recording key
19. Illumination key
20. Image capture key
21. Display brightness

5 Function modes

The keys have different functions depending on which mode you are in. These are the 4 different modes you can be in:











Mode	Function
Recording	Display shows camera image and optional setting options.
Playback	Images and videos on the microSD card are displayed.
Toolbar	The toolbar is visible at the top of the screen in recording mode. Settings such as brightness, zoom, etc. can be changed here.
Menu	Contains all system settings.

5.1 Key assignment

Key	Recording	Playback	Toolbar	Menu
 Up/Down	-	Switch to previous / next image	Change the setting or option	Previous / next menu item
 Menu	Open menu	Open menu	Open menu	-
 Ok	Move to the next setting in the toolbar	Confirm deletion	Change in the settings	Confirm selection
 Play	Open record memory	Back to recording mode	Open record memory	-
 Freeze	Freeze image	Delete record	Freeze image	Back to recording mode
 Off/On	Switch off the instrument	Switch off the instrument	Switch off the instrument	Switch off the instrument
 LED	Adjust the brightness of the LED	-	Adjust the brightness of the LED	
 Video	Start/stop video recording	-	Start/stop video recording	-
 Image	Image recording	-	Image recording	-
 Brightness	Image brightness	-	Image brightness	-

Note: "-" means no function of the key in the respective function mode.

5.2 Display icons

Icon	Description
	Brightness (5 levels)
	Exposure (-2, -1, 0, +1, +2)
	Image rotation 90
	Colour filter (black and white, negative)
	White balance
	Freeze image
	Full screen
	Zoom
	Borescope is ready for image recording
	Borescope records a video

5.3 Switch the instrument on/off

Press and hold the off/on key for about 2 seconds to switch the instrument on or off.

5.4 Menu

In recording mode, press the menu key once to open the menu. Use the up/down keys to select the desired setting parameter. You can close the menu with the freeze key. The menu contains the following system settings:

5.4.1 Language

Here you can choose between German, English, Chinese and Japanese. Confirm your setting with the OK key.

5.4.2 Date/time

Setting the date and time and the display format - Press the freeze key to go to the next setting option. Confirm your entry with the Ok key.

5.4.3 Save power

Here you can set when the instrument should switch off automatically. You can select Off, 1 min, 3 min and 5 min. Confirm your setting with the OK key.

5.4.4 Print date

You can set whether only the date, date and time or nothing is saved on the image. Confirm your setting with the OK key.



5.4.5 Format

Here you can format the microSD card in the borescope. All data on the card will be irrevocably deleted. Confirm your setting with the OK key.

5.4.6 Reset everything

To reset the instruments to factory settings, select "Yes" in this menu item. Selecting "No" takes you back to the menu. If the instrument can no longer be operated, you can also use the reset key on the side of the instrument.

5.4.7 FW update

If a firmware update is available for the instrument, it can be installed via this menu item.

6 Rechargeable batteries

The batteries can be charged within the unit with the supplied mains adaptor, as well as with the external charger when removed.

6.1 Remove batteries

To remove the batteries, proceed as follows:

1. Loosen the screw of the bottom cover of the instrument.
2. Pull the battery unit out of the borescope.
3. Open the battery compartment by pulling off the cover.
4. Replace the batteries and reassemble the unit in reverse order. Make sure that the polarity is correct!



6.2 External charging

After removing the batteries from the instrument, place them in the charger. Make sure that the polarity is correct! As soon as the batteries are fully charged, you can re-insert them into the instrument.

Note: The batteries need approx. 8 hours to fully charge.

7 Contact

If you have any questions, suggestions or technical problems, please do not hesitate to contact us. You will find the relevant contact information at the end of this user manual.

8 Disposal

For the disposal of batteries in the EU, the 2006/66/EC directive of the European Parliament applies. Due to the contained pollutants, batteries must not be disposed of as household waste. They must be given to collection points designed for that purpose.

In order to comply with the EU directive 2012/19/EU we take our devices back. We either re-use them or give them to a recycling company which disposes of the devices in line with law.

For countries outside the EU, batteries and devices should be disposed of in accordance with your local waste regulations.

If you have any questions, please contact PCE Instruments.





PCE Instruments contact information

Germany

PCE Deutschland GmbH
Im Langel 4
D-59872 Meschede
Deutschland
Tel.: +49 (0) 2903 976 99 0
Fax: +49 (0) 2903 976 99 29
info@pce-instruments.com
www.pce-instruments.com/deutsch

United Kingdom

PCE Instruments UK Ltd
Unit 11 Southpoint Business Park
Ensign Way, Southampton
Hampshire
United Kingdom, SO31 4RF
Tel: +44 (0) 2380 98703 0
Fax: +44 (0) 2380 98703 9
info@pce-instruments.co.uk
www.pce-instruments.com/english

The Netherlands

PCE Brookhuis B.V.
Institutenweg 15
7521 PH Enschede
Nederland
Telefoon: +31 (0)53 737 01 92
info@pcebenelux.nl
www.pce-instruments.com/dutch

United States of America

PCE Americas Inc.
1201 Jupiter Park Drive, Suite 8
Jupiter / Palm Beach
33458 FL
USA
Tel: +1 (561) 320-9162
Fax: +1 (561) 320-9176
info@pce-americas.com
www.pce-instruments.com/us

France

PCE Instruments France EURL
23, rue de Strasbourg
67250 Soultz-Sous-Forêts
France
Téléphone: +33 (0) 972 3537 17
Numéro de fax: +33 (0) 972 3537 18
info@pce-france.fr
www.pce-instruments.com/french

Italy

PCE Italia s.r.l.
Via Pesciatina 878 / B-Interno 6
55010 Loc. Gragnano
Capannori (Lucca)
Italia
Telefono: +39 0583 975 114
Fax: +39 0583 974 824
info@pce-italia.it
www.pce-instruments.com/italiano

China

PCE (Beijing) Technology Co., Limited
1519 Room, 6 Building
Zhong Ang Times Plaza
No. 9 Mentougou Road, Tou Gou District
102300 Beijing, China
Tel: +86 (10) 8893 9660
info@pce-instruments.cn
www.pce-instruments.cn

Spain

PCE Ibérica S.L.
Calle Mayor, 53
02500 Tobarra (Albacete)
España
Tel. : +34 967 543 548
Fax: +34 967 543 542
info@pce-iberica.es
www.pce-instruments.com/espanol

Turkey

PCE Teknik Cihazları Ltd.Şti.
Halkalı Merkez Mah.
Pehlivan Sok. No.6/C
34303 Küçükçekmece - İstanbul
Türkiye
Tel: 0212 471 11 47
Faks: 0212 705 53 93
info@pce- cihazlari.com.tr
www.pce-instruments.com/turkish

Hong Kong

PCE Instruments HK Ltd.
Unit J, 21/F., COS Centre
56 Tsun Yip Street
Kwun Tong
Kowloon, Hong Kong
Tel: +852-301-84912
jyi@pce-instruments.com
www.pce-instruments.cn