



User Manual

PCE-DPM 3 Dew Point Thermometer



User manuals in various languages (français, italiano, español, português, nederlands, türk, polski, русский, 中文) can be found by using our product search on: www.pce-instruments.com

Last change: 6 October 2020
v1.0



Contents

1	Safety notes	1
2	Specifications	2
3	Device description	3
3.1	Keyboard description.....	4
4	Measurement window	4
5	Main menu and symbols	5
5.1	Functions	5
5.2	Recording function	6
5.3	Display settings	7
5.4	Environmental parameters/ measurement settings	8
5.5	Further settings	9
6	Contact	10
7	Disposal	10

1 Safety notes

Please read this manual carefully and completely before you use the device for the first time. The device may only be used by qualified personnel and repaired by PCE Instruments personnel. Damage or injuries caused by non-observance of the manual are excluded from our liability and not covered by our warranty.

- The device must only be used as described in this instruction manual. If used otherwise, this can cause dangerous situations for the user and damage to the meter.
- The instrument may only be used if the environmental conditions (temperature, relative humidity, ...) are within the ranges stated in the technical specifications. Do not expose the device to extreme temperatures, direct sunlight, extreme humidity or moisture.
- Do not expose the device to shocks or strong vibrations.
- The case should only be opened by qualified PCE Instruments personnel.
- Never use the instrument when your hands are wet.
- You must not make any technical changes to the device.
- The appliance should only be cleaned with a damp cloth. Use only pH-neutral cleaner, no abrasives or solvents.
- The device must only be used with accessories from PCE Instruments or equivalent.
- Before each use, inspect the case for visible damage. If any damage is visible, do not use the device.
- Do not use the instrument in explosive atmospheres.
- The measurement range as stated in the specifications must not be exceeded under any circumstances.
- Non-observance of the safety notes can cause damage to the device and injuries to the user.

We do not assume liability for printing errors or any other mistakes in this manual.

We expressly point to our general guarantee terms which can be found in our general terms of business.

If you have any questions please contact PCE Instruments. The contact details can be found at the end of this manual.

2 Specifications

Function	Measurement range	Resolution	Accuracy at 20 °C / 68 °F
Temperature	-10 ... 60 °C (+14 ... 140 °F)	0.01 °C (0.018 °F)	-10 ... 50 °C: ±0.3 °C (+14 ... 122 °F: ±0.54 °F)
Relative humidity	0 ... 100 %	0.01 %	<5 %: ±(0.025 % + 17.5 % of VAT) >5 %: ±(1 % + 5 % of VAT) >15 %: ±(2 % + 3 % of VAT)
Dew point	-50 ... 30 °C (-58 ... 86 °F)	0.01 °C (0.018 °F)	-40 ... 20 °C: ±2 °C -50 ... -40 °C ±2.5 °C
H2O	40 ... 20.000 ppm	1 ppm	±(7.3 ppm + 8.3 %)
The accuracy of the dew point is based on an ambient temperature of 16 ... 25 °C / 61 ... 77°F			
Further specifications			
Environmental conditions		-10 ... 60 °C (14 ... 140 °F) 0 ... 20 bar (absolute)	
Response time at: 0.2 m/s, 1 bar, 20 °C (68 °F), 63 % RH [90 %].		0 ... 40 °C (-40 ... 32 °F): 20 s [120 s] -40 ... 0 °C (-40 ... 32 °F): 10 s [20 s]	
Data memory		for approx. 50.000 measuring points	
Adjustable storage rates		10 seconds 1, 5, 10, 20, minutes	
Adjustable recording time		1, 5, 12, 24, 48 hours	
File format		CSV	
Cable length		approx. 1.5 m	
Thread		G1/2 "	
Thread length		1.2 cm	
Probe length		5.2 cm	
Probe width		1.2 cm	
Display		Ø5.9 cm LCD	
Power supply - battery		3.7 V, 3000 mAh	
Power supply – mains adaptor		Primary: 100 ... 240 VAC, 0.25 A Secondary: 5 VDC, 1 A	
Interface / mains connection		via micro USB	
Weight		approx. 610 g	

3 Device description

No.	Description
1	Display
2	Back key
3	On/off switch, hold key
4	Arrow left key
5	Interface 1 (no function)
6	Micro USB interface
7	Enter key
8	Arrow up key
9	Arrow right key
10	Arrow down key
11	Interface 2 for connecting the probe
12	G1/2" connection thread
13	Handle of the probe

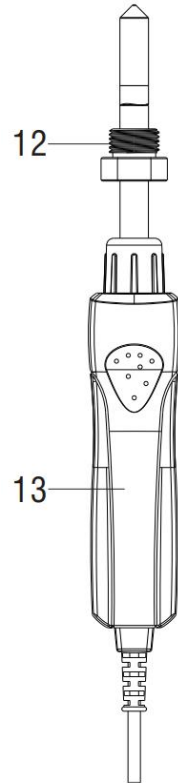
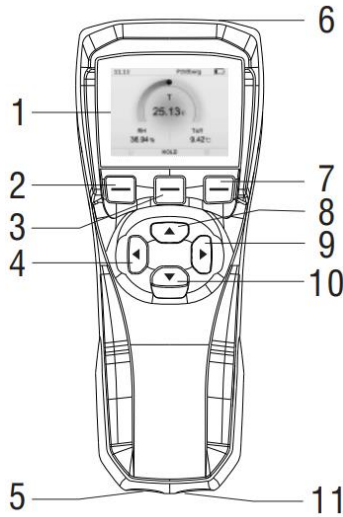

3.1 Keyboard description

No.	Description	Function
1	Back key	Go back one menu level
2	On/off switch, hold key	Press and hold the key to switch the meter on and off. Press the key briefly once to freeze the display.
3	Arrow keys up and down	Navigating in the menu / changing parameters
4	Enter key	Confirming an entry / entering the menu
5	Arrow keys left and right	Navigating in the menu / changing parameters

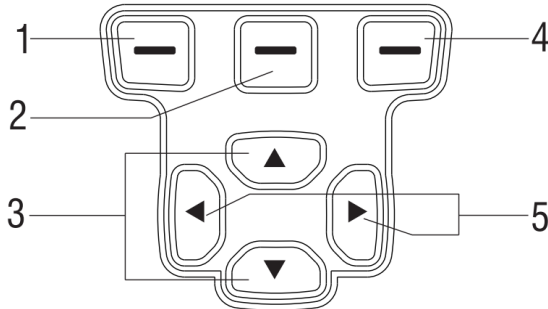

4 Measurement window



Use the arrow keys to change the appearance of the measurement window. Two different versions are available.

In addition, you can hold the currently displayed values with the hold key and save them with the enter key (4) according to your preference. To exit hold mode, press the back key (1). Then press the back key (1) to view the saved values in the measurement window.

5 Main menu and symbols

Open the main menu by pressing the enter key.

Select the desired menu symbol with the left and right keys or return with the left function key.



5.1 Functions

In the "Functions" setting on the left, you can make changes to the alarm functions. Select the item "Setting" with the left or right key.

Alarm settings: Select between Td/f (dew point), T (temperature) or RH (relative humidity) with the enter key.

Setting the upper limit value:

Use the arrow down key to select the item "High Limit" and then press the enter key. Now you can enter a value with the up and down keys and confirm it by pressing the enter key again.

Setting the lower limit value:

Use the arrow down key to go to the item "Low Limit" and then press the enter key. Now you can enter a value with the up and down keys and confirm it by pressing the enter key again.

Alarm on/off:

Use the arrow keys to select On/Off and press the enter key to activate the alarm. If the measured value exceeds the high limit value or falls below the low limit value, the bell symbol appears at the top and an acoustic signal can be heard. Press the enter key again to deactivate the alarm.





Connect computer:

Select this item if you want to transfer the data to a computer. Do not leave this menu item during the transfer. The data is displayed in an Excel chart.

5.2 Recording function

To save the data of the measuring device, select the menu item "Recording" with the left or right arrow key. Now you can activate or deactivate data saving with the enter key.

Recording interval ("Record gap"): 10 s, 1 min, 5 min, 20 min selectable

Record Time: 1 hour, 5 hours, 10 hours, 12 hours, 24 hours, 48 hours

The meter can save up to 32 files. One file contains 1000 data records. The capacity is therefore $32 \times 1000 = 32000$ records.

Note: If it is necessary to record for more than 6 hours, it is recommended to connect the instrument to a power supply to prevent power-related failure of the instrument.

The recorded data is saved in CSV format and can therefore be easily opened on a terminal device with Excel.

Attention: Make sure to save the data to your computer.

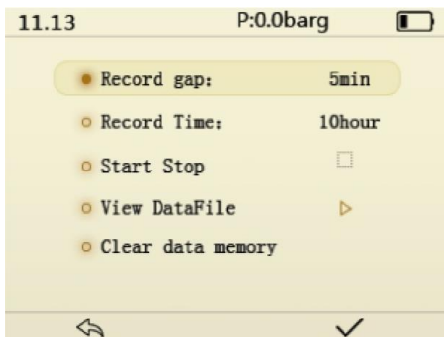

Display data: By means of the menu item "View DataFile", you can open and display the CSV data file via the device.

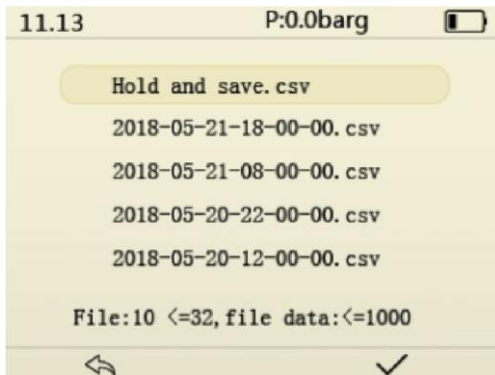

To view the saved data, press the right or left key. To view the next or previous data, press the up/down arrow keys to scroll through the data in steps of ten.

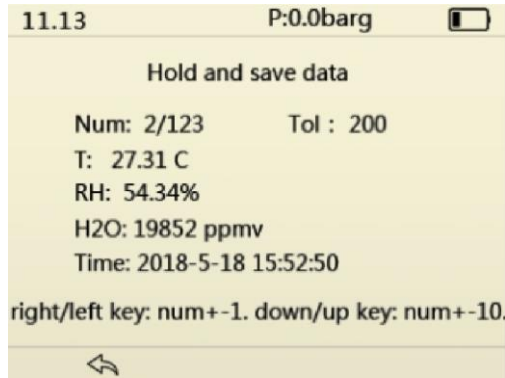

5.3 Display settings

In the display setting, you can select parameters. The temperature T is permanently selected and cannot be deselected. You can select or deselect all other parameters as you wish with the enter key.

Attention: You can select a maximum of two parameters. If you want to select a new parameter, you must first remove the other parameter.

The parameters can also be changed with the on/off key or the hold key. (For T d/f - dew point, for example, you can switch between Fahrenheit and Celsius).



5.4 Environmental parameters/ measurement settings

Can be selected to adjust the ambient pressure P of the probe and the molar mass of the gas measured in the probe.



5.4.1 Setting the probe pressure

Here you can set the pressure value P of the measured gas and the corresponding unit bara, barg, psia or psig. Change the value and select the unit by pressing the arrow up or down keys.

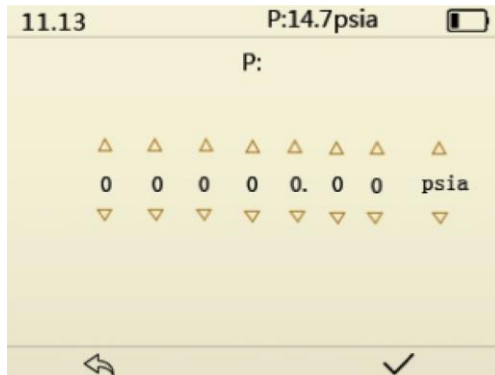

5.4.2 Adjust molar mass

The molar mass of air is 28.96 g/mol, and the molar mass of SF₆ gas is 146.05 g/mol. When measuring SF₆ gas, for example, ppmw M must be set to 146.05 g/mol. Change the value and select the unit by pressing the arrow up or down keys.



5.4.3 Cleaning

Select the "Cleaning" option and press the enter key. The probe will perform the cleaning and heat the sensor. The process takes about five to ten minutes.

5.5 Further settings

1 Language setting: Chinese and English.

2 Automatic power-off: off, 10 min, 15 min, 20 min, 25 min, 30 min

3 Brightness: Press the enter key to change the value. 10 different brightness levels can be selected.



Set the time and date, increase or decrease the number with the up or down keys and confirm your entry with the enter key.



The key sound can be enabled or disabled.

6 Contact

If you have any questions, suggestions or technical problems, please do not hesitate to contact us. You will find the relevant contact information at the end of this user manual.

7 Disposal

For the disposal of batteries in the EU, the 2006/66/EC directive of the European Parliament applies. Due to the contained pollutants, batteries must not be disposed of as household waste. They must be given to collection points designed for that purpose.

In order to comply with the EU directive 2012/19/EU we take our devices back. We either re-use them or give them to a recycling company which disposes of the devices in line with law.

For countries outside the EU, batteries and devices should be disposed of in accordance with your local waste regulations.

If you have any questions, please contact PCE Instruments.



PCE Instruments contact information

Germany

PCE Deutschland GmbH
Im Langel 4
D-59872 Meschede
Deutschland
Tel.: +49 (0) 2903 976 99 0
Fax: +49 (0) 2903 976 99 29
info@pce-instruments.com
www.pce-instruments.com/deutsch

United Kingdom

PCE Instruments UK Ltd
Unit 11 Southpoint Business Park
Ensign Way, Southampton
Hampshire
United Kingdom, SO31 4RF
Tel: +44 (0) 2380 98703 0
Fax: +44 (0) 2380 98703 9
info@pce-instruments.co.uk
www.pce-instruments.com/english

The Netherlands

PCE Brookhuis B.V.
Institutenweg 15
7521 PH Enschede
Nederland
Telefoon: +31 (0)53 737 01 92
info@pcebenelux.nl
www.pce-instruments.com/dutch

United States of America

PCE Americas Inc.
1201 Jupiter Park Drive, Suite 8
Jupiter / Palm Beach
33458 FL
USA
Tel: +1 (561) 320-9162
Fax: +1 (561) 320-9176
info@pce-americas.com
www.pce-instruments.com/us

France

PCE Instruments France EURL
23, rue de Strasbourg
67250 Soultz-Sous-Forets
France
Téléphone: +33 (0) 972 3537 17
Numéro de fax: +33 (0) 972 3537 18
info@pce-france.fr
www.pce-instruments.com/french

Italy

PCE Italia s.r.l.
Via Pesciatina 878 / B-Interno 6
55010 Loc. Gragnano
Capannori (Lucca)
Italia
Telefono: +39 0583 975 114
Fax: +39 0583 974 824
info@pce-italia.it
www.pce-instruments.com/italiano

China

PCE (Beijing) Technology Co., Limited
1519 Room, 6 Building
Zhong Ang Times Plaza
No. 9 Mentougou Road, Tou Gou District
102300 Beijing, China
Tel: +86 (10) 8893 9660
info@pce-instruments.cn
www.pce-instruments.cn

Spain

PCE Ibérica S.L.
Calle Mayor, 53
02500 Tobarra (Albacete)
España
Tel. : +34 967 543 548
Fax: +34 967 543 542
info@pce-iberica.es
www.pce-instruments.com/espanol

Turkey

PCE Teknik Cihazları Ltd.Şti.
Halkalı Merkez Mah.
Pehlivan Sok. No.6/C
34303 Küçükçekmece - İstanbul
Türkiye
Tel: 0212 471 11 47
Faks: 0212 705 53 93
info@pce- cihazlari.com.tr
www.pce-instruments.com/turkish

Hong Kong

PCE Instruments HK Ltd.
Unit J, 21/F., COS Centre
56 Tsun Yip Street
Kwun Tong
Kowloon, Hong Kong
Tel: +852-301-84912
jyi@pce-instruments.com
www.pce-instruments.cn