



User Manual

PCE-VE 250 Industrial Borescope



User manuals in various languages (français, italiano, español, português, nederlands, türk, polski, русский, 中文) can be found by using our product search on: www.pce-instruments.com

Last change: 23 October 2019
v1.0



Contents

1	Safety notes	1
2	Specifications	2
2.1	Technical specifications	2
2.2	Delivery contents	3
3	System description	3
3.1	Device	3
3.2	Display	4
3.3	Handheld device	5
3.4	Camera and cleaning head	5
4	Getting started	6
4.1	Insert micro SD card	6
4.2	Assembly/disassembly of the display	6
4.3	Charging	6
5	Operation	6
5.1	On/off	6
5.2	Taking a picture	6
5.3	Recording settings	6
5.4	Video recording	7
5.5	Viewing the saved data	7
5.6	Cleaning function	7
5.7	Settings	8
6	Operating conditions	9
7	Troubleshooting	9
8	Warranty	10
9	Disposal	10

1 Safety notes

Please read this manual carefully and completely before you use the device for the first time. The device may only be used by qualified personnel and repaired by PCE Instruments personnel. Damage or injuries caused by non-observance of the manual are excluded from our liability and not covered by our warranty.

- The device must only be used as described in this instruction manual. If used otherwise, this can cause dangerous situations for the user and damage to the meter.
- The instrument may only be used if the environmental conditions (temperature, relative humidity, ...) are within the ranges stated in the technical specifications. Do not expose the device to extreme temperatures, direct sunlight, extreme humidity or moisture.
- Do not expose the device to shocks or strong vibrations.
- The case should only be opened by qualified PCE Instruments personnel.
- Never use the instrument when your hands are wet.
- You must not make any technical changes to the device.
- The appliance should only be cleaned with a damp cloth. Use only pH-neutral cleaner, no abrasives or solvents.
- The device must only be used with accessories from PCE Instruments or equivalent.
- Before each use, inspect the case for visible damage. If any damage is visible, do not use the device.
- Do not use the instrument in explosive atmospheres.
- The measurement range as stated in the specifications must not be exceeded under any circumstances.
- Non-observance of the safety notes can cause damage to the device and injuries to the user.
- The borescope has been developed for industrial use and must not be used for medical purposes.
- Never target persons or animals with the device.
- Only use the device for the intended purpose.

We do not assume liability for printing errors or any other mistakes in this manual.

We expressly point to our general guarantee terms which can be found in our general terms of business.

If you have any questions please contact PCE Instruments. The contact details can be found at the end of this manual.

2 Specifications

2.1 Technical specifications

Main unit	
Display	3.5" TFT LCD
Resolution video function	AVI (640 x 480)
Resolution image function	JPEG (640 x 480)
Image rotation	360° rotation und mirror function
Freeze function	Yes
Zoom	4-fold, digital
Storage medium	Micro SD card (4 GB)
Menu languages	German English Spanish French Russian Japanese simplified Chinese traditional Chinese
Interfaces	Micro USB 2.0, TV output, Micro SD card slot
TV output	PAL
Power supply	Li-ion battery (2600-mAh)
Typical battery life per battery charge	4 hours in continuous operation
Protection class	Splashproof
Endoscope cable	
Camera head diameter	8.5 mm / 0.33 in
Cable diameter	4.5 mm / 0.18 in
Cable length	ca. 90 cm / 2ft 11 in
Camera resolution	720 x 576 Pixel
Camera lighting	6 white LEDs (adjustable intensity)
Field of view / angle of view	60°
Field of view depth	30 ... 60 mm / 1.18 ... 2.36 in
Push cable	semi-flexible
Environmental conditions of digital endoscope PCE-VE 250	
Operating temperature probe	In air: -10 ... 50°C / 14 ... 122°F In water: 5 ... 50°C / 41 ... 122°F
Operating temperature main unit	In air: -10 ... 50°C / 14 ... 122°F
Relative humidity probe and main unit	15 ... 90%
Liquid resistance probe and main unit	Machine oil, light oil or saline solution 5%
Probe	Water, oil and dust, to protection class IP67
Main unit	Splash-proof (with closed battery compartment) not usable under water

2.2 Delivery contents

- 1 x Industrial Borescope PCE-VE 250
- 1 x Attachable TFT LCD
- 1 x AV output cable
- 1 x USB cable
- 1 x Car charging adapter
- 1 x Micro SD card
- 1 x Liquid container
- 1 x Carrying case
- 1 x Quick shut-off valve
- 1 x User manual

3 System description

3.1 Device



1. Display unit
2. Borescope
3. Camera cable
4. Liquid container

 **3.2 Display**

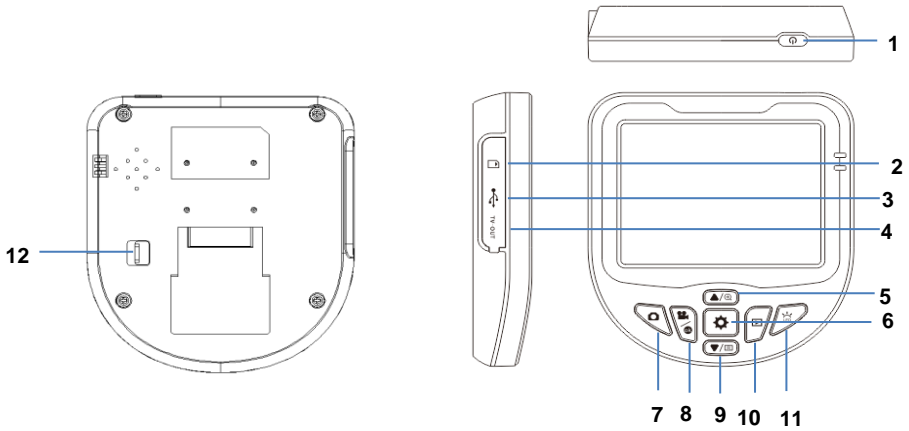

- 1. On/off key
- 2. Micro SD card slot
- 3. Micro USB 2.0
- 4. TV output
- 5. Up/zoom key
- 6. Settings key
- 7. Image key
- 8. Video/OK key
- 9. Down/rotation key
- 10. Image memory key
- 11. LED key
- 12. Display lock

3.3 Handheld device

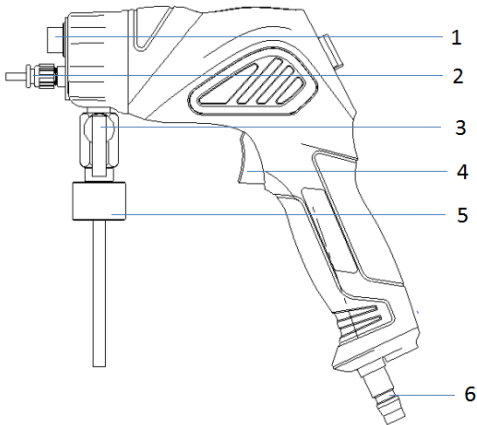

1. Pipe connection
2. Cleaning outlet
3. Shut-off valve
4. Cleaning button
5. Liquid container connection
6. Compressed air connection

3.4 Camera and cleaning head

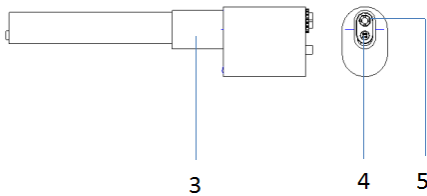

1. Borescope head
2. Cleaning nozzle
3. Camera



4 Getting started

4.1 Insert micro SD card

Before using the device, insert the micro SD card into the card slot (not included).

4.2 Assembly/disassembly of the display

Slide the display down onto the handheld device until it locks in place.

To disassemble the display, slide the lock at the rear side of the display outwards and pull up the display to remove it.

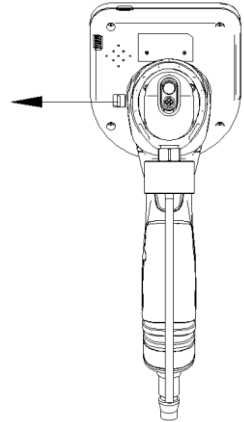

4.3 Charging

The device can be charged via the USB interface, using a micro USB charger or the included car charging adapter.

5 Operation

5.1 On/off

Short-press the on/off key  to turn the meter on or off.

5.2 Taking a picture

Press the image key  to save the currently displayed image to the SD card. After saving the image, the meter will automatically return to view mode.

5.3 Recording settings

With the LED key  , you can set the brightness at the camera head in 4 levels: off, level 1, level 2 and level 3. The LED icon in the lower right-hand part of the display shows the brightness you have set.



You can set the zoom in 3 levels with the up/zoom key  . The current zoom is shown with a magnifying glass at the lower edge of the display.

To rotate the displayed image, press the down/rotation key  .

5.4 Video recording

Press the video/OK key to start recording a video. A video icon in the display shows that a video is being recorded. Press the key again to stop recording. The video icon will disappear from the display. The video will automatically be saved to the SD card when recording is finished.

5.5 Viewing the saved data

Press the image memory key  to view the saved images and videos. You can navigate through the records with the arrow keys  . The files are sorted by date and type.

5.6 Cleaning function

For cleaning, you can either use compressed air only or compressed air and water and/or a cleaning agent. However, compressed air is needed for cleaning with a liquid as the compressed air moves the liquid out of the nozzle. The liquid container must be placed onto the tube and fixed with the union nut.

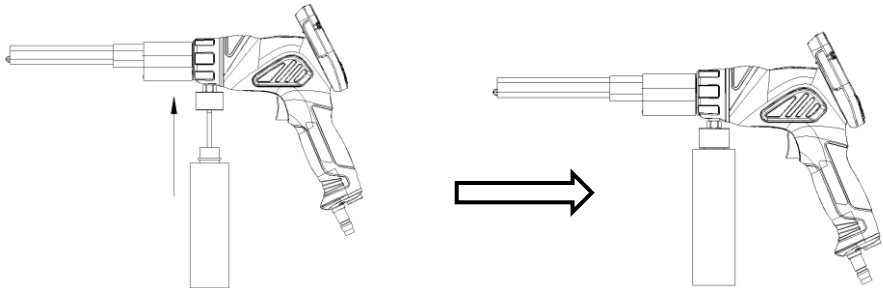

To use the cleaning function, place the camera cable where required and push the cleaning button (4) of the handheld unit. If you wish to clean with liquid, the shut-off valve (3) must be opened.



Borescope PCE-VE 250
with open shut-off valve



Borescope PCE-VE 250
with closed shut-off valve

To enter the settings, press the settings key  and select language selection, time setting, automatic shutdown setting or memory card format with the arrow up/down keys.

- **Language**

Select "language selection" from the menu and press the video/OK key to enter language selection mode. Use the navigation keys (▲ and ▼) to select the desired language and confirm your selection with the video/OK key.

- **Date/time**

Select "time setting" from the menu and press the video/OK key. Use the navigation keys (▲ and ▼) to set the desired value.

With the image memory key , you can navigate through the parameters.

- **Energy saving**

By selecting "shutdown setting", you can set the time after which the device will turn off automatically. Set the desired time by using the navigation keys (▲ and ▼) and confirm your selection with the video/OK key.

- **Formating the memory card**

In the menu item "memory card format", you can set the inserted SD card.

Note: When you format the SD card, all saved files will be deleted from the SD card irrevocably!

6 Operating conditions

Operating conditions of the industrial borescope PCE-VE 250		
Operating temperature	Probe	In the air: -10 ... +50 °C In water: +5 ... +50 °C
	Main unit	In the air: -10 ... +50 °C
Relative humidity	Probe and main unit	15 ... 90 %
Liquid resistance	Probe and main unit	Machine oil, light oil or saline solution 5 %
Ingress protection	Probe	Water, oil and dust, IP67 protection
	Main unit	Splash-proof (when battery compartment is closed), not submersible

7 Troubleshooting

Problem	Reason	Solution
The borescope does not power on	Battery flat	Charge the meter by using the USB cable
No records can be saved	No memory card inserted	Insert an SD card
No liquid comes out of the nozzle	No or insufficient compressed air	Connect compressed air and ensure 6-8 bar connection pressure



8 Warranty

You can read our warranty terms in our General Business Terms which you can find here: <https://www.pce-instruments.com/english/terms>.

9 Disposal

For the disposal of batteries in the EU, the 2006/66/EC directive of the European Parliament applies. Due to the contained pollutants, batteries must not be disposed of as household waste. They must be given to collection points designed for that purpose.

In order to comply with the EU directive 2012/19/EU we take our devices back. We either re-use them or give them to a recycling company which disposes of the devices in line with law.

For countries outside the EU, batteries and devices should be disposed of in accordance with your local waste regulations.

If you have any questions, please contact PCE Instruments.



PCE Instruments contact information

Germany

PCE Deutschland GmbH
Im Langel 4
D-59872 Meschede
Deutschland
Tel.: +49 (0) 2903 976 99 0
Fax: +49 (0) 2903 976 99 29
info@pce-instruments.com
www.pce-instruments.com/deutsch

Germany

PCE Produktions- und
Entwicklungsgesellschaft mbH
Im Langel 26
D-59872 Meschede
Deutschland
Tel.: +49 (0) 2903 976 99 471
Fax: +49 (0) 2903 976 99 9971
info@pce-instruments.com
www.pce-instruments.com/deutsch

The Netherlands

PCE Brookhuis B.V.
Institutenweg 15
7521 PH Enschede
Nederland
Telefoon: +31 (0)53 737 01 92
info@pcebenelux.nl
www.pce-instruments.com/dutch

United States of America

PCE Americas Inc.
711 Commerce Way suite 8
Jupiter / Palm Beach
33458 FL
USA
Tel: +1 (561) 320-9162
Fax: +1 (561) 320-9176
info@pce-americas.com
www.pce-instruments.com/us

France

PCE Instruments France EURL
23, rue de Strasbourg
67250 Soultz-Sous-Forêts
France
Téléphone: +33 (0) 972 3537 17
Numéro de fax: +33 (0) 972 3537 18
info@pce-france.fr
www.pce-instruments.com/french

United Kingdom

PCE Instruments UK Ltd
Unit 11 Southpoint Business Park
Ensign Way, Southampton
Hampshire
United Kingdom, SO31 4RF
Tel: +44 (0) 2380 98703 0
Fax: +44 (0) 2380 98703 9
info@pce-instruments.co.uk
www.pce-instruments.com/english

China

PCE (Beijing) Technology Co., Limited
1519 Room, 6 Building
Zhong Ang Times Plaza
No. 9 Mentougou Road, Tou Gou District
102300 Beijing, China
Tel: +86 (10) 8893 9660
info@pce-instruments.cn
www.pce-instruments.cn

Turkey

PCE Teknik Cihazları Ltd.Şti.
Halkalı Merkez Mah.
Pehlivan Sok. No.6/C
34303 Küçükçekmece - İstanbul
Türkiye
Tel: 0212 471 11 47
Faks: 0212 705 53 93
info@pce- cihazlari.com.tr
www.pce-instruments.com/turkish

Spain

PCE Ibérica S.L.
Calle Mayor, 53
02500 Tobarra (Albacete)
España
Tel. : +34 967 543 548
Fax: +34 967 543 542
info@pce-iberica.es
www.pce-instruments.com/espanol

Italy

PCE Italia s.r.l.
Via Pesciatina 878 / B-Interno 6
55010 Loc. Gragnano
Capannori (Lucca)
Italia
Telefono: +39 0583 975 114
Fax: +39 0583 974 824
info@pce-italia.it
www.pce-instruments.com/italiano

Hong Kong

PCE Instruments HK Ltd.
Unit J, 21/F., COS Centre
56 Tsun Yip Street
Kwun Tong
Kowloon, Hong Kong
Tel: +852-301-84912
jyi@pce-instruments.com
www.pce-instruments.cn