



PCE Americas Inc.
711 Commerce Way
Suite 8
Jupiter
FL-33458
USA
From outside US: +1
Tel: (561) 320-9162
Fax: (561) 320-9176
info@pce-americas.com

PCE Instruments UK Ltd.
Units 12/13
Southpoint Business Park
Ensign way
Hampshire / Southampton
United Kingdom, SO31 4RF
From outside UK: +44
Tel: (0) 2380 98703 0
Fax: (0) 2380 98703 9
info@industrial-needs.com

www.pce-instruments.com/english
www.pce-instruments.com

Manual Relative Humidity Meter PCE-313



CONTENTS

<i>TITLE</i>	<i>PAGE</i>
I. Safety Information	1
II. Introduction	1
III. Specifications	1
IV. Symbol Definition and Button Location	2
V. Operation Instructions	3
4.1 Power-Up.....	3
4.2 Humidity and Temperature Measurement.....	3
4.3 Selecting the Temperature Scale.....	3
4.4 Data-Hold Operation.....	3
4.5 DataLogger.....	3
4.6 Clock Setup	3
4.7 Recording Interval Setup.....	4
4.8 Time Operation.....	4
4.9 MAX/MIN Operation.....	4
4.10 Auto Power Off.....	4
4.11 Low Battery Condition	4
4.12 Digital Output.....	4
VI. Setup TestLink (Humidity Temperature DataLogger)— RS232 interface software	7

I. Safety Information

Read the following safety information carefully before attempting to operate or service the meter. Use the meter only as specified in this manual; otherwise, the protection provided by the meter may be impaired.

Environment conditions

- o Altitude up to 2000 meters
- o Relatively humidity 90% max.
- o Operation Ambient 0 ~ 50°C

Maintenance & Clearing

- o Repairs or servicing not covered in this manual should only be performed by qualified personnel.
- o Periodically wipe the case with a dry cloth. Do not use abrasives or solvents on this instrument.

Safety symbols



Comply with EMC



Read safety Information first.

II. Introduction:

This instrument is a digital Humidity/Temperature meter that uses a polymer capacitive and semiconductor sensor. This operations manual contains general product information and specifications. Its internal memory can keep up to 16300 readings. (note1.) It uses a RS232 interface to perform bi-directional communication with PC.

III. Specifications:

Numerical Display : 4 digital Liquid Crystal Display.

Measurement Range : Humidity: 0%~100%RH

Temperature: -20°C~+60°C -4°F~+140°F

Resolution : 0.1%RH , 0.1°C,0.1°F

Accuracy : Humidity:±2.5%RH at 25°C

Temperature: ±0.7°C ±1.4°F

Response Time : Humidity: 75 sec. In slowly moving air

Temperature: 40 sec. in slowly moving air

Signal Output : RS-232 Data Output

Operating Environment : 0°C~50°C, 32°F~122°F 0 to 90%RH non-condensing

Storage Environment : -10°C~60°C, 14°F~140°F 0 to 80%RH non-condensing

Power Requirements : Battery: One 9V battery 006p or IEC 6F22 or NEDA1604
AC adapter: 9Vdc / 10mA minimum

Plug Diameter: 3.5 mm×1.35mm

Battery Life : Approx. 100hrs with alkaline battery

Weight : Approx.320g

note1:

Every time you press "REC" button to start recording data and press "REC" button again to stop

recording, there will be a data set in memory, you can store as many data sets as you want until memory is full.

Dimension : Meter = 186(L)×64(W)×30(H)mm ; 10.8(L)×2.5(W)×1.2(H)inch

Probe = 190(L)×15(D)mm ; 7.5(L)×0.6(D)inch

Accessories : Instruction Manual, 9V Battery, Carrying Case, Software, RS-232 Cable, Probe Holder.

IV. Symbol Definition and Button Location:

°C°F : Centigrade and Fahrenheit indication.

%RH : Relative Humidity indication.

MAX : The Maximum value is now being displayed

MIN : The Minimum value is now being displayed

 : This indicates auto power off is enabled.

 : This indicates that the display data is being held.

m-d : month and day

h:m : hour and minute

m:s : minute and second

Y : year

 : The Battery is not sufficient for proper operation.

REC : This indicates that the tester is recording. If it blinks, it indicates the memory is full.

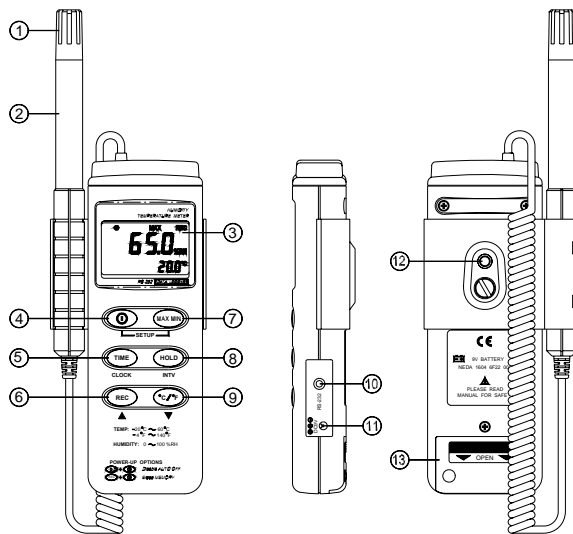
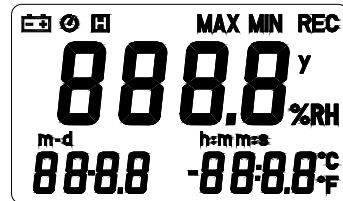

Button Location:

- ,1 Dust mask
- ,2 Sensor probe
- ,3 LCD display
- ,4 ON/OFF button
- ,5 Time display button
- ,6 Record button
- ,7 MAX MIN function control button
- ,8 HOLD button
- ,9 °C, °F control button
- ,10 Digital output connector (RS-232)
- ,11 AC power adapter connector

- ,¹² Tripod connector
- ,¹³ Battery cabinet cover

V. Operation Instructions:

4.1 Power-Up

Press the power button to turn the Humidity Temperature Meter ON or OFF.
When the powered it on, the LCD will show how much memory space is available to use.

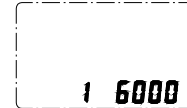

For example: It indicates that there are 16,000 records memory space available.

4.2 Humidity and Temperature Measurement

For measurement, place the sensor probe in the test environment.

4.3 Selecting the Temperature Scale

When the meter is first powered on, the default scale setting is set at Celsius (°C) scale. The user may change it to Fahrenheit (°F) by pressing " °C/°F " button and vice versa to Celsius. Next time you power on, the scale setting will be the same as which when you powered off last time.

4.4 Data-Hold Operation

The user may hold the present reading and keep it on the display by pressing the "HOLD" button. When the held data is no longer needed, one may release the data-hold operation by pressing "HOLD" button again.

When the meter is under Data Hold operation, the "MAX MIN" and " °C/°F " button are disabled. (when you press " °C/°F " and "MAX MIN" button in HOLD mode, there will be two continuous beeps)

4.5 Data Logger

When pressing the "REC" button, the meter will start recording, press the "REC" button again will stop recording, If you want to clear the memory, power off the meter, then press and hold "REC" button and then press power button, then release all buttons ,then LCD will show "CLR" to clear the memory.



4.6 Clock Setup



1: press and hold "MAX MIN" button and then power on the meter:

2: press "TIME"(clock):



3: press "REC" ▲ or "°C/°F" ▼ to increase or decrease number, press "TIME"(clock) to adjust next item. The adjusting order is

year→ month→ day→ hour→ minute, then press "TIME" (clock) to finish adjusting. If you want abort during a setup process, press power button to cancel.

4.7 Recording Interval Setup :



1: press and hold "MAX MIN" button and then power on the meter:

2: press "HOLD"(INTV)

3: press "REC" ▲ or "°C/°F" ▼ to increase or decrease number, press "HOLD" (INTV) to adjust next item, then press "HOLD" (INTV) to finish. If you want abort during a setup process, press power button to cancel.

4.8 Time Operation:

When pressing the "TIME" button, the LCD will display time , it will show year on top of the LCD, show month and day on the left bottom of the LCD, show hour and minute on the right bottom of the LCD. Press "TIME" button or any other button to exit this mode. This operation will not interrupt the recording and "MAX MIN" operation.

4.9 MAX/MIN Operation:

When pressing the "MAX MIN" button the meter will enter the MAX/MIN mode. Under this mode the maximum value / minimum value is kept in the memory simultaneously and updated with every new data point.

When the MAX symbol is display, the Maximum is shown on the display.

Press "MAX MIN" again, then the MIN symbol is on the display and the minimum reading is displayed.

Press "MAX MIN" again, MAX, and MIN will blink together. This means that all data is updated in the memory and the reading is the present temperature.

One may press "MAX MIN" to circulate the display mode among these options.

When the meter is under "MAX MIN" operation, " °C/°F " button are disabled.(when you press " °C/°F " button in "MAX MIN" mode, there will be two continuous beep)

To exit the MAX/MIN mode, one may press and hold "MAX MIN" for two seconds.

4.10 Auto Power Off:

By default, when the meter is powered on, it is under auto power off mode. The meter will power itself off after 30 minutes if no key operation and no RS232 communication and no recording. Combination at power on can disable auto power off.

One may press and hold "HOLD" button and then power on the meter and there will be two successive beeps to indicate that auto power off is disabled and the  will not show up.

4.11 Low Battery Condition

When the battery voltage is under proper operation requirement, the  symbol will show on the LCD and the battery need to be replaced with new one.

4.12 Digital Output:

The Digital Output is a 9600bps N 81 serial interface.

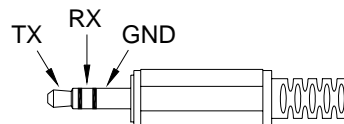

VI. Setup TestLink (Humidity DataLogger)—RS232 interface software:

- **The TestLink package contains:**
 1. One setup CD.
 2. Custom designed RS232 cable for TestLink.
- **System Required:**
Windows 98/ NT 4.0/ NT2000/ XP.
- **Minimum Hardware Required:**
486-100 MHz PC compatible, 16 MB RAM ;
At least 5 MB hard disk space available to install TestLink program. Recommended display resolution is 800X600.
- **Install TestLink:**
 1. We recommend close all other application before installing TestLink.
 2. Insert the TestLink CD-ROM into your CD drive. The TestLink installer should start automatically. If it does not, you can start it by running SETUP.EXE from the root drive of the CD-ROM.
 3. When installation is complete, it will copy TestLink.exe(executable file) and help file to your hard disk(default is c:\program files\ TestLink)
 4. For other operation instruction, please refer to the on-line help while executing TestLink.

5-1. Run TestLink

Select TestLink form “START” of Windows, figure 5.1 will show

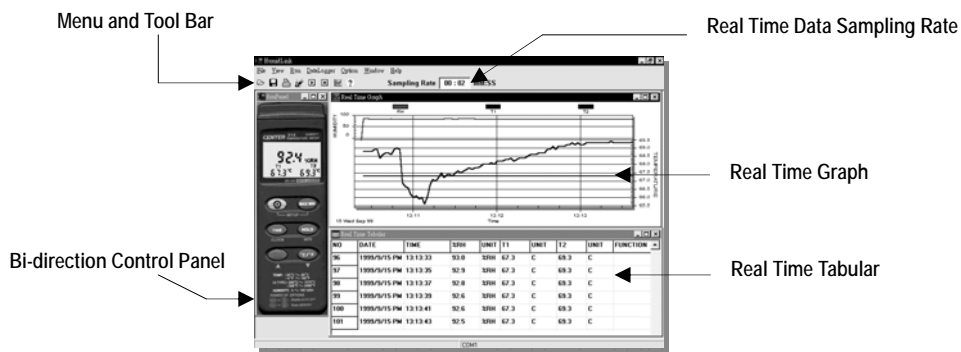



Figure 5.1

5-2. Real Time Tabular and Real Time Graph.

Select Run from menu or press  from the tool bar to begin real time data collection from humidity meter.

You can change the data interval by editing the sampling rate box on the right hand side of tool bar (see figure 5.1).

5-3. Data Logger

Select DataLogger from menu to load recorded data for humidity meter. There will be a progress bar showing how many bytes should be loaded and how many bytes have been received. When data is loaded successfully, there will be three new window show up. (see 5-2)

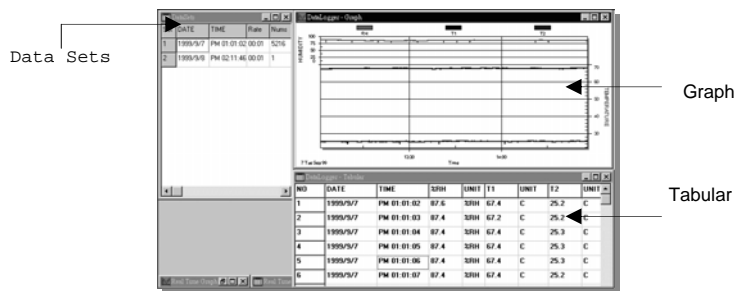

Data Sets Window – Display how many data sets were loaded and the detail information for each data set (start date, start time, recording rate and data length), and you can click at any data set to choose the set for graph and tabular Window.

5-4. For other operation instruction, please refer to the on-line help while executing TestLink.

NOTE: "This instrument doesn't have ATEX protection, so it should not be used in potentially explosive atmospheres (powder, flammable gases)."

Graph

Tabular