



PCE Americas Inc.
711 Commerce Way
Suite 8
Jupiter
FL-33458
USA
From outside US: +1
Tel: (561) 320-9162
Fax: (561) 320-9176
info@pce-americas.com

PCE Instruments UK Ltd.
Units 12/13
Southpoint Business Park
Ensign way
Hampshire / Southampton
United Kingdom, SO31 4RF
From outside UK: +44
Tel: (0) 2380 98703 0
Fax: (0) 2380 98703 9
info@industrial-needs.com

www.pce-instruments.com/english
www.pce-instruments.com

POWER ANALYZER PCE-360 INSTRUCTION MANUAL





CONTENTS

1. SAFETY INFORMATION	3
2. INTRODUCTION FEATURE	7
3. SPECIFICATIONS	9
3-1 ENVIRONMENT CONDITIONS:	9
3-2 SAFETY SPECIFICATIONS	9
3-3 GENERAL SPECIFICATION	9
3-4 ELECTRICAL SPECIFICATION	12
4. PARTS & CONTROLS	17
4-1 DESCRIPTION OF PARTS & CONTROL KEYS	17
4-2 DESCRIPTION OF DISPLAY	23
5. OPERATING INSTRUCTION	28
5-1 AC CURRENT ADAPTOR	29
5-2 SINGLE-PHASE 2-WIRE (1P2W) POWER SYSTEM MEASUREMENT	31
5-3 SINGLE-PHASE 3-WIRE (1P3W) POWER SYSTEM MEASUREMENT	35
5-4 THREE-PHASE 3-WIRE (3P3W2M) POWER SYSTEM MEASUREMENT	39
5-5 THREE-PHASE 3-WIRE (3P3W3M) POWER SYSTEM MEASUREMENT	43
5-6 THREE-PHASE 4-WIRE (3P4W) POWER SYSTEM MEASUREMENT	46
5-7 ONLY ONE CURRENT I4 MEASUREMENT	49
5-8 MANUAL DATA MEMORY AND READ FUNCTION OPERATION	50
5-9 AUTO DATALOGGING FUNCTION OPERATION	51
5-10 PHASE SEQUENCE MEASUREMENT	53
5-11 VOLTAGE, CURRENT WAVEFORM AND HARMONIC ANALYZER	54



5-12 ENABLE AUTO POWER OFF FUNCTION	54
6. MAINTENANCE	55
6-1 GENERAL MAINTENANCE	55
6-2 BATTERY REPLACEMENT	55
7. SOFTWARE INSTALLATION AND OPERATION	56
WARRANTY	74
DISPOSAL.....	74

1. SAFETY INFORMATION

This Instruction Manual provides information and warnings essential for operating this meter in a safe manner and for maintaining it in safe operating condition. Before using this meter, be sure to carefully read the following safety information.



DANGER

- During high voltage measurement, incorrect measurement procedures could result in injury or death, as well as damage to the meter. Please read this manual carefully and be sure that you understand its contents before using the meter.



DANGER

- Do not use the meter or test leads if they look damaged.
- Use extreme caution when working around bare conductors or bus bars, Accidental contact with the conductor could result in electric shock.
- To avoid damages to the meter, do not exceed the maximum limits of the input values shown in the specifications.
- Use the meter only as specified in this manual, otherwise, the protection provided by the meter may be impaired.

SAFETY SYMBOLS

- Caution refer to this manual before using the meter.
- This symbol is affixed to the meter where the operator should consult corresponding topics before using relevant functions of the meter.
- This mark indicates explanation, which is particularly important that the user should read before using the meter.



Dangerous voltages.



Meter is protected throughout by double insulation or reinforced insulation.

When servicing, use only specified replacement parts.



Comply with IEC61010-1, 2nd edition



DANGER: Indicates that incorrect operation presents extreme danger of accident resulting in death or serious injury to the user.



WARNING: Indicates that incorrect operation presents significant danger of accident resulting in death or serious injury to the user.



CAUTION: Indicates that incorrect operation presents possibility of injury to the user or damage to the meter.

NOTE: Denotes items of advice related to performance of the meter or to its correct operation.

NOTES ON USE

In order to ensure safe operation and to obtain maximum performance from the meter, observe the caution listed below.

Installation



CAUTION

- The meter is designed for indoor use and can be safely used at temperatures ranging from 0°C to 40°C.
- Do not store or use the meter where it will be exposed to direct sunlight, high temperature, high humidity, or condensation, if exposed to such conditions, the meter may be damaged, the insulation may deteriorate, and the meter may no longer satisfy its specifications.
- The meter does not construct to be waterproof or dustproof, so do not use it in a very dusty environment or in one where will get wet.
- Do not use the unit where it may be exposed to corrosive or explosive gas. The meter may be damaged, or may occur explosion.

Before use



WARNING

- To prevent electric shock, do not allow the meter to become wet and do not use the unit when your hands are wet.
- When working with live circuits, take all suitable precautions against accidents, including the use of electrical safety gear such as rubber gloves, rubber boots, and safety helmets.

Connecting meter



WARNING

- To prevent electric shock, turn the power off before connecting the test leads and then take measurements.
- In order to prevent electrical shock and short – circuit accidents, shut off the power to the line to be measured before connecting the line to be measured to the voltage input terminals.



CAUTION

- The measurement input and synchronizing input are not isolated from each other. Connecting either one means that the other is exposed it is live, and there is a danger of electric shock. To avoid electrical shock, connect both terminals.

User Manual



WARNING

To avoid electrical shock and / or meter damage, use caution when connecting test leads to live components. The jaws of alligator clips can create a short circuit between closely spaced live parts. Avoid making connections to feeder conductors or bus bars at elevated potentials. Whenever, please make connections to the output side of a circuit breaker as possible as you can, which can provide better short circuit protection.

- Follow all legal requirements.
- Follow all instructions in the manuals.
- Obey posted instructions.
- Never assume that a circuit is de-energized, check it first.
- Always set up the measurement first, then connect the test leads to the circuit.
- Remove all test leads that are not in use.
- Make connections to the meter first, before connecting leads to a live circuit.
- Connect the ground lead first, then the voltage leads and the current probe, Disconnect in reverse order.
- Route test leads carefully.

The symptoms of poor power quality include intermittent lock-ups and resets, corrupted data, premature equipment failure, over-heating of components for no apparent cause, etc. The ultimate cost is in downtime, decreased productivity and frustrated personnel.

Use power analyzer to power quality trouble shooting can help you keep your power system up and running, troubleshoot problems quickly, improve power efficient, manage energy costs, zero in on harmonics, optimize power system performance, improve power quality and analyze system data to design optimal upgrades.

- 10 display Easy-to-view LCD screen, and is capable of showing many power quality parameters at the same time.
- 4 current probe including for measuring a neutral line current.
- Measures single-phase 2-wire, single-phase 3-wire, three-phase 3-wire and three-phase 4-wire systems.
- All True-RMS sensing, V, A, KW, KVAR, KVA, PF, Θ , Hz, kWh, KVARh and KVAh measurements.
- KW, KVA, KVAR Maximum/Minimum recording.
- Voltage and Current waveform THDF, THDR measurements.
- Harmonic Analysis to the 63th order.
- Phase sequence indicator function.
- Backlight display function.
- Manual Data Memory and Read (50 sets).
- Data logging (micro SD CARD 4GB).
- USB optical interface with three phase voltage / current waveform display and harmonic analysis.
- Easy-to-use key operation.
- Light weight and portable design.

3. SPECIFICATIONS

3-1 Environment Conditions:

- ① Altitude up to 2000 meters
- ② Indoor use only
- ③ Relatively humidity 80% max.
- ④ Operation ambient 0 ~ 40°C

3-2 Safety Specifications

Category Rating: 1000V Measurement Category III, Pollution Degree 2.

CE: IEC 61010-1 2nd Edition

CAT III: Measurement category in which measurements performed in the building installation.

Safety Characteristics:

Only the supplied current clamps are to be used only with the Three-Phase Power Analyzer PCE-360.

This manual contains information and warning that must be followed by the user to ensure safe operation and to keep the meter and its accessories in a safe condition.

Use of this meter and its accessories in a manner not specified by the manufacturer may impair the protection provided by the equipment.

Equipment operation, the responsible body shall be made aware that, if the equipment is used in a manner not specified by the manufacturer, the protection provided by the probe assembly may be impaired.

3-3 General Specification

- Maximum voltage between voltage input terminals and earth ground: 1000 Vrms
- Maximum rated working voltage for current input: 0.35 Vrms
- Maximum current for current probe: 1000 Arms
- Numerical 10 display: 10 display 4 digit LCD maximum reading 9999.
- Battery life: approx. 50 hours.
- Auto power off: approx. 30 minutes.
- Low battery indication: The **BT** is displayed when the battery voltage drops below the operating voltage.
- Backlight display time: Auto off approx. 30 seconds.
- Sampling rate : Approx. 1 time per 1 seconds (Digital display).
- Harmonic analyzer: 1 ~ 63th order.
- Manual data memory and read capacity: 50 sets.
- Data logger capacity: micro SD CARD 4GB (Maximum 99 blocks).
- Current probe jaw opening diameter: Cables ψ 40mm.
- Operating temperature: 0°C to 40°C
- Operating humidity: Maximum relative humidity of 80% for temperatures up to 31°C decrease linearly to 50% relative humidity at 40°C (non-condensed).
- Temperature coefficient: $0.1 \times (\text{specified accuracy}) / ^\circ\text{C}$ (<18 or >28°C)
- Storage temperature and humidity: -10°C to 60°C / R.H. < 70% non-condensed.
- Dimensions: Meter → 235(L)×117(W)×54(H)mm.
Current probe → 193(L)×88(W)×40(H)mm.
- Weight: Meter including battery → approx. 730g
Current probe → approx. 333g
- Accessories:



User Manual

- 1 x PCE-360 Clamp Meter
- 4 x Current clamps
- 4 x Measuring leads
- 4 x Alligator clips
- 8 x 1.5 V AA batteries
- 1 x Power adapter
- 1 x USB cable
- 1 x PC software CD-ROM
- 1 x User manual
- 1 x Carrying case

3-4 Electrical Specification

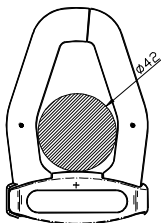

Accuracy: \pm (% of reading + number of digits) at 18°C to 28°C (64°C to 82°C) with relative humidity to 80%.

The current error is specified within the largest circle which can be drawn inside the jaw.

□ AC Voltage Trms measurement (V):

Range	Resolution	Accuracy	Input impedance	Overload protection	Nominal power system frequency
999.9V	0.1V	\pm (0.3% rdg \pm 10dgts) (>10V)	2M Ω	1000Vrms	45Hz ~ 66Hz

- Display item: RMS voltage value for each channel.

□ AC Current Trms Measurement (A):

Range	Resolution	Accuracy (including current probe)	Current probe output	Overload protection	Nominal power system frequency
999.9A	0.1A	\pm (0.5%rdg \pm 15dgts) (>10A)	0.35mV/A	1000Arms	45Hz ~ 66Hz

- Display item: RMS current value for each channel.

□ Active Power measurement P (KW):

Range	Resolution	Accuracy
999.9KW	0.1KW	\pm 1.0%rdg \pm 20dgts

- Display items: Active power of each channel and its sum of multiple channels.
- Polarity display: For influx (consumption) No symbol, For outflow (regenerative) “ - ”.

□ Apparent Power measurement S (KVA):

Range	Resolution	Accuracy
999.9KVA	0.1KVA	±1.0%rdg±20dgts

- Measurement method: Calculate from RMS voltage U and RMS current I.
- Display item: Apparent power of each channel and its sum of multiple channels.
- Polarity display: No polarity.

□ Reactive Power measurement Q (KVAR):

Range	Resolution	Accuracy
999.9KVAR	0.1KVAR	±1.0%rdg±20dgts

- Measurement method: Calculate from apparent power S and active power

$$P,$$

$$Q = \sqrt{S^2 - P^2}.$$

- Display item: Reactive power of each channel and its sum of multiple channels.
- Polarity display: For phase lag (LAG: current is slower than voltage): “-”
For lead phase (LEAD: current is faster than voltage):
No symbol.

□ Power Factor measurement (COS ψ):

Range	Resolution	Calculated Accuracy
-1 ~ +1	0.001	± 10 dgt

- Measurement method: Calculate from apparent power S and active power

P,

$$PF = \text{COS}\psi = |P|/S$$

- Display item: Power factor of each channel and its sum of multiple channels.

□ Phase angle measurement (ψ):

Range	Resolution	Calculated Accuracy
+180° ~ 0° ~ -180°	0.1°	± 15 dgt

- Measurement method: Calculate from power factor COS ψ , $\psi = \text{COS}^{-1}PF$.
- Display item: Phase angle of each channel and its sum of multiple channels.
- Polarity display: For phase lag (LAG: current is slower than voltage): "-".
For phase lead (LEAD: current is faster than voltage):
No symbol.

□ Frequency measurement (Hz):

Range	Resolution	Accuracy	Measurement source
60HZ	0.1Hz	$\pm 0.1\%rdg \pm 2$ dgt	Voltage U1 > 10V

- Measurable input range: > 10V



☐ Three Phase Sequence Detection:

Input voltage range	Normal phase indication	Reverse phase indication	Measurement source
3P > 10V	123 ↷	123 ↶	U1, U2 and U3

☐ Active Power Energy measurement (KWh):

Range	Resolution	Active power accuracy	Timer interval	Timer Accuracy
9.999KWh	0.001KWh	±1.0%rdg±20dgt	1 sec	±50ppm (25°C, 77°F)
99.99KWh	0.01KWh			
999.9KWh	0.1KWh			
9.999MWh	0.001MWh			
30.59MWh	0.01MWh			

- Measurement display: Display all active power consumption energy (sum of absolute values).

☐ Apparent Power Energy measurement (KVAh):

Range	Resolution	Apparent power accuracy	Timer interval	Timer Accuracy
9.999KVAh	0.001KVAh	±1.0%rdg±20dgt	1 sec	±50ppm (25°C, 77°F)
99.99KVAh	0.01KVAh			
999.9KVAh	0.1KVAh			
9.999MVAh	0.001MVAh			
30.59MVAh	0.01MVAh			

- Measurement display: Display all apparent power energy (sum of absolute values).

Reactive Power Energy measurement (Kvarh):

Range	Resolution	Reactive power accuracy	Timer interval	Timer Accuracy
9.999Kvarh	0.001Kvarh	±1.0%rdg±20dgt	1 sec	±50ppm (25°C, 77°F)
99.99Kvarh	0.01Kvarh			
999.9Kvarh	0.1Kvarh			
9.999Mvarh	0.001Mvarh			
30.59Mvarh	0.01Mvarh			

- Measurement display: Display all reactive power consumption (sum of absolute values).

Harmonic measurement

Order	Accuracy	Harmonic Source
1 ~ 63	±3%THD	U1, U2, U3 > 10V I1, I2, I3 > 10A



Waveform (use only PC on line displayed)

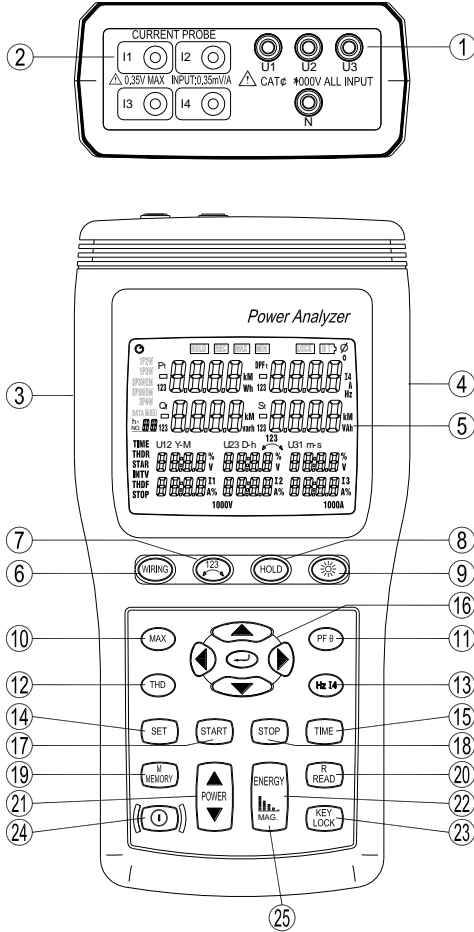

- Select phase A, B or C.
- Select Voltage and current waveform output.

4. PARTS & CONTROLS

4-1 Description of Parts & Control keys



1. Input for voltage terminals (U1, U2, U3, N).
2. Input for current probe jacks (I1, I2, I3, I4).
3. Plug for external AC adaptor power supply input.
4. Optical interface output.
5. LCD display.
6. **WIRING key**: Select the type of electrical system under test, press “**WIRING**” key to select 1P2W (To measure single-phase two-wire power lines), 1P3W (To measure single-phase three-wire power lines), 3P3W2M (To measure three-phase three-wire power line without neutral, using the two power meter method, use this when measuring three-phase power with 2-current probe measurement only.), 3P3W3M (To measure three-phase three-wire power line without neutral, using the three power meter method, use this when measuring three-phase power with 3-current probe measurement only.) and 3P4W (To measure three-phase four-wire power lines with neutral) electrical system in cycles.
7.  **key**: Phase sequence detection function key. In a 3P4W mode, press and hold down this key, it will display phase detection results as follows:
Normal phase 
Reverse phase 
8. **HOLD key**: Data hold function key, press “**HOLD**” key to hold data, the “**HOLD**” annunciator is displayed, press “**HOLD**” key again to exit Hold function.

9.  **key:** Backlight function key, press  key to turn on and off of backlight.

The backlight will switch off automatically after 30 seconds.

10. **MAX key:** Active power (P), reactive power (Q), and apparent power (S) Maximum / Minimum recording measurement.

① In the power measurement screen mode, press “◀ **POWER** ▶” key to select (P1, Q1, S1), (P2, Q2, S2), (P3, Q3, S3) or (Pt, Qt, St) which one measured value to do the maximum/minimum recording measurement.

② Press “**MAX**” key to enter this mode, the “**REC**” mark is displayed.

③ Press “**MAX**” key to cycle through the

- a). Maximum reading the “**REC MAX**” mark is displayed.

Press ▲ key to cycle through the

Maximum reading for Active power (“**P**” mark is blinking) with its Q, S, V, A reading and its PF, Θ , Hz, I4 reading by press “**PF Θ** ” and “**Hz I4**” keys.

Maximum reading for Reactive power (“**Q**” mark is blinking) with its P, S, V, A reading and its PF, Θ , Hz, I4 reading by press “**PF Θ** ” and “**Hz I4**” keys.

Maximum reading for Apparent power (“**S**” mark is blinking) with its P, Q, V, A reading and its PF, Θ , Hz, I4 reading by press “**PF Θ** ” and “**Hz I4**” keys.

- b). Minimum reading, the “**REC MIN**” mark is displayed.

Press **▲** key to cycle through the

Minimum reading for Active power (“**P**” mark is blinking) with its Q, S, V, A reading and its PF, Θ , Hz, I4 reading by press “**PF Θ** ” and “**Hz I4**” keys.

Minimum reading for Reactive power (“**Q**” mark is blinking) with its P, S, V, A reading and its PF, Θ , Hz, I4 reading by press “**PF Θ** ” and “**Hz I4**” keys.

Minimum reading for Apparent power (“**S**” mark is blinking) with its P, Q, V, A reading and its PF, Θ , Hz, I4 reading by press “**PF Θ** ” and “**Hz I4**” keys.

c). Current reading, the “**REC**” mark is displayed.

④ Press “**MAX**” key for 3 seconds to exit this mode.

11. **PF Θ key**: Display measured power factor or phase angle value control key, the “PF” or “ **ψ** ” annunciator is displayed.

12. **THD key**: Display measured voltage or current THDF, THDR value control key.

THDF: Total Harmonic Distortion of a waveform is compared to its Fundamental.

THDR: Total Harmonic Distortion of a waveform is compared to the waveforms rms value.

① Press “**THD**” key to enter the Voltage U1, U2 and U3 THDR and THDF measurement mode, the “**THDR**” and “**THDF**” marks are displayed.



② Press “**THD**” key again to enter the Current I1, I2 and I3 measurement mode, the “**THDR**” and “**THDF**” marks are displayed.

③ Press “**THD**” key again to exit this mode.





13. **Hz I4 key**: Display measured frequency or I4 current probe value control key, the “**Hz**” or “**I4**” annunciator is displayed.

14. **SET key**: Setting current date and time function key, press “**SET**” key to enter current time setting mode and interval time setting mode for auto datalogging use.

15 **TIME key**: Display current date and time control key, press and hold down “**TIME**” key display current data and time.

Press and hold down “**TIME**” key then press  key turn on the meter, the “  ” mark appear, enter into auto power off function.

16.      keys:







① In the harmonic measurement mode, press  key to select voltage or current harmonic source. Press  or  key to select which source to be displayed. Press  or  key to select harmonic order.

② Setting current date and time, or recall manual data memory to read memory data in cycles control keys.

17. **START key**: Start auto datalogging function.

18. **STOP key**: Stop auto datalogging function. Press “**START**” key to resume recording in current data sets.

19. **MEMORY key**: Manual data memory control key. Press “**MEMORY**” key each time to store one set current display reading into the memory, the “**M**” annunciator and the memory address number is displayed, total memory size is 50 sets.

20. **READ key**: Read manual memory data control key.
21. **▲POWER▼ key**: Display measured power value control key, the “Pt123”, “Qt123” and “St123” annunciators will be displayed in cycles.
22. **ENERGY key**: Display total integrated power energy value control key, the three “h” annunciators will be displayed.
23. **KEY Lock key**: Lock all the functions key, except  and  keys, the “LOCK” annunciator is displayed.
24.  **key**: Power on-off control key.
25.  **MAG. key**: Harmonic measurement control key.
- ① Press “ **MAG.**” key to enter the voltage and current waveform harmonic measurement mode, the harmonic order number “Hd:XX” and its measured value (V or A), harmonic ratio (%), P, Q, S, PF values are displayed.
 - ② Press ▲ or ▼ key to scroll the harmonic order from “Hd:01” to “Hd:63”.
 - ③ Press ↵ key to scroll the voltage or current harmonic for display.
 - ④ Press ◀ or ▶ key to scroll the U1, U2, U3 or I1, I2, I3 for display.
 - ⑤ Press “ **MAG.**” key again to exit this mode.

4-2 Description of Display

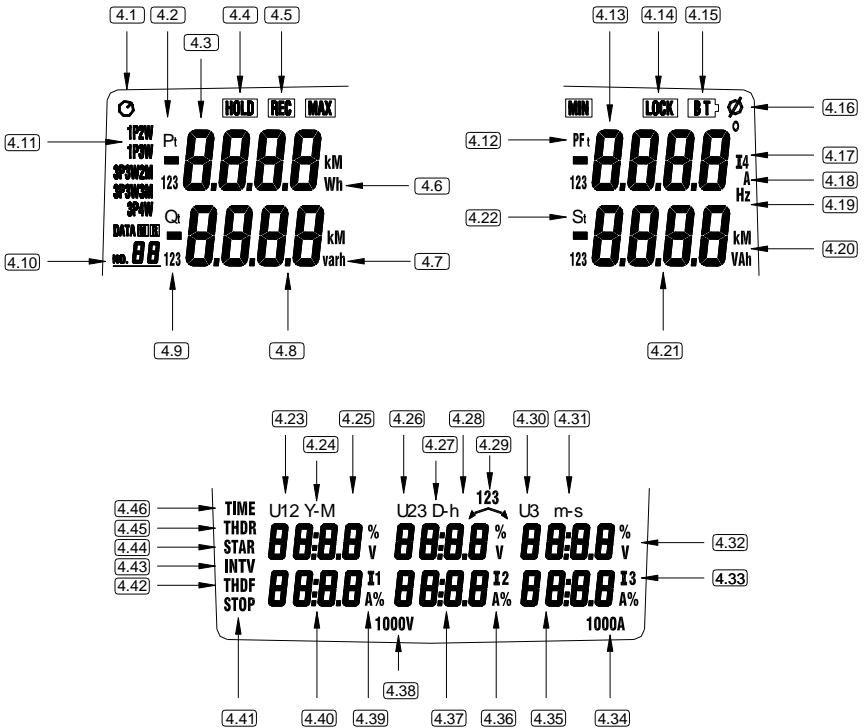

4.1	⏻ : Auto power off indication.
4.2	P : Harmonic active power measured display indicator. P1 : Phase 1 active power measured display indicator. P2 : Phase 2 active power measured display indicator. P3 : Phase 3 active power measured display indicator. Pt : Total active power measured display indicator and total active energy measured display indicator.
4.3	Display value of Active Power

4.4	HOLD : Display hold mode.
4.5	<p>REC MAX : Maximum recorded reading.</p> <p>REC MIN : Minimum recorded reading.</p> <p>REC : Recording mode indication and current reading.</p>
4.6	KW : Active Power Unit: or KWh , MWh , active energy unit.
4.7	Kvar : Reactive Power Unit or Kvarh , Mvarh reactive energy unit.
4.8	Display of reactive Power.
4.9	<p>Q : Harmonic reactive power measured display indicator.</p> <p>Q1: Phase 1 reactive power measured display indicator.</p> <p>Q2: Phase 2 reactive power measured display indicator.</p> <p>Q3: Phase 3 reactive power measured display indicator.</p> <p>Qt: Total reactive power measured display indicator and total reactive energy measured display indicator.</p>
4.10	<p>DATA <u>No.xx</u>: Last manual datalogged memory address number indication (01~50).</p> <p>M : Manual datalogged indication, M displays one time store one sets data into the memory.</p> <p>R <u>No.xx</u>: Recall manual datalogged address number indication, the memory data displayed for read.</p> <p>DATA M xx: Auto datalogging indication, M disappears one time store one sets data into the memory .</p> <p>01 ~ 99: Maximum 99 memory blocks can be use.</p> <p>FULL: Memory full indication, if exceed 99 memory blocks or micro SD CARD is full used.</p>
4.11	1P2W : Measure single-phase two-wire power line indicator.

	<p>1P3W: Measure single-phase three-wire power line indicator.</p> <p>3P3W2M: Measure three-phase three-wire power line indicator.</p> <p>3P3W3M: Measure three-phase three-wire power line using 3 power meter indication.</p> <p>3P4W: Measure three-phase four-wire power line indicator.</p>
4.12	<p>PF : Harmonic power factor measured display.</p> <p>PF1: Phase 1 power factor measured display.</p> <p>PF2: Phase 2 power factor measured display.</p> <p>PF3: Phase 3 power factor measured display.</p> <p>PFt: Total power factor measured display.</p>
4.13	Display value for Power Factor, Frequency & I4 current
4.14	LOCK : Keyboard lock indicator.
4.15	 : Low battery indicator.
4.16	<p>$^{\circ}$: Phase angle unit.</p> <p>ϕ: Phase angle display.</p>
4.17	Indicates current measurement from input "I4".
4.18	A : Unit of current.
4.19	Hz : Unit of frequency.
4.20	KVA : Apparent power unit or KVAh, MVAh: Apparent energy unit.
4.21	Display value of apparent power.
4.22	<p>S : Harmonic apparent power measured display indicator.</p> <p>S1: Phase 1 apparent power measured display indicator.</p> <p>S2: Phase 2 apparent power measured display indicator.</p> <p>S3: Phase 3 apparent power measured display indicator.</p> <p>St: Total apparent power measured display indicator and total</p>



	apparent energy measured display indicator.
4.23	U1: Indicates the display of voltage on phase 1(U1), THDR %, THDF % or Harmonic.
4.24	Y-M: Year and Month display indicator
4.25	Display of Voltage, Date (Year: Month), THDR % or Harmonic order number (Hd: 01 ~ Hd: 63)
4.26	U2: Indicates the display of voltage on phase 2(U2), THDR %, THDF % or Harmonic.
4.27	D-h: Day and hour display indicator
4.28	Display of Voltage, Date (Day: hour) or THDR %.
4.29	 Display of the rotary field direction
4.30	U3: Indicates display of voltage on phase 3, THDR %, THDF % or Harmonic.
4.31	m-s: minutes and seconds display indicator
4.32	Display of Voltage, Time (minutes:second) or THDR %.
4.33	A, I3, %: Units and indicator for phase 3 current, THDR %, THDF % or Harmonic.
4.34	1000A: Current range indicator
4.35	Display of current, time or THDF %
4.36	A, I2, %: Units and indicator for phase 2 current, THDR %, THDF % or Harmonic.
4.37	Display of current, date/time or THDF %
4.38	1000V: Voltage range indicator
4.39	A, I1, %: Units and indicator for phase 1 current, THDR %, THDF % or Harmonic.
4.40	Display of current, date or THDF %
4.41	STOP: Indicates the stop time for energy calculation

4.42	THDF: Voltage or current Total Harmonic Distortion of a waveform to its Fundamental indication.
4.43	INTV: Indicates the Auto data logging interval time setting
4.44	STAR: Indicates the start time for energy calculation
4.45	THDR: Voltage or current Total Harmonic Distortion of a waveform to the waveform RMS value indication.
4.46	TIME: Current data and time indicator.

5. OPERATING INSTRUCTION



CAUTION

- If possible, before connecting the meter to the electrical equipment to be tested, take off the electrical equipment's power.



DANGER

- Voltage input connectors U1 to U3 are common for input connector N, each input connectors are not insulated.
- Do not connect the unnecessary number of cords.



WARNING

- Always set up the measurement first, then connect the test leads to the circuit.
- Make connections to the instrument first, before connecting leads to a live circuit.
- Connect the ground lead first, then the voltage leads and the current probe, Disconnect in reverse order.
- Remove all test leads that are not in use.

※ **U1 must be connected to voltage source during the measurement of U2, U3, I1, I2 and I3, because U1 is the main signal source of the whole meter measuring system. Otherwise you could not have any measurement from U2, U3, I1, I2 and I3.**

5-1 AC Current Adaptor

Safety Information



Read First: Safety Information

To ensure safe operation and service of the current clamp, follow these instructions:

- Read the operating instructions before use and follow all safety instructions.
- Use the Current Clamp only as specified in the operating instructions, otherwise the clamp's safety features may not protect you.
- Adhere to local and national safety codes. Individual protective equipment must be used to prevent shock and arc blast injury where hazardous live conductors are exposed.
- Do not hold the Current Clamp anywhere beyond the tactile barrier, see Figure 1.
- Before each use, inspect the Current Clamp. Look for cracks or missing portions of the clamp housing or output cable insulation. Also look for loose or weakened components. Pay particular attention to the insulation surrounding the jaws.
- Never use the clamp on a circuit with voltages higher than 600V CAT III.
- Use extreme caution when working around bare conductor or bus bars. Contact with the conductor could result in electric shock.
- Use caution when working with voltages above 60V or 30V ac. Such voltages pose a shock hazard.



Warning

To avoid possible electric shock or personal injury:

- Before each use, inspect the Current Clamp. Look for cracks or missing portions of the clamp housing and output cable insulating cover and for loose or weakened components. Pay particular attention to the insulation surrounding the clamp jaws.
- Do not use a damaged Current Clamp. If a clamp is damaged, tape it shut to prevent unintended operation.

Measurement Considerations

- Center the conductor inside the Current Clamp jaw.
- Make sure the clamp is perpendicular to the conductor.
- For optimal reading, make sure the conductor is positioned between the alignment marks on the jaws of the Current Clamp.

Observe the following guidelines when making measurements :

- Avoid taking measurements close to other current carrying conductors.

Operation

To use the AC Current Adaptor, refer to “Measurement Considerations” and Figure 1.

1. Connect the clamp cable to the instrument.
2. The arrow on the top of the clamp must face towards the load of the circuit.
3. Connect the current clamp jaws around the conductor to be measured.



To avoid shock or personal injury, keep fingers behind the tactile barrier, see Figure 1.

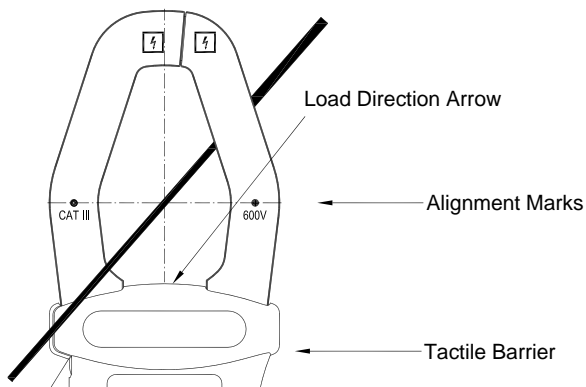

Figure 1

5-2 Single-Phase 2-Wire (1P2W) Power System Measurement

Application :

Receptacle branch circuit	Lighting loads
<ul style="list-style-type: none"> ● Troubleshooting electrical distribution system. 	<ul style="list-style-type: none"> ● Measuring current harmonic.
<ul style="list-style-type: none"> ● Measuring line rms voltage. 	<ul style="list-style-type: none"> ● Measuring power on single phase loads.
<ul style="list-style-type: none"> ● Measuring line rms current. 	
<ul style="list-style-type: none"> ● Measuring frequency. 	
<ul style="list-style-type: none"> ● Measuring voltage harmonics. 	
<ul style="list-style-type: none"> ● Measuring current harmonics. 	
<ul style="list-style-type: none"> ● Measuring voltage waveform (use PC). 	
<ul style="list-style-type: none"> ● Measuring current waveform (use PC) 	
<ul style="list-style-type: none"> ● Measuring the load on a transformer. 	
<ul style="list-style-type: none"> ● Recording the load on a transformer. 	

A: Line, N: Neutral, G: Ground, → Face the arrow toward the load.

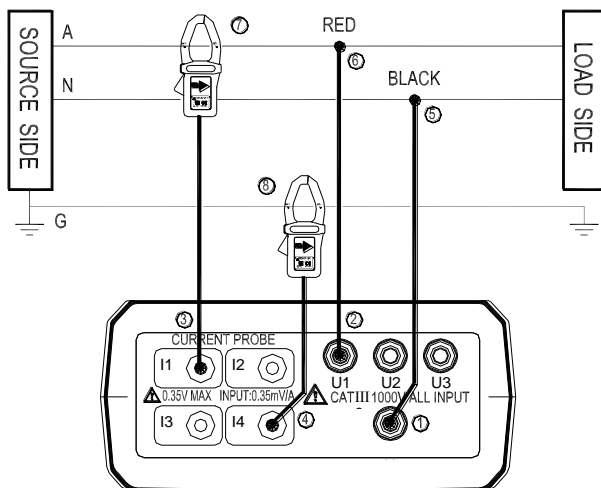

1P2W Wiring Connection Diagram

1. Press **ⓘ** key to turn on the meter.
2. Press **“WIRING”** key to select the 1P2W electrical system under test, the **“1P2W”** annunciator will be displayed.
3. Connect the voltage test leads and current probe to the meter.
 - ① Connect the black voltage test lead to the **“N”** terminal.
 - ② Connect the red voltage test lead to the **“U1”** terminal.
 - ③ Connect the I1 current probe output plug to the **“I1”** jack.
 - ④ If you want to measure ground leakage current, connect the I4 current probe output plug to the **“I4”** jack.
4. Connect the voltage test leads and current probe to the electrical equipment to be tested.



CAUTION

- If possible, before connecting the voltage test leads and current probe to the electrical equipment to be tested, take off the electrical equipment's power.

⑤ Connect the black voltage test alligator to the Neutral Line “**N**”.

⑥ Connect the red voltage test alligator to the Line “**A**”.

⑦ Press I1 current probe trigger to open the jaw and fully enclose the Line “**A**”.

⑧ If you want to measure ground leakage current, press I4 current probe the trigger to open the jaw and fully enclose the Ground Line “**G**”.

5. Frequency (Hz), Phase Angle (Θ), Ground Leakage Current (I4) and Power Factor (PF) measurement :

① Press “**PF Θ** ” key to cycle shows the PF and Θ measured values.

② Press “**Hz I4**” key to cycle shows the Hz and I4 measured values.

6. Voltage and Current THDR THDF measurement:

Please refer to section 4-1-12 “**THD**” key description.

7. Voltage and Current waveform harmonic measurement:

Please refer to section 4-1-25 “**||| MAG.**” key description.

8. Power Maximum/Minimum measurement:

Please refer to section 4-1-10 “**MAX**” key description.

9. Energy measurement:

- ① Press **“ENERGY”** key, the **“Pt”**, **“Qt”**, **“St”** and **“Pft”** or **“ψt”** annunciator and energy integrate start time are displayed. The energy integrate value and the current time will be continuous accumulate.
 - a). KW displays KWh
 - b). KVAR displays KVARh
 - c). KVA displays KVAh
- ② Press **“STOP”** key to stop energy accumulated and the **“HOLD”** annunciator is displayed.
- ③ Press **↵** key to exit the energy measurement.

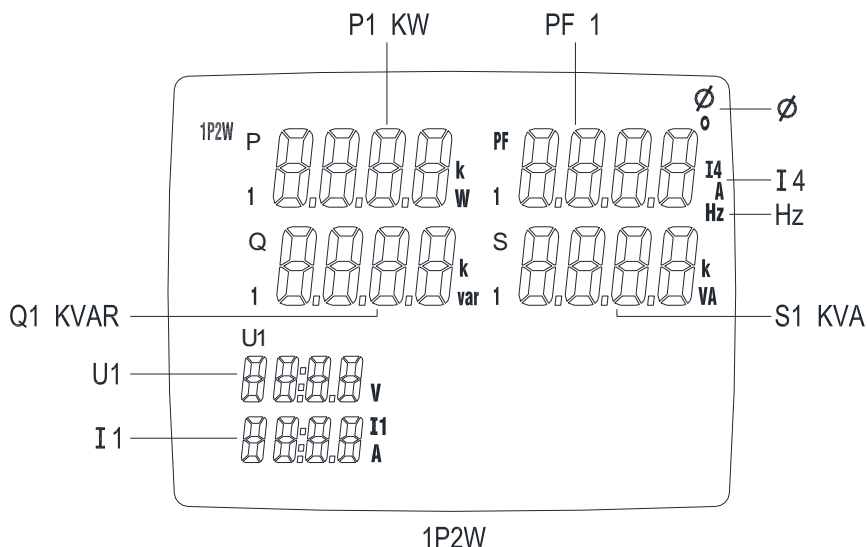

※ U1 must be connected to voltage source during the measurement of U2, U3, I1, I2 and I3, because U1 is the main signal source of the whole meter measuring system. Otherwise you could not have any measurement from U2, U3, I1, I2 and I3.

5-3 Single-Phase 3-Wire (1P3W) Power System Measurement

Application: Same as 1P2W power system measurement.

A, B: Line, N: Neutral, G: Ground, → Face the arrow toward the load.

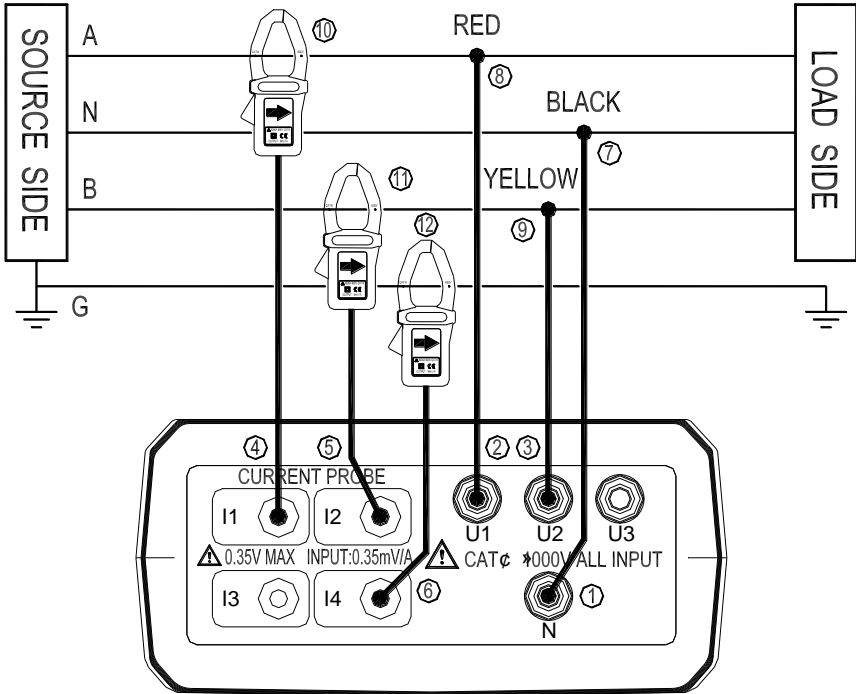

1P3W Wiring Connection Diagram

1. Press **ⓘ** key to turn on the meter.
2. Press **“WIRING”** key to select the 1P3W electrical system under test, the **“1P3W”** annunciator will be displayed.

3. Connect the voltage test leads and current probe to the meter.
 - ① Connect the black voltage test lead to the “**N**” terminal.
 - ② Connect the red voltage test lead to the “**U1**” terminal.
 - ③ Connect the yellow voltage test lead to the “**U2**” terminal.
 - ④ Connect the I1 current probe output plug to the “**I1**” jack.
 - ⑤ Connect the I2 current probe output plug to the “**I2**” jack.
 - ⑥ If you want to measure ground leakage current, connect the I4 current probe output plug to the “**I4**” jack.
4. Connect the voltage test leads and current probe to the electrical equipment to be tested.



CAUTION

- If possible, before connecting the voltage test leads and current probe to the electrical equipment to be tested, take off the electrical equipment's power.

- ⑦ Connect the black voltage test alligator to the neutral line “**N**”.
- ⑧ Connect the red voltage test alligator to the line “**A**”.
- ⑨ Connect the yellow voltage test alligator to the line “**B**”.
- ⑩ Press I1 current probe trigger to open the jaw and fully enclose the Line “**A**”.
- ⑪ Press I2 current probe trigger to open the jaw and fully enclose the Line “**B**”.



- ⑫ If you want to measure ground leakage current, press I4 current probe trigger to open the jaw and fully enclose the ground line “**G**”.
5. Press “**▲POWER▼**” key to select (P1, Q1, S1, PF1), (P2, Q2, S2, PF2) and (Pt, Qt, St, PFt) measured values.
6. Frequency (Hz), Phase Angle (Θ), Ground Leakage Current (I4) and Power Factor (pF) measurement :
 - ① Press “**PF Θ** ” key to cycle shows the PF and Θ measured values.
 - ② Press “**Hz I4**” key to cycle shows the Hz and I4 measured values.
7. Voltage and Current THDR THDF measurement:

Please refer to section 4-1-12 “**THD**” key description.
8. Voltage and Current waveform harmonic measurement:

Please refer to section 4-1-25 “**||| MAG.**” key description.
9. Power Maximum/Minimum measurement:

Please refer to section 4-1-10 “**MAX**” key description.
10. Energy measurement:
 - ① Press “**ENERGY**” key, the “**Pt**”, “**Qt**”, “**St**” and “**PFt**” or “ **ψ t**” annunciator and energy integrate start time are displayed. The energy integrate value and the current time will be continuous accumulate.
 - a). KW displays KWh
 - b). KVAR displays KVARh
 - c). KVA displays KVAh
 - ② Press “**STOP**” key to stop energy accumulated and the “**HOLD**” annunciator is displayed.

③ Press \downarrow key to exit the energy measurement.

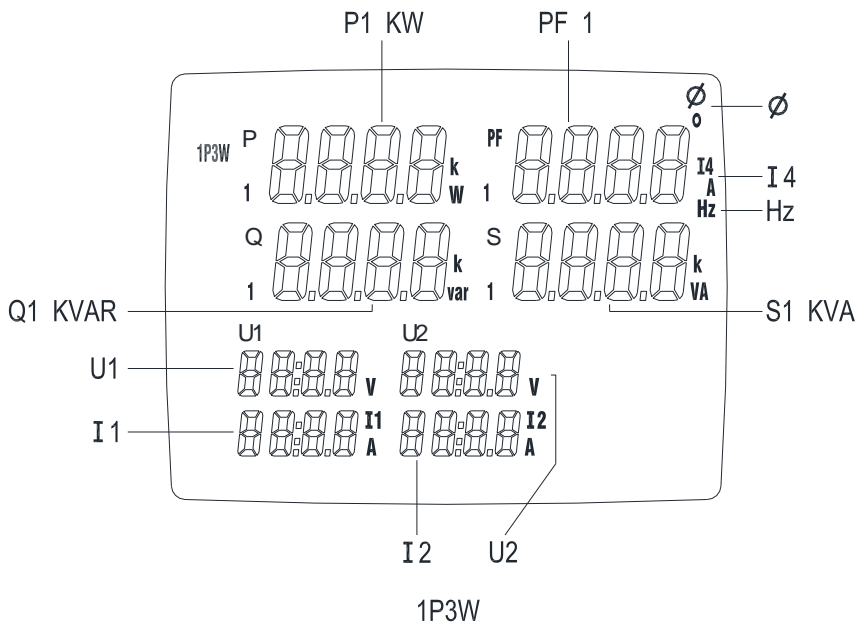

※ U1 must be connected to voltage source during the measurement of U2, U3, I1, I2 and I3, because U1 is the main signal source of the whole meter measuring system. Otherwise you could not have any measurement from U2, U3, I1, I2 and I3.



5-4 Three-Phase 3-Wire (3P3W2M) Power System Measurement

Using 2 power meter method

Application :

Induction motors without adjustable speed drive.	Induction motors with adjustable speed drive.
● Checking voltage unbalance.	● Checking current on phases.
● Checking current and current unbalance.	● Measuring frequency of motor current.
● Measuring power in 3-phase balanced and unbalanced system.	
● Measuring power factor of 3-phase motors.	
● Measuring voltage harmonics (use PC).	

Unbalance factor:

When the load of the specified phase becomes too heavy due to fluctuations in loads connected to each power line phases, or when operating on uneven device, the voltage and current waveforms become distorted, causing voltage drops, they can cause voltage unbalance, reverse phase to neutral voltage, and harmonics may cause accidents such as uneven motor rotation, circuit breaker trips, and over load heating in the transformer.

A, B, C: Line, → Face the arrow toward the load.

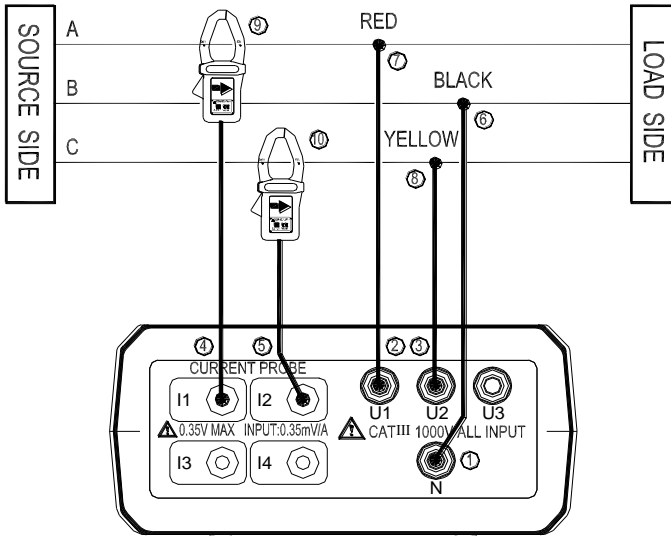

3P3W2M Wiring Connection Diagram

1. Press **ⓘ** key to turn on the meter.
2. Press **“WIRING”** key to select the 3P3W2M electrical system under test, the **“3P3W2M”** annunciator will be displayed.
3. Connect the voltage test leads and current probe to the meter.
 - ① Connect the black voltage test lead to the **“N”** terminal.
 - ② Connect the red voltage test lead to the **“U1”** terminal.
 - ③ Connect the yellow voltage test lead to the **“U2”** terminal.
 - ④ Connect the I1 current probe output plug to the **“I1”** jack.
 - ⑤ Connect the I2 current probe output plug to the **“I2”** jack.
4. Connect the voltage test leads and current probe to the electrical

equipment to be tested.



CAUTION

- If possible, before connecting the voltage test leads and current probe to the electrical equipment to be tested, take off the electrical equipment's power.

- ⑥ Connect the black voltage test alligator to the line “**B**”.
 - ⑦ Connect the red voltage test alligator to the line “**A**”.
 - ⑧ Connect the yellow voltage test alligator to the line “**C**”.
 - ⑨ Press I1 current probe trigger to open the jaw and fully enclose the Line “**A**”.
 - ⑩ Press I2 current probe trigger to open the jaw and fully enclose the Line “**C**”.
5. Press “**▲POWER▼**” key to select (P1, Q1, S1, PF1), (P2, Q2, S2, PF2) and (Pt, Qt, St, PFt) measured values.
6. Frequency (Hz), Phase Angle (Θ) and Power Factor (pF) measurement:
- ① Press “**PFO**” key to cycle shows the PF and Θ measured values.
 - ② Press “**Hz I4**” key show the Hz measured value.
7. Voltage and Current THDR THDF measurement:
- Please refer to section 4-1-12 “**THD**” key description.
8. Voltage and Current waveform harmonic measurement:
- Please refer to section 4-1-25 “**||| MAG.**” key description.
9. Power Maximum/Minimum measurement:

Please refer to section 4-1-10 “**MAX**” key description.

10. Energy measurement:

- ① Press “**ENERGY**” key, the “Pt”, “Qt”, “St” and “PFt” or “**ψt**” annunciator and energy integrate start time are displayed. The energy integrate value and the current time will be continuous accumulate.
 - a). KW displays KWh
 - b). KVAR displays KVARh
 - c). KVA displays KVAh
- ② Press “**STOP**” key to stop energy accumulated and the “**HOLD**” annunciator is displayed.
- ③ Press ↵ key to exit the energy measurement.

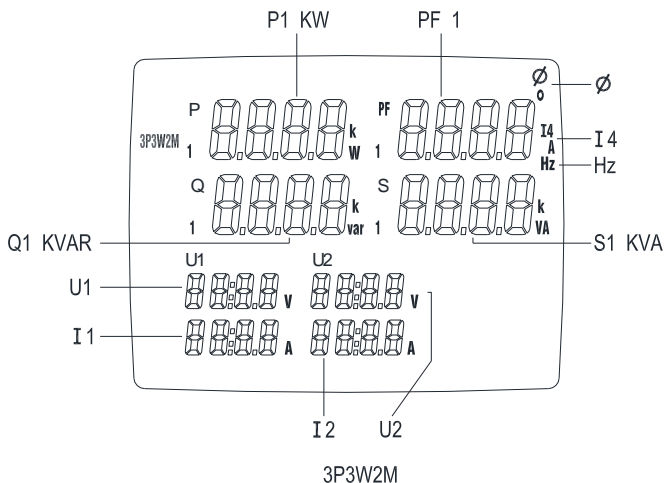

5-5 Three-Phase 3-Wire (3P3W3M) Power System Measurement

Application : Same as 3P3W power system measurement.

A, B, C: Line, → Face the arrow toward the load.

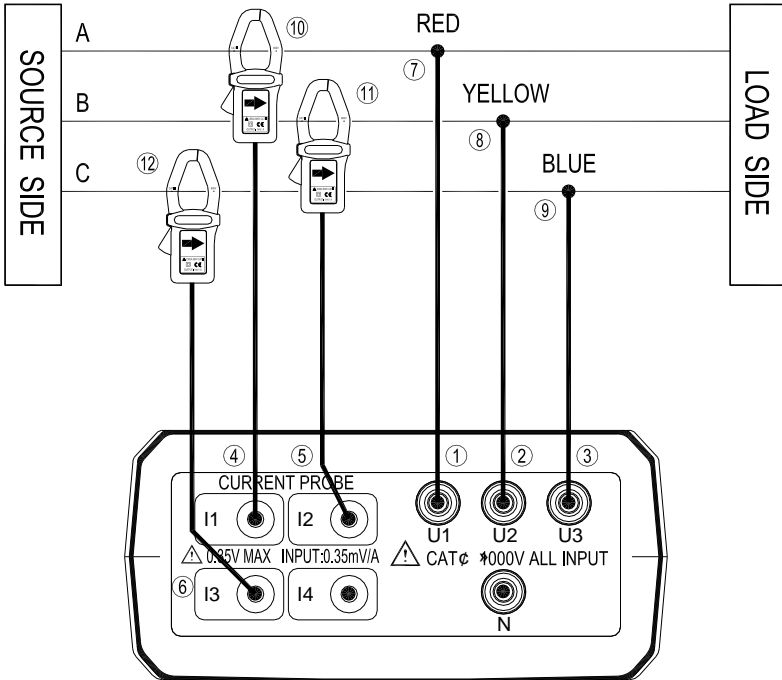

3P3W3M Wiring Connection Diagram

1. Press **ⓘ** key to turn on the meter.
2. Press **“WIRING”** key to select the 3P3W3M electrical system under test, the **“3P3W3M”** annunciator will be displayed.
3. Connect the voltage test leads and current probe to the meter.

- ① Connect the red voltage test lead to the “U1” terminal.
- ② Connect the yellow voltage test lead to the “U2” terminal.
- ③ Connect the blue voltage test lead to the “U3” terminal.
- ④ Connect the I1 current probe output plug to the “I1” jack.
- ⑤ Connect the I2 current probe output plug to the “I2” jack.
- ⑥ Connect the I3 current probe output plug to the “I3” jack.

4. Connect the voltage test leads and current probe to the electrical equipment to be tested.



CAUTION

- If possible, before connecting the voltage test leads and current probe to the electrical equipment to be tested, take off the electrical equipment's power.

- ⑦ Connect the red voltage test alligator to the line “A”.
 - ⑧ Connect the yellow voltage test alligator to the line “B”.
 - ⑨ Connect the blue voltage test alligator to the line “C”.
 - ⑩ Press I1 current probe trigger to open the jaw and fully enclose the Line “A”.
 - ⑪ Press I2 current probe trigger to open the jaw and fully enclose the Line “B”.
 - ⑫ Press I3 current probe trigger to open the jaw and fully enclose the Line “C”.
5. Press “▲POWER▼” key to select (P1, Q1, S1, PF1), (P2, Q2, S2, PF2), (P3, Q3, S3, PF3) and (Pt, Qt, St, PFt) measured values.
6. Frequency (Hz), Phase Angle (Θ) and Power Factor (pF) measurement:
- ① Press “PFO” key to cycle shows the PF and Θ measured values.
 - ② Press “Hz I4” key show the Hz measured value.
7. Voltage and Current THDR THDF measurement:
- Please refer to section 4-1-12 “THD” key description.
8. Voltage and Current waveform harmonic measurement:

Please refer to section 4-1-25 “**MAG.**” key description.

9. Power Maximum/Minimum measurement:

Please refer to section 4-1-10 “**MAX**” key description.

10. Energy measurement:

- ① Press “**ENERGY**” key, the “**Pt**”, “**Qt**”, “**St**” and “**Pft**” or “**ψt**” annunciator and energy integrate start time are displayed. The energy integrate value and the current time will be continuous accumulate.
 - a). KW displays KWh
 - b). KVAR displays KVARh
 - c). KVA displays KVAh
- ② Press “**STOP**” key to stop energy accumulated and the “**HOLD**” annunciator is displayed.
- ③ Press \downarrow key to exit the energy measurement.

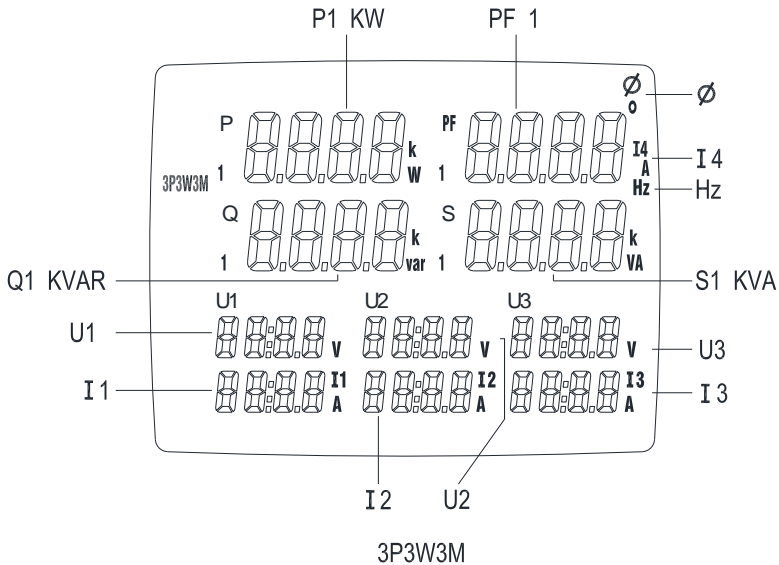

5-6 Three-Phase 4-Wire (3P4W) Power System Measurement

Application: Same as 3P3W power system measurement.

A, B, C: Line, N: Neutral, G: Ground, → Face the arrow toward the load.

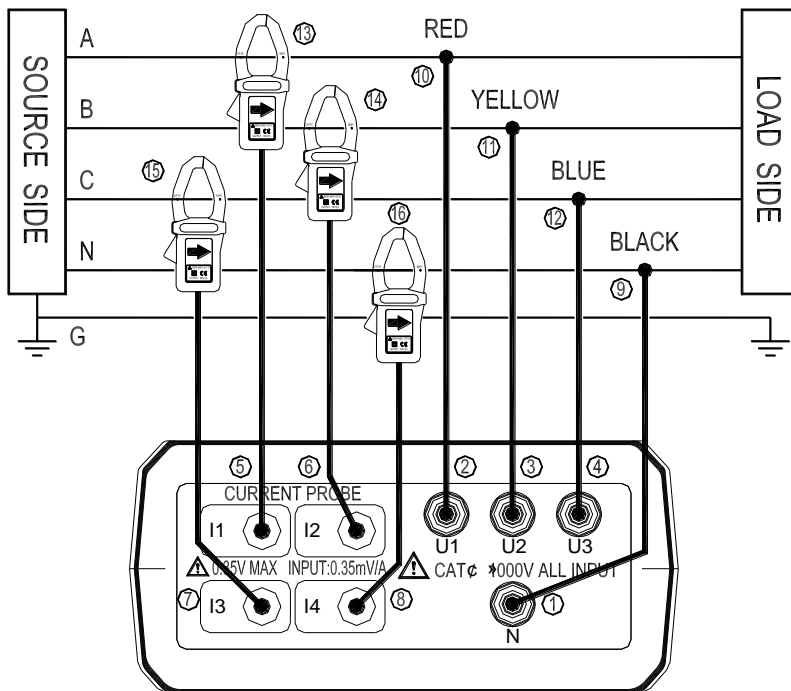

3P4W Wiring Connection Diagram

1. Press **ⓘ** key to turn on the meter.
2. Press **“WIRING”** key to select the 3P4W electrical system under test, the **“3P4W”** annunciator will be displayed.
3. Connect the voltage test leads and current probe to the meter.

User Manual

- ① Connect the black voltage test lead to the “N” terminal.
 - ② Connect the red voltage test lead to the “U1” terminal.
 - ③ Connect the yellow voltage test lead to the “U2” terminal.
 - ④ Connect the blue voltage test lead to the “U3” terminal.
 - ⑤ Connect the I1 current probe output plug to the “I1” jack.
 - ⑥ Connect the I2 current probe output plug to the “I2” jack.
 - ⑦ Connect the I3 current probe output plug to the “I3” jack.
 - ⑧ Connect the I4 current probe output plug to the “I4” jack.
4. Connect the voltage test leads and current probe to the electrical equipment to be tested.



CAUTION

- If possible, before connecting the voltage test leads and current probe to the electrical equipment to be tested, take off the electrical equipment's power.

- ⑨ Connect the black voltage test alligator to the neutral line “N”.
 - ⑩ Connect the red voltage test alligator to the line “A”.
 - ⑪ Connect the yellow voltage test alligator to the line “B”.
 - ⑫ Connect the blue voltage test alligator to the line “C”.
 - ⑬ Press I1 current probe trigger to open the jaw and fully enclose the Line “A”.
 - ⑭ Press I2 current probe trigger to open the jaw and fully enclose the Line “B”.
 - ⑮ Press I3 current probe trigger to open the jaw and fully enclose the Line “C”.
 - ⑯ Press I4 current probe trigger to open the jaw and fully enclose neutral line “N”.
5. Press “▲POWER▼” key to select (P1, Q1, S1, PF1), (P2, Q2, S2, PF2), (P3, Q3, S3, PF3) and (Pt, Qt, St, PFt) measured values.
6. Frequency (Hz), Phase Angle (Θ), Neutral Line Current (I4) and Power Factor (pF) measurement :
- ① Press “PFΘ” key to cycle shows the PF and Θ measured values.

5-7 Only One Current I4 Measurement

Application: Measurement any wire current independent of voltage, the same as clamp meter application.

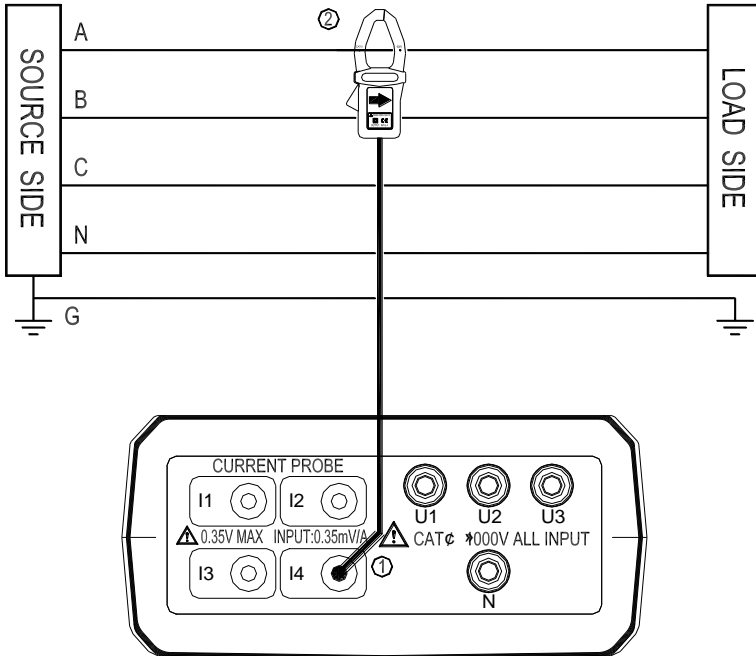

1. Press **ⓘ** key to turn on the meter.
2. Press “**I4**” key.
3. Connect the I4 current probe output plug to the “**I4**” jack.
4. Press I4 current probe trigger to open the jaw and fully enclose desired measured wire.
5. Read the I4 value.

5-8 Manual Data Memory and Read Function Operation

1. Clear Manual memory data:

- ① Press **I** key to turn off the meter.
- ② Press and hold down the “**MEMORY**” key then press **I** key again to turn on the meter and to enter clear manual memory data mode, the “**DATA M CLr 1 YES no**” mark is displayed.
- ③ Press **◀** or **▶** key to select “**YES**” or “**no**” then press **↵** key to confirm.
If select “**YES**”, the all manual memorized data is cleared.

2. Store Manual data to memory:

- ① Press “**MEMORY**” key one time store one sets displayed data to memory, the “**M**” annunciator display one time and the stored memory address will be displayed.
- ② Maximum store memory capacity size is 50 sets.

3. Read the manual stored data:

- ① Press “**READ**” key to enter the read mode, the “**R**” annunciator is displayed.
- ② Press **▲▼** key to read the memories data, the memories data address will be displayed.
- ③ Press “**READ**” key to exit the read mode.

5-9 Auto Datalogging Function Operation

1. Clear SD Card memory data:

- ① Press **ⓘ** key to turn off the meter.
- ② Press and hold down the “**MEMORY**” key then press **ⓘ** key again to turn on the meter and to enter clear manual memory data mode, the “**DATA M CLr 1 YES no**” mark is displayed.
- ③ Press **↵** key to enter clear SD Card memory data mode, the “**DATA M CLr 2 YES no**” mark is displayed.
- ④ Press **◀** or **▶** key to select “**YES**” or “**no**” then press **↵** key to confirm.
If select “**YES**”, the all SD Card memorized data is cleared.

2. Store Auto datalogging data to memory:

■ **Setting the current time and Auto datalogging interval time.**

- ① Press “**SET**” key to enter current time setting mode.
- ② Press **▲▼◀▶** keys to set actual current YEAR-month, DAY-hour, minute-second.
- ③ Press **↵** key to enter auto datalogging interval time setting, the “**INTV**” annunciator is displayed.
- ④ Press **▲▼** keys cycle select the interval time, you can select 5 seconds, 10 seconds, 30 seconds, 1 minute or 2 minutes.
- ⑤ Press **↵** key to exit TIME setting mode.

■ Enter Auto datalogging mode.

- ① Press “**START**” key to start Auto data logging, the “**DATA Mxx**” will be displayed, the “**M**” annunciator, according to the interval time disappear one time store one sets data into the memory.
- ② Press “**STOP**” key to stop data record, press “**START**” key will resume data record, but maximum can be divide to 99 memory blocks, the current block number will be displayed (01 ~ 99).
- ③ When maximum block or maximum capacity is full, the “**DATA FULL**” annunciator will be displayed, the data record is auto stopped.

■ Download data to PC

Please refer to the software manual (CD-ROM) to download the data.





5-10 Phase Sequence Measurement

1. Press  key to turn on the meter.
2. Press “**WIRING**” key to select 3P4W mode.
3. Connect the voltage test leads to the meter.
 - ① Connect the red voltage test lead to the “**U1**” terminal.
 - ② Connect the yellow voltage test lead to the “**U2**” terminal.
 - ③ Connect the blue voltage test lead to the “**U3**” terminal.
4. Connect the voltage test leads to the electrical equipment to be tested.



CAUTION

- If possible, before connecting the voltage test leads and current probe to the electrical equipment to be tested, take off the electrical equipment's power.

- ① Connect the red voltage test alligator to the power line “**A**” phase.
 - ② Connect the yellow voltage test alligator to the power line “**B**” phase.
 - ③ Connect the blue voltage test alligator to the power line “**C**” phase.
5. U1, U2 and U3 measured voltage must be greater than 30V, then press and hold down “” key. If connection wires is normal phase, the “” annunciator is displayed. If connection wires is reverse phase, the “” annunciator is displayed. Release the “” key to exit this measurement.

5-11 Voltage, Current Waveform and Harmonic Analyzer

Application:



May device power sources now use semiconductor control devices and harmonics occur because of distorted voltage or current wave forms.

When harmonic components become too large, they can cause serious accidents, such as transformer supplying seeming average loads are overheating, neutral conductors in balanced circuit are overheating from excessing loads, circuit breakers are tripping for no apparent reason, overheating the motor or burning out the reactor connected to the phase advance capacitor. Please refer to software manual (CD-ROM) for waveform and harmonic measurement.

5-12 Enable Auto Power Off Function

When enable auto power off function, the meter will automatically enter sleep mode approx. 30 minutes to save power consumption.

1. Enable auto power off procedure:

- ① Press  key to turn off the meter.
- ② Press and hold down “**TIME**” key, then press  key to turn on the meter, the auto power function will be enabled, and the auto power off symbol “” will be appear.

2. Auto power off mode is disabled each time you turn on the meter and is automatically disabled as the follow modes.

- ① ENERGY function is active.



- ② Auto datalogging function is active.
- ③ PC linked.

6. MAINTENANCE

6-1 General Maintenance



1. Repairs or services that are not covered in this manual should only be performed by qualified personnel.
2. Clean the meter and accessories with a damp cloth and a mild soap. Do not use abrasives, solvent, or alcohol. These may damage the text.
3. Additional to this it is recommended to open the jaws of the Current Clamp and to wipe the magnetic pole pieces with a lightly oiled cloth. This in order to avoid rust or corrosion to form on the magnetic poles.

6-2 Battery Replacement



WARNING

- To AVOID electrical shock, remove the test leads and current probe before replacing the batteries.

1. As battery power is not sufficient, LCD will display  annunciator, replace new battery is required.
2. Disconnect all test leads and current probe from any power electrical source, press  key to turn off the meter, and remove the test leads from the jacks.
3. The battery cover is secured to the bottom case by two screws. Using a screw driver to remove the two screws from the bottom case.

4. Remove battery cover, take out the batteries and replace with new batteries. (Please note battery polarity)

7. SOFTWARE INSTALLATION AND OPERATION

7-1 RS232 Wiring Hardware

PC Interface Cable Meter side of PC Interface Cable The RS-232 “Optical” plug side of the PC Interface Cable connects to the meter’s RS-232 “Optical” jack. Refer to the diagram below for wiring information.

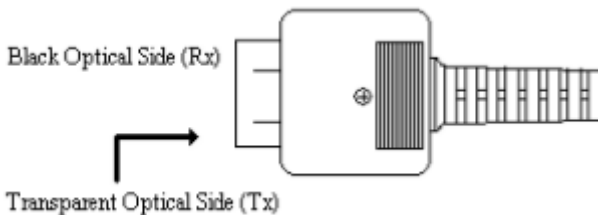

Computer’s Serial Port side of Interface Cable

The RS-232 “DB-9” side of the PC Interface Cable connects to the PC’s COM port. Refer to the diagram below for wiring information. Note that a SERIAL to USB Adapter may be used.



RS232 Default Settings When RS-232 communication enabled, the default RS-232 settings are:

- Baud Rate 19200
- Parity None
- Data bits 8
- Stop bit 1

7-1 HARDWARE REQUIREMENTS AND SETUP

PC HardWare Requirements :

HDD, CD Rom, 486 PC or above, with an available COM port
EGA or higher monitor
4M bytes or more memorysize

PC HardWare Setup :

- 1) Switch off all power related to the PC
- 2) Connect the DB9 (female) end of the supplied RS-232 cable to available COM port
- 3) Switch on all related power
- 4) Connect the fiber end of the supplied RS-232 cable to the meter

7-3 Software Requirements and Setup

- 1) Start up windows 98//XP//7//8//10 operating system
- 2) Close all other application
- 3) Insert disk in CD drive

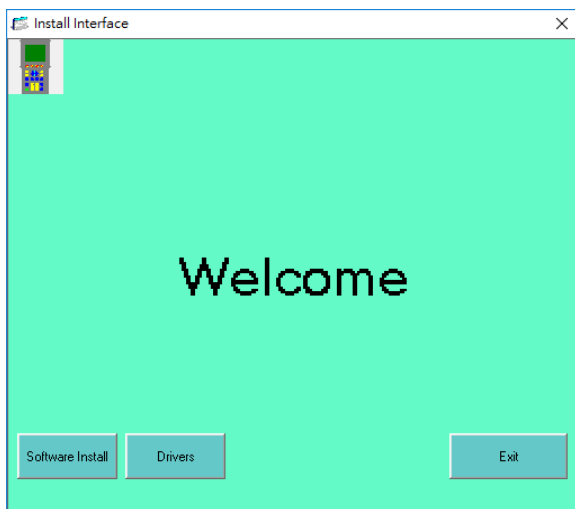

- 4) To install USB driver, click



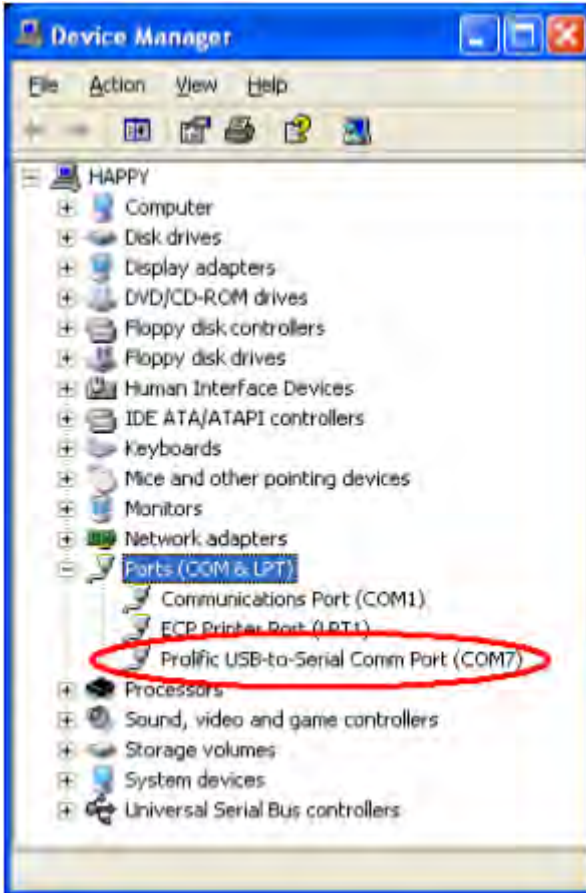

Software Install

5) To install meter software, Click Software Install. Setup program will run

automatically.

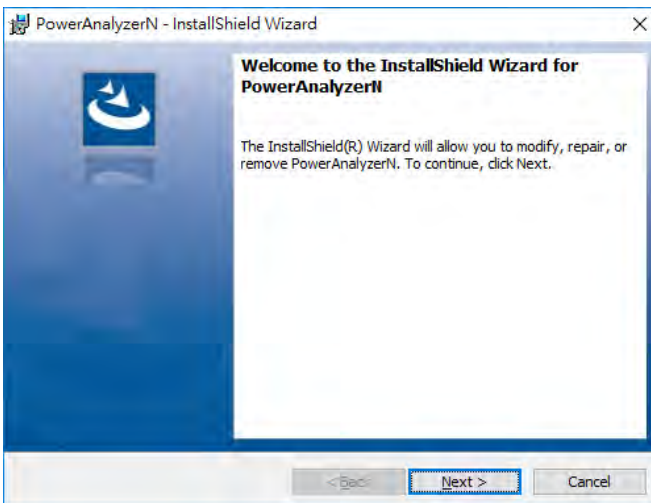
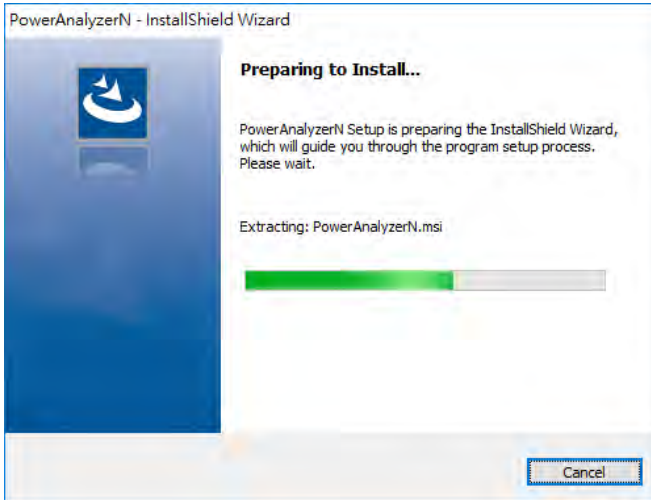

Click "Next"

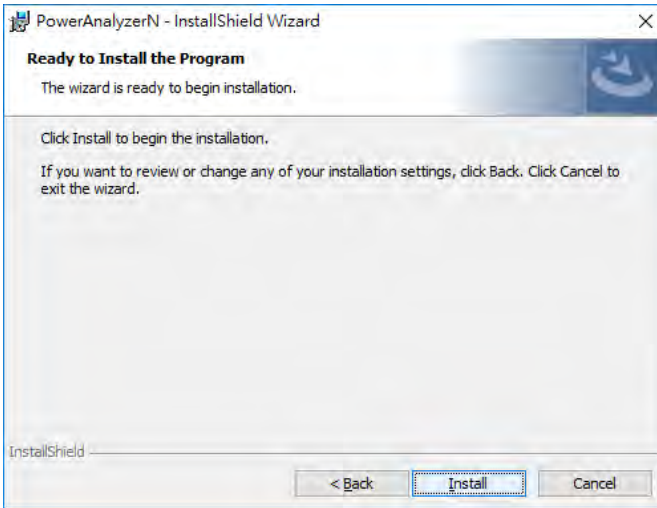

3.

Click “Install”

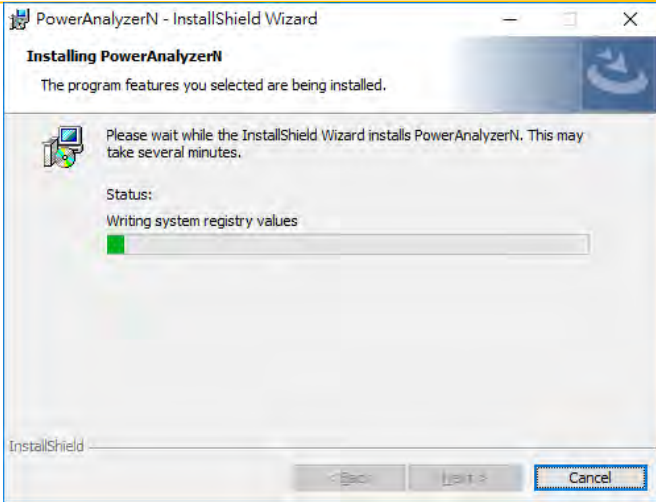

4.

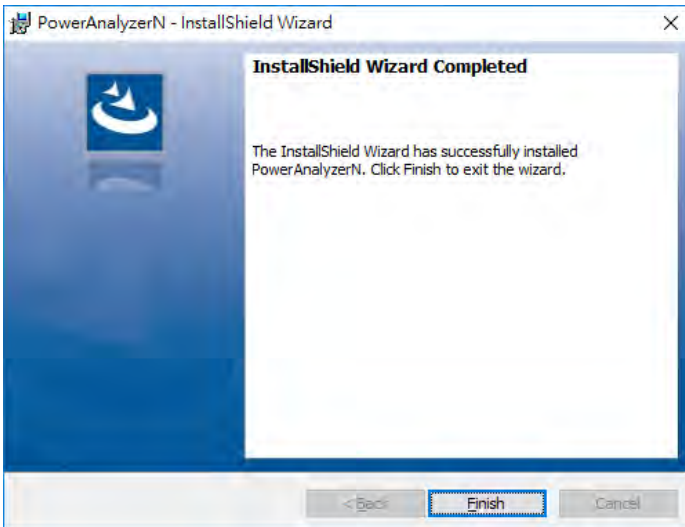

5.

Click "Finish"

7-4 Communication Operation

Run the software

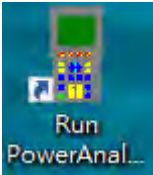

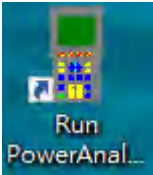
1. Click  icon.

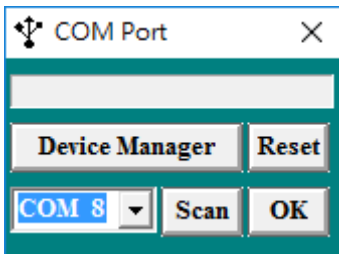

Select as available COM Port then click OK

2. Main software screen

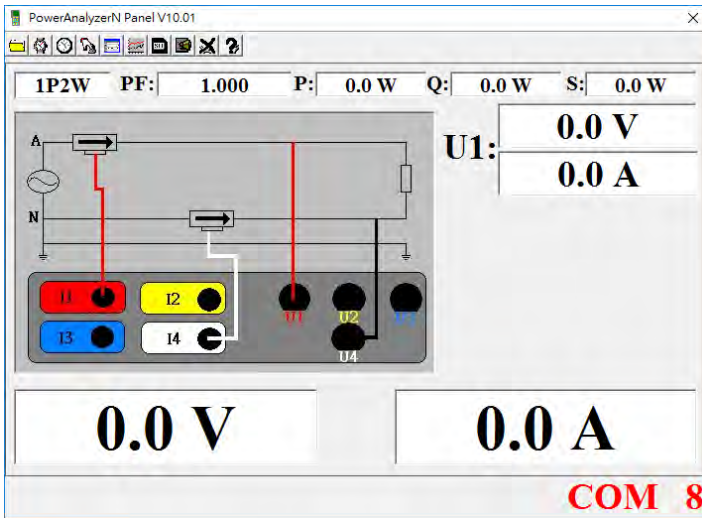

7-5 Data Record

Save to H.D.D.

Click  button. The dialog box shown below will appear.

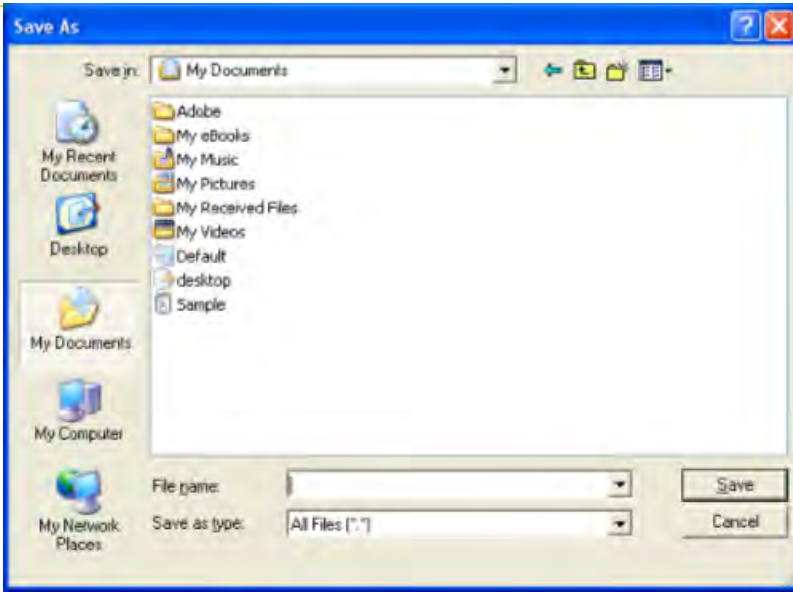

Input a file name and then Click  to begin saving data to the file just named.

7-6 Download data

Click  button. The Open window, shown below, appears.

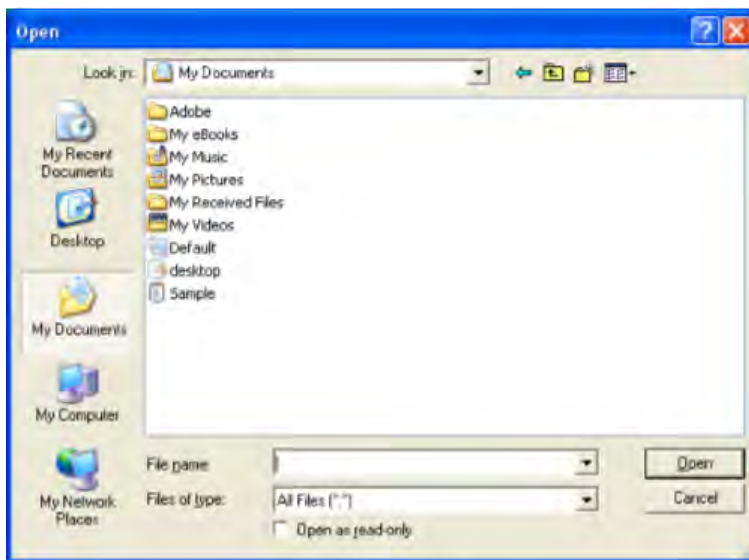

Input the file that was selected earlier and the click  to read.

7-7 SD Card

Click  button. The Data Logger window, shown below, will open.

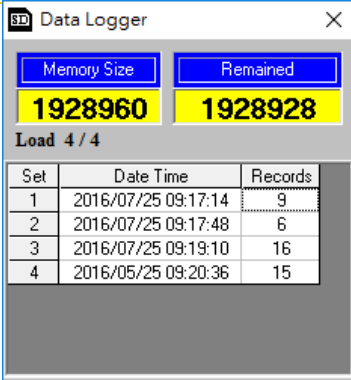

Data Logger

Memory Size: **1928960** Remained: **1928928**

Load 4 / 4

Set	Date Time	Records
1	2016/07/25 09:17:14	9
2	2016/07/25 09:17:48	6
3	2016/07/25 09:19:10	16
4	2016/05/25 09:20:36	15

Click on a SET number to view the set's details. For example, in the window above, there are 2 sets from which to choose. The list below is an example of an opened set.

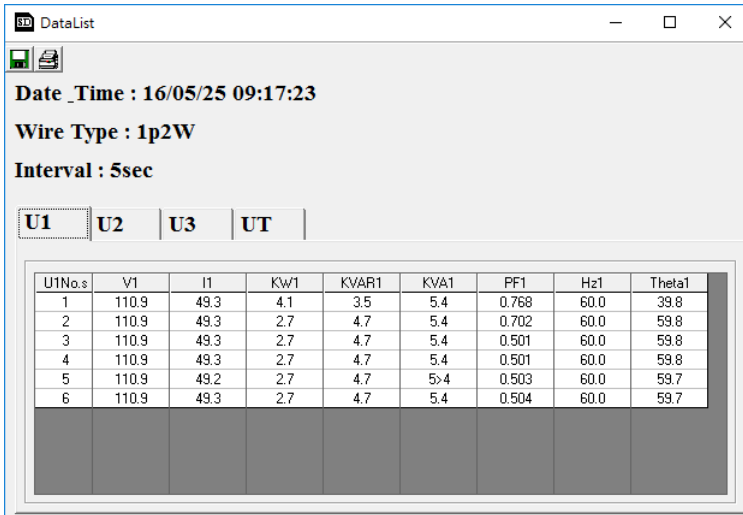

DataList

Date_Time : 16/05/25 09:17:23

Wire Type : 1p2W

Interval : 5sec

U1 **U2** **U3** **UT**

U1No.s	V1	I1	KW1	KVAR1	KVA1	PF1	Hz1	Theta1
1	110.9	49.3	4.1	3.5	5.4	0.768	60.0	39.8
2	110.9	49.3	2.7	4.7	5.4	0.702	60.0	59.8
3	110.9	49.3	2.7	4.7	5.4	0.501	60.0	59.8
4	110.9	49.3	2.7	4.7	5.4	0.501	60.0	59.8
5	110.9	49.2	2.7	4.7	5.4	0.503	60.0	59.7
6	110.9	49.3	2.7	4.7	5.4	0.504	60.0	59.7

7-8 Data Convert

Apply for Excel

User Manual

Open Microsoft Excel, find the file saved, for example 3600N.pan

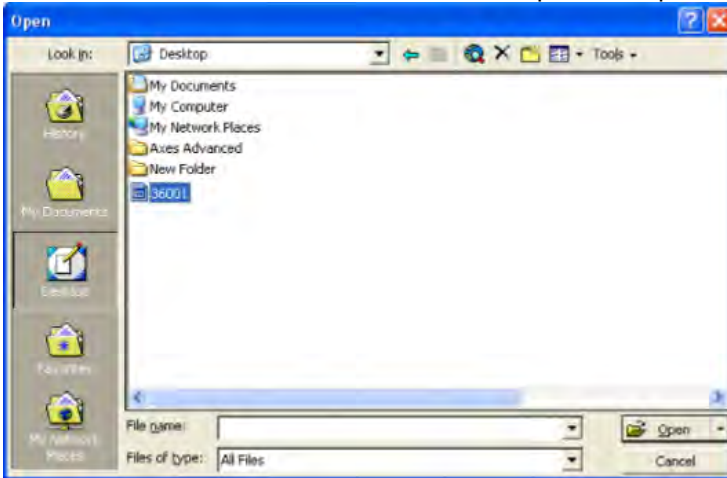

The "Text Import Wizard" then appears. Follow on-screen instructions.

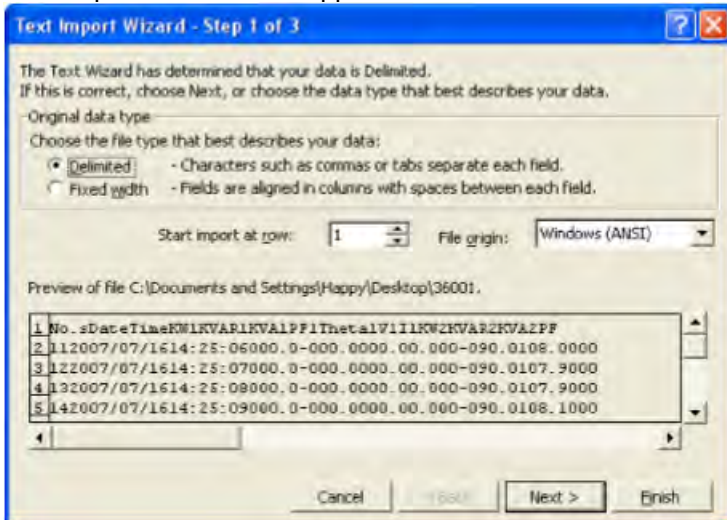

Click

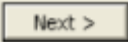

7-9 Apply for Graph

Open a saved data file in the software program and then click .

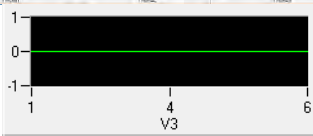
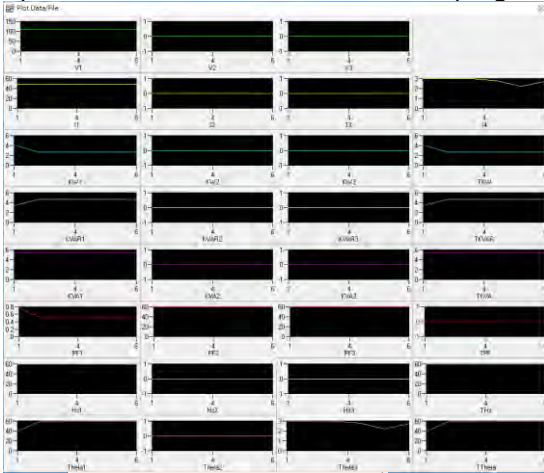

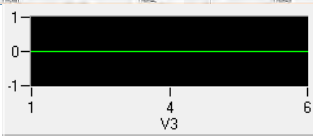
Click  graphic.

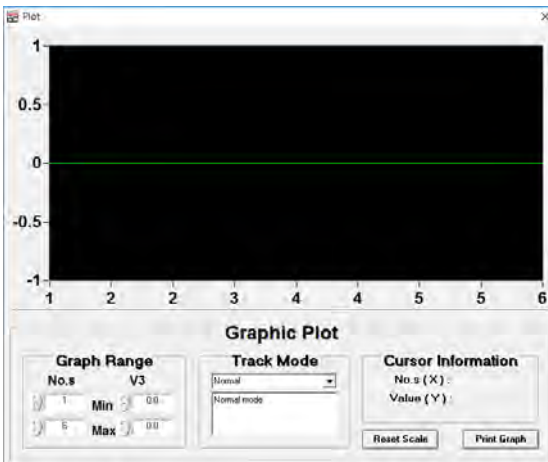

7-10 Sampling Time

PC Sampling Rate:

(rate at which the PC collects readings while connected to the meter)

Click  on the Menu Bar.

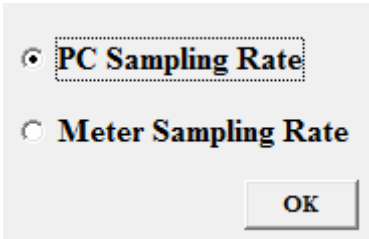

Click  button.

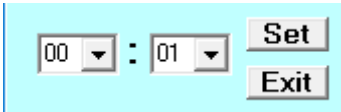

Click  button.

Meter Sampling Rate:

Click  on the Menu Bar.

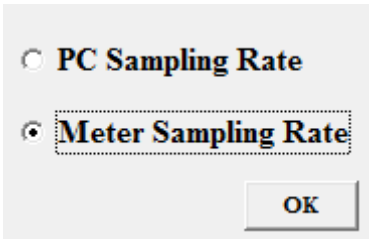

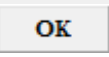
Click  button.



Click  button.

7-11 RTC (Real Time Clock)

Click  on the **Menu Bar** to set the meter time to PC system time.

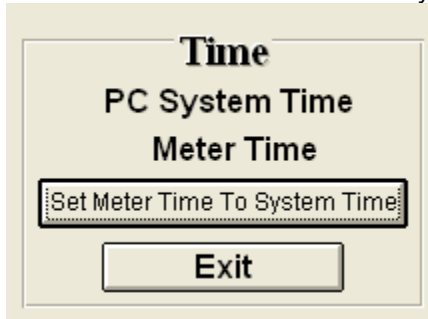

Click **PC System Time** to show PC System Time or **Meter Time** to show Meter Time.

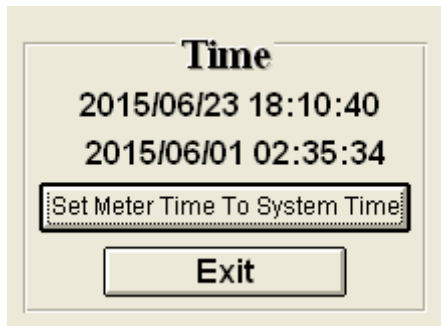

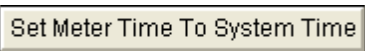
Click  to set the meter time to PC system time.

7-12 SingleRecord

Click  button, On Menu Bar.

Single Record ×

Print Wire Type: 1P2w

Date Time : 16/05/25 09:16:11

<input type="text" value="1"/>	U1	U2	U3	I4
Electric Current	49.3	0.0	0.0	2.7
Voltage	110.9	0.0	0.0	Total
P	2.7	0.0	0.0	2.7
Q	4.7	0.0	0.0	4.7
S	5.4	0.0	0.0	5.4
PF	0.503	0.000	0.000	0.000
Hz	60.0	60.0	60.0	60>0
Theta	79.7	0.0	0.0	59.7

Click  button. Print form page.

Contact

You can read our Contact terms in our General Business Terms which you can find here: <https://www.pce-instruments.com/english/terms>.

DISPOSAL

For the disposal of batteries in the EU, the 2006/66/EC directive of the European Parliament applies. Due to the contained pollutants, batteries must not be disposed of as household waste. They must be given to collection points designed for that purpose.

In order to comply with the EU directive 2012/19/EU we take our devices back. We either re-use them or give them to a recycling company which disposes of the devices in line with law.

For countries outside the EU, batteries and devices should be disposed of in accordance with your local waste regulations.

If you have any questions, please contact PCE Instruments.



PCE Instruments contact information

Germany

PCE Deutschland GmbH
Im Langel 4
D-59872 Meschede
Deutschland
Tel.: +49 (0) 2903 976 99 0
Fax: +49 (0) 2903 976 99 29
info@pce-instruments.com
www.pce-instruments.com/deutsch

France

PCE Instruments France EURL
76, Rue de la Plaine des Bouchers
67100 Strasbourg
France
Téléphone: +33 (0) 972 3537 17
Numéro de fax: +33 (0) 972 3537 18
info@pce-france.fr
www.pce-instruments.com/french

Spain

PCE Ibérica S.L.
Calle Mayor, 53
02500 Tobarra (Albacete)
España
Tel. : +34 967 543 548
Fax: +34 967 543 542
info@pce-iberica.es
www.pce-instruments.com/espanol

United States of America

PCE Americas Inc.
711 Commerce Way suite 8
Jupiter / Palm Beach
33458 FL
USA
Tel: +1 (561) 320-9162
Fax: +1 (561) 320-9176
info@pce-americas.com
www.pce-instruments.com/us

United Kingdom

PCE Instruments UK Ltd
Unit 11 Southpoint Business Park
Ensign Way, Southampton
Hampshire
United Kingdom, SO31 4RF
Tel: +44 (0) 2380 98703 0
Fax: +44 (0) 2380 98703 9
info@industrial-needs.com
www.pce-instruments.com/english

Italy

PCE Italia s.r.l.
Via Pesciatina 878 / B-Interno 6
55010 LOC. GRAGNANO
CAPANNORI (LUCCA)
Italia
Telefono: +39 0583 975 114
Fax: +39 0583 974 824
info@pce-italia.it
www.pce-instruments.com/italiano

The Netherlands

PCE Brookhuis B.V.
Institutenweg 15
7521 PH Enschede
Nederland
Telefoon: +31 (0) 900 1200 003
Fax: +31 53 430 36 46
info@pcebenelux.nl
www.pce-instruments.com/dutch

Chile

PCE Instruments Chile SPA
RUT 76.423.459-6
Badajoz 100 oficina 1010 Las Condes
Santiago de Chile / Chile
Tel. : +56 2 24053238
Fax: +56 2 2873 3777
info@pce-instruments.cl
www.pce-instruments.com/chile

Hong Kong

PCE Instruments HK Ltd.
Unit J, 21/F., COS Centre
56 Tsun Yip Street
Kwun Tong
Kowloon, Hong Kong
Tel: +852-301-84912
jyi@pce-instruments.com
www.pce-instruments.cn

China

Pingce (Shenzhen) Technology Ltd.
West 5H1,5th Floor,1st Building
Shenhua Industrial Park,
Meihua Road,Futian District
Shenzhen City
China
Tel: +86 0755-32978297
lko@pce-instruments.cn
www.pce-instruments.cn

Turkey

PCE Teknik Cihazları Ltd.Şti.
Halkalı Merkez Mah
Pehlivan Sok. No.6/C
34303 Küçükçekmece - İstanbul
Türkiye
Tel: 0212 471 11 47
Faks: 0212 705 53 93
info@pce-cihazlari.com.tr
www.pce-instruments.com/turkish

