











SYMBOLS showed on the clamp meter or in this manual:

	Caution, risk of danger. Refer to accompanying documents
	Caution, risk of electric shock.
	Double Insulation
	Application around and removal from HAZARDOUS LIVE conductors is permitted.
	Earth (ground)
	AC (Alternating Current)
	DC (Direct Current)
	Both direct and alternating current
	Conforms to relevant European Union directives.
	Do not dispose of this clamp meter as unsorted municipal waste. Contact a qualified recycler for disposal.



EN 61010-2-032
CAT III 600V
Pollution Degree 2

Overvoltage Category I (CAT I):

Equipment for connection to circuits in which measures are taken to limit the transient overvoltages to an appropriate low level.

Overvoltage Category II (CAT II):

Energy-consuming equipment to be supplied from the fixed installation.

Overvoltage Category III (CAT III):

Equipment in fixed installations.

SAFETY INFORMATION: (Read First Before Operation)

Please follow the following instructions carefully for safe operation.

- NEVER use the clamp meter for Voltages higher than 600V.
- DO NOT hold the clamp meter beyond its tactile barrier.
- DO NOT use the clamp meter and accessories if they look damaged.
- USE CAUTION when working with high voltages.
- USE CAUTION when measuring the voltages higher than 30VAC rms or 60VDC. These voltages pose a shock hazard.
- USE EXTREME CAUTION when working around bare conductors or bus bars.
- ALWAYS use the clamp meter as the instructions in the manual.

<p>WARNING: If the flexible tester is used in a manner Not specified by the manufacturer, the protection Provided by the clamp meter may be impaired.</p>
--

TABLE OF CONTENTS

I. FEATURES	1
II. PANEL DESCRIPTION	2
III. OPERATING INSTRUCTIONS	4
III.1 Setup.....	4
III.2 Measurement of RMS value, THD-F and Harmonics of ACV	13
III.3 Measurement of RMS value, THD-F and Harmonics of ACA	16
III.4 Waveforms of ACV and ACA with Phase Angle (φ).....	19
III.4.1 Waveform of ACV with Peak Value	20
III.4.2 Waveform of ACA with Peak Value	21
III.5 Measurement of Single Phase AC Power Quality.....	22
III.5.1 True Power (W) and Power Factor (PF)	23
III.5.2 Apparent Power (VA, KVA) and Reactive Power (VAR, KVAR)	23
III.5.3 Maximum Demand (KW and KVA).....	24
III.5.4. Energy (KWh, PFh, KVARh, and KVAh).....	24
III.5.5 Phasor Diagram	24
III.5.6 RMS values of Voltage and Current.....	25
III.6 Measurement of Balanced 3 Phase AC Power Quality	26
III.6.1 AC Watt (W) and Power Factor (PF).....	26
III.6.2 Apparent Power (VA, KVA) and Reactive Power (VAR, KVAR)	27
III.6.3 Maximum Demand (KW and KVA).....	27
III.6.4 Energy (KWh, PFh, KVARh, and KVAh).....	27
III.6.5. Phasor Diagram	28
III.6.6. RMS values of Voltage and Current.....	28
IV. DATALOGGING OF VOLTAGE (RMS VALUE) AND HARMONICS	29
IV.1 Scheduled Datalogging	29
IV.2 Immediate Datalogging.....	32
V. DATALOGGING OF CURRENT (RMS VALUE) AND HARMONICS	33
V.1 Scheduled Datalogging	33
V.2 Immediate Datalogging.....	35

VI. DATALOGGING OF VOLTAGE AND CURRENT WAVEFORMS	36
VI.1 Datalogging of both Voltage and Current Waveforms	36
VI.2 Datalogging of Voltage Waveform	37
VI.3 Datalogging of Current Waveform	38
VII. DATALOGGING OF TRANSIENT DETECTION	39
VIII. DATALOGGING OF AC POWER	44
VIII.1 Scheduled Datalogging	44
VIII.2 Immediate Datalogging	46
IX. CLEAR DATA MEMORY	47
X. RS-232 INTERFACE PROTOCOL.....	47
XI. SPECIFICATIONS (23°C±5°C).....	48
XII. BATTERY REPLACEMENT	52
XIII. MAINTENANCE & CLEANING.....	54

I. FEATURES

- a. Power Quality Analysis for Single and Balanced Three Phase System.
- b. Harmonic Analysis of Voltage and Current (1 to 50th order).
- c. True RMS measurement of V with 0.5% of reading basic accuracy.
- d. True RMS measurement of A with 1% of reading basic accuracy
- e. Graphic Waveform of Voltage and Current
- f. Graphic Phasor Diagram
- g. Transient Detection and Logging of Swell, Dip, and Outage.
- h. Fast peak function (39 μ s for 50 Hz, 33 μ s for 60Hz).
- i. Active (W, KW, HP), reactive (VAR, KVAR) and apparent (VA, KVA) power
- j. Power factor (PF), phase angle (Φ), and energy (WH, KWH, KVARH, PFH).
- k. Measurement of balanced 3 Φ Power Quality.
- l. Programmable VT ratio from 1 to 3000.
- m. Hold functions.
- n. Auto power off function in 15 minutes (selectable).
- o. Datalogging and Download to a PC.
- p. Optical isolated USB data connection.
- q. Unlimited datalogging facility on a PC.

II. PANEL DESCRIPTION

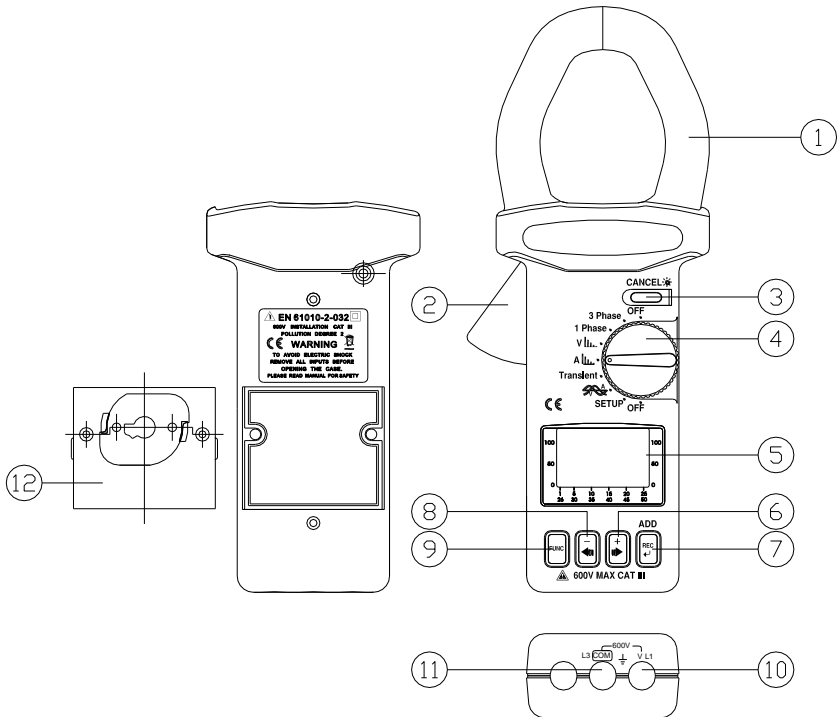

1. Jaw Assembly

2. Trigger

Press the trigger to open the jaw assembly.

3. HOLD/CANCEL/BACK LIGHT

Press this button to HOLD the display in LCD, or turn the backlight on or off. It is also used to delete harmonics in the harmonics configuration

4. Rotary Switch

Select setup, measurement of current, voltage, transient detection, or power.
Turn the unit on or off.

5. LCD

This is a dot matrix LCD with backlight.

6. + ► Button

- . Increment value by 1
- . Move the reference axis up
- . Move the line cursor right to previous harmonics
- . Page up to next transient events

7. REC

Press this button to start Datalogging. Press again to stop. Holding the button and turning the power on will clear the data memory.

It is also used to add harmonics in the harmonics configuration.

8. - ◀ Button

- . Decrement value by 1
- . Move the reference axis down
- . Move the line cursor left to next harmonics
- . Page down to next transient events

9. FUNC Button

Press this button to select different display.

10. V Input Terminal

This terminal is used as input for voltage.

11. COM Terminal

This terminal is used as common voltage reference input.

12. RS-232 window and Battery Cover

III. OPERATING INSTRUCTIONS

III.1 Setup

Move the rotary switch to the SETUP position. Users should setup the parameters of the meter before use.

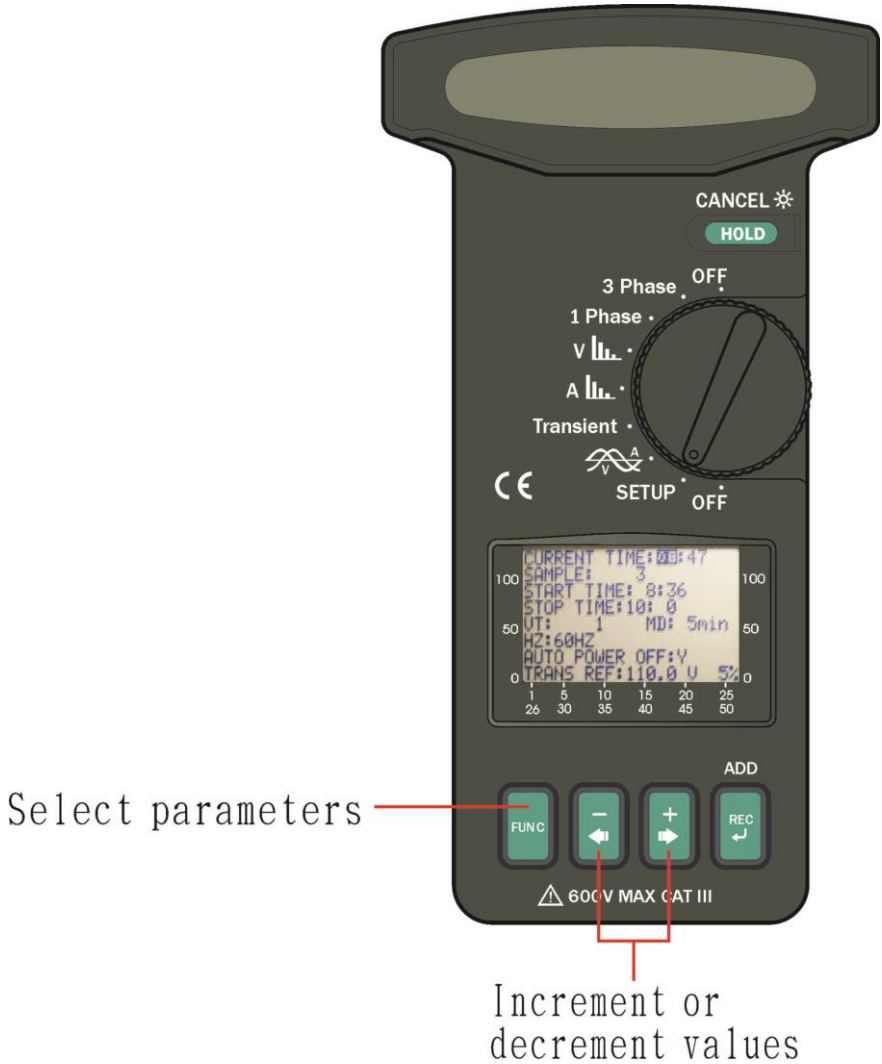

CURRENT TIME: There is a calendar clock inside the meter. Users should setup the correct time.

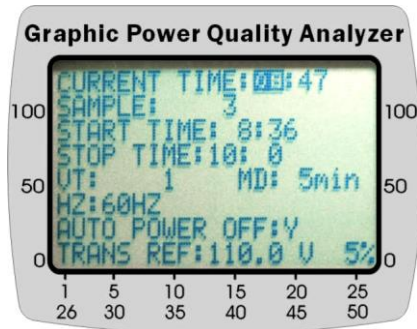

HOUR

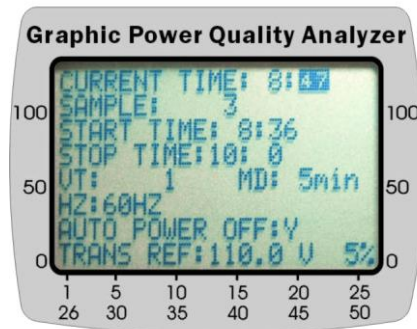

MINUTE

SAMPLE: Setup the sampling interval in seconds for Datalogging.

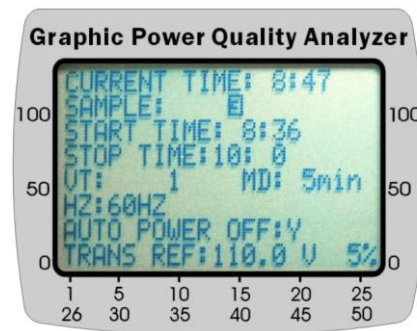

START TIME: schedule when to start datalogging

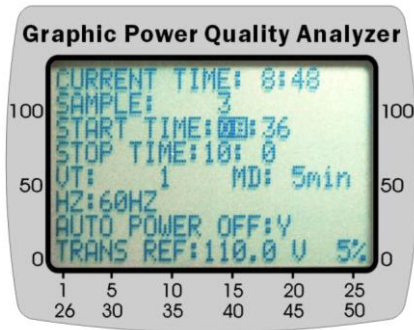

HOUR

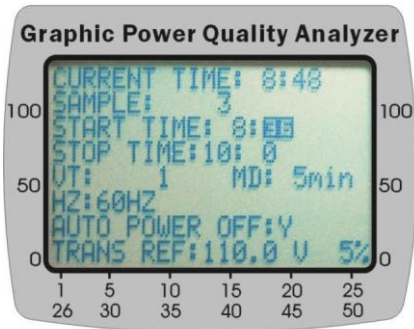

MINUTE

STOP TIME: schedule when to stop datalogging

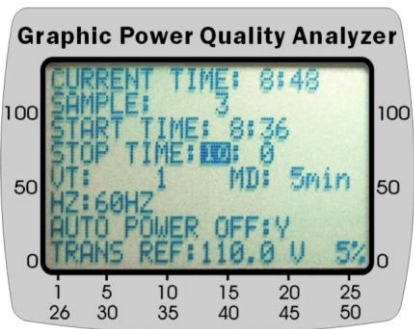

HOUR

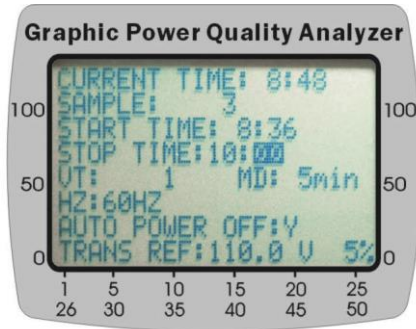

MINUTE

VT: set the ratio of voltage transformer, normally 1.

$$\underline{V \text{ (reading)}} = \text{Voltage} * VT$$

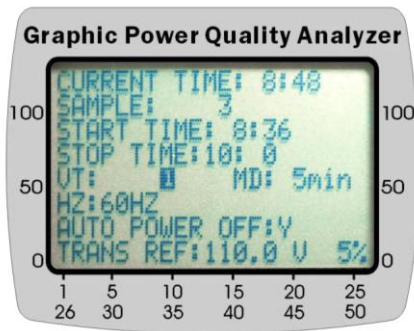

MD: set the time interval form maximum demand in minutes (1 to 60 minutes), normally 15.

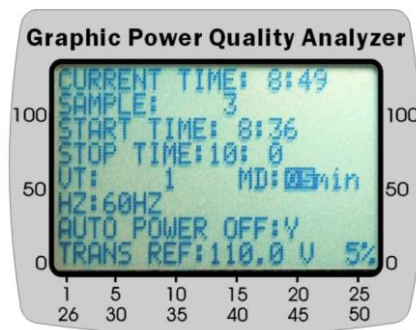

HZ: set the operating frequency to 50Hz, 60Hz, or Auto.

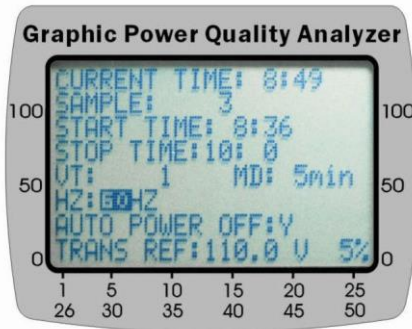

AUTO POWER OFF: enable (1) or disable (0) auto-power-off function.

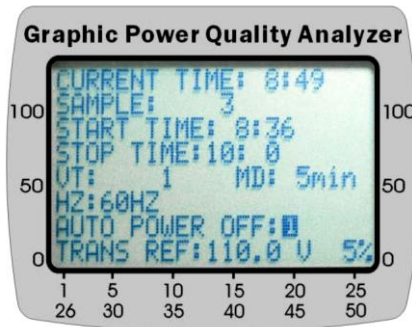

TRANSIENT REFERENCE: set the nominal voltage and threshold (%) for transient capture.

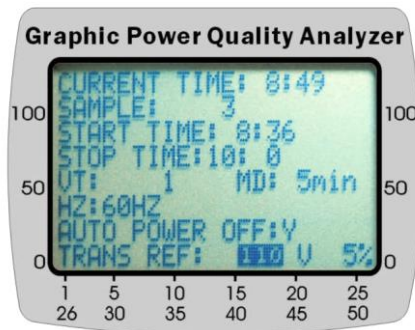

NOMINAL VOLTAGE

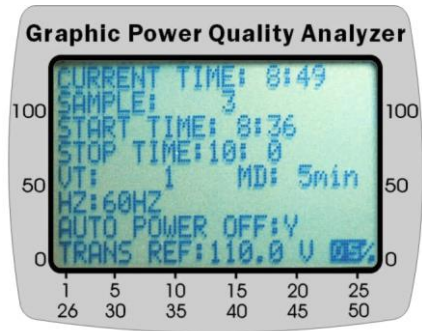

TOLERANCE

HARMONICS CONFIGURATION: select the harmonics to be logged.

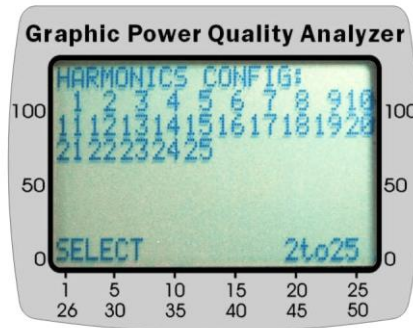

NOTE: The unit will adjust the sampling time according to the amount of harmonics to be logged

WAVEFORM CONFIGURATION: set the points to be logged for each cycle of the waveform. There are four options, 32, 64, 128, and 256.

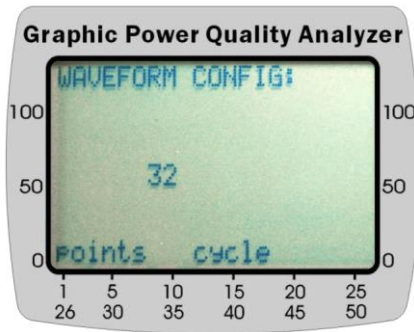

NOTE: The unit will adjust the sampling time according to the processing time required to log waveform.

DATE: set the date of the internal calendar clock.

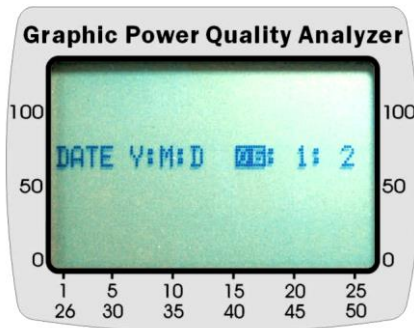

YEAR

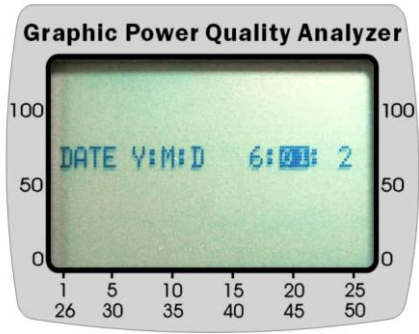

MONTH

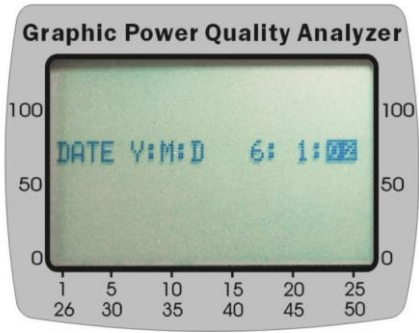

DAY

III.2 Measurement of RMS value, THD-F and Harmonics of ACV

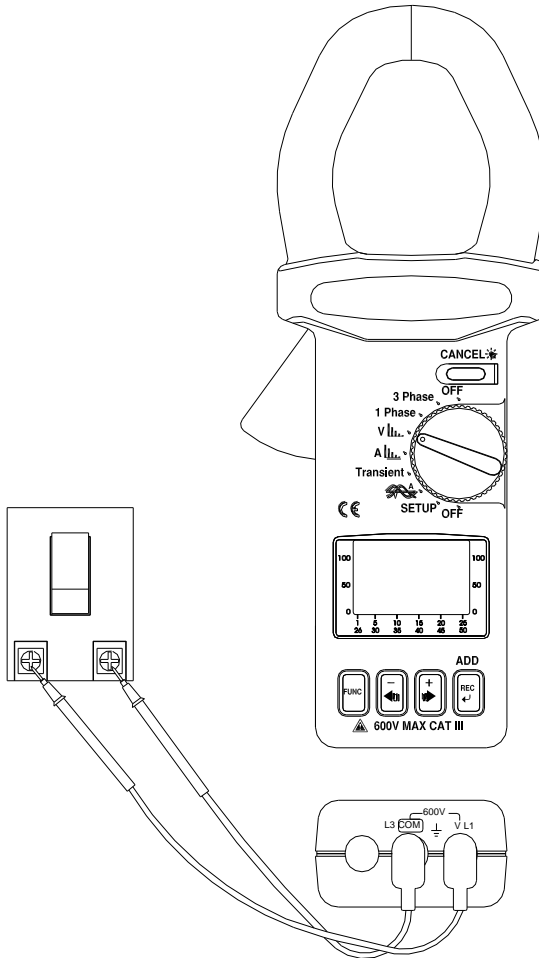

Voltage:

- Set the rotary switch at V position.
- Insert the test leads into the input jack. Connect the test prods of the test leads in PARALLEL to the circuit to be measured.

NOTE: If the peak value of the input AC voltage is greater than the maximum value of the range, then symbol of OL will be displayed.

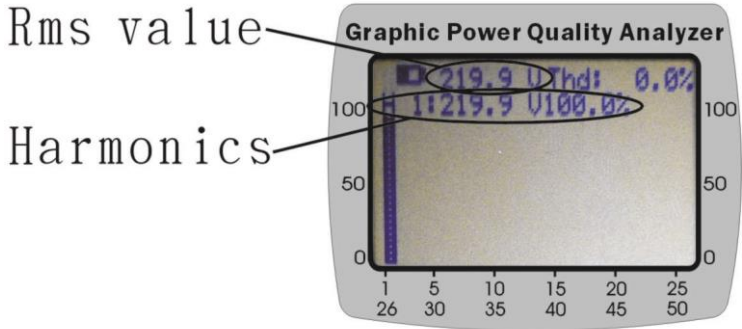

%THD-F: Total Harmonic Distortion with respect to Fundamental frequency

$$\%THD-F = (\sqrt{V_2^2 + V_3^2 + \dots + V_{49}^2 + V_{50}^2}) / V_1 * 100$$

Where,

V1: magnitude at the nominal frequency (eg.50 or 60 Hz)

V2: magnitude at the second harmonics

...

V50: magnitude at the 50-th harmonics.

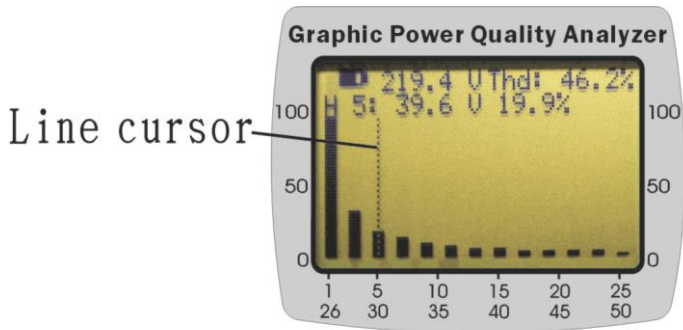



Move line cursor

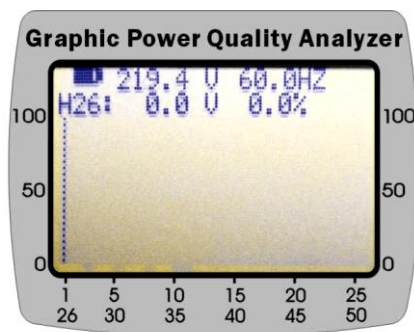

NOTE: Frequency (Hz) is displayed in the second page (Harmonics order 25th to 50th order).

III.3 Measurement of RMS value, THD-F and Harmonics of ACA

- a. Set the rotary switch at A position.
- b. Clamp on to the conductor, and read the data from LCD display.

WARNING: Make sure that all the test leads are disconnected from the meter's terminals for current measurement.

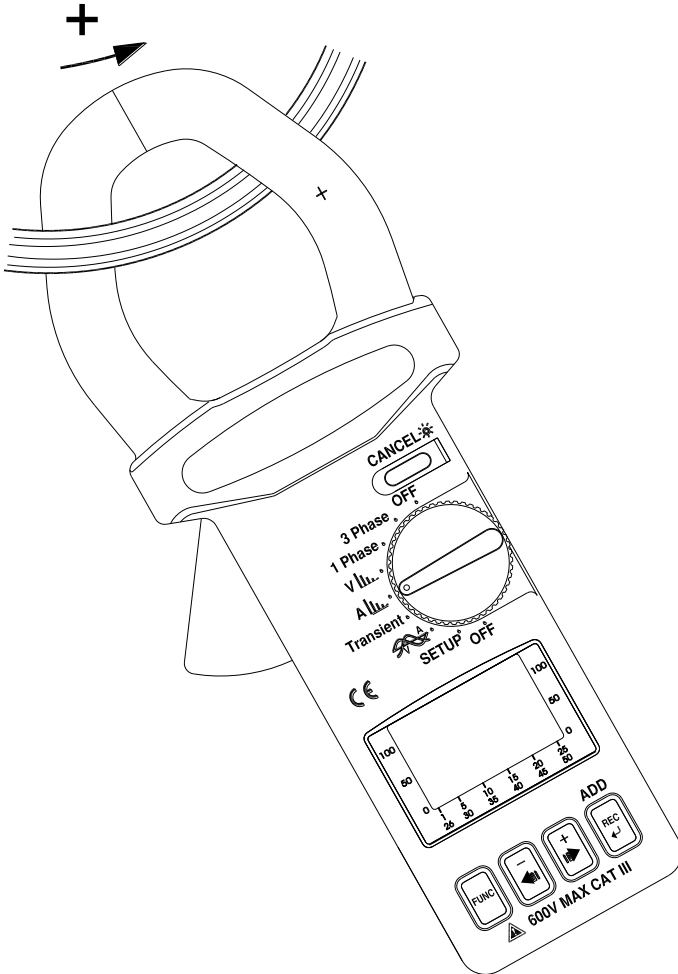

Rms value

Harmonics

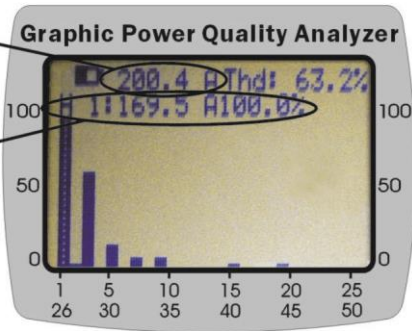

%THD-F: Total Harmonic Distortion with respect to Fundamental frequency

$$\%THD-F = (\sqrt{V2^2 + V3^2 + \dots + V49^2 + V50^2}) / V1 * 100$$

Where,

V1: magnitude at the nominal frequency (eg.50 or 60 Hz)

V2: magnitude at the second harmonics

...

V50: magnitude at the 50-th harmonics.

Line cursor

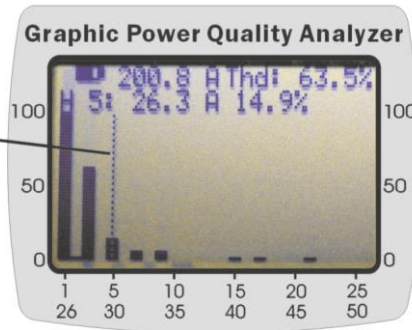



Move line cursor

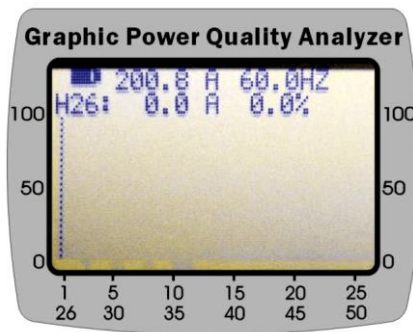

NOTE: Frequency (Hz) is displayed in the second page (Harmonics order 25th to 50th order).

III.4 Waveforms of ACV and ACA with Phase Angle (ϕ)

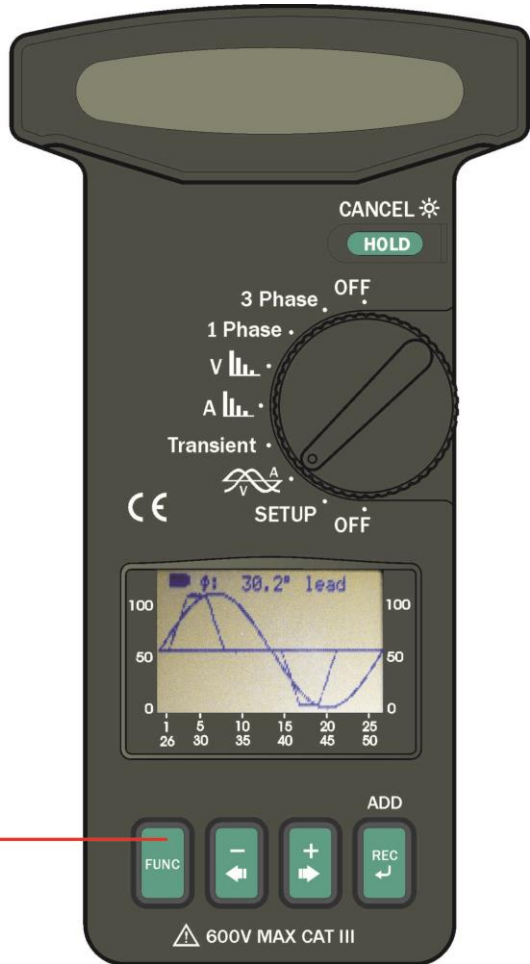

When users set the rotary switch at waveform position, the unit will display both voltage and current waveform with phase angle.

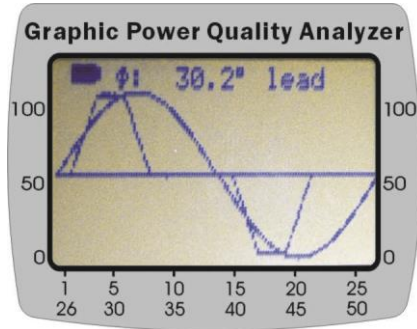

Users can press the +▶ or -◀ buttons to move the 0 reference axis of current up or down. So the waveforms of voltage and current can be easily distinguished as in the following figure.

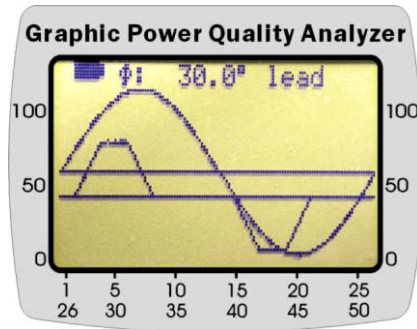

III.4.1 Waveform of ACV with Peak Value

Press the FUNC button to select display of voltage waveform with RMS value and peak value

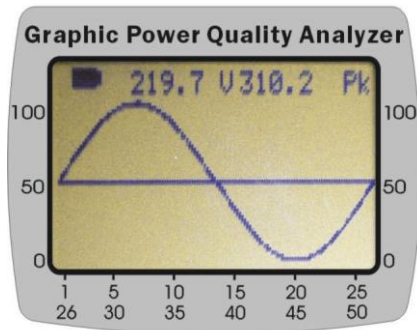

III.4.2 Waveform of ACA with Peak Value

Press the FUNC button to select display of current waveform with RMS value and peak value

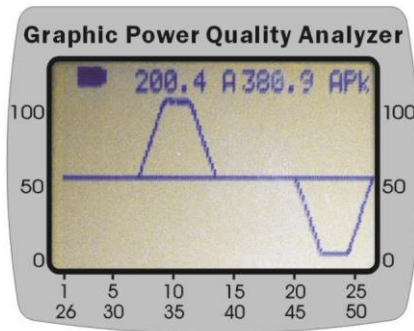

III.5 Measurement of Single Phase AC Power Quality

NOTE: If the peak value of the input AC current or AC voltage is greater than the maximum value of the range, then symbol of OL will be displayed.

NOTE: If the VT ratio is not 1, the readings of shown in LCD is equal to the W, VA, and VAR values measured by the tester multiplied by VT ratio ($W_{LCD} = W \times VT$, $VA_{LCD} = VA \times VT$, $VAR_{LCD} = VAR \times VT$, $WH_{LCD} = WH \times VT$).

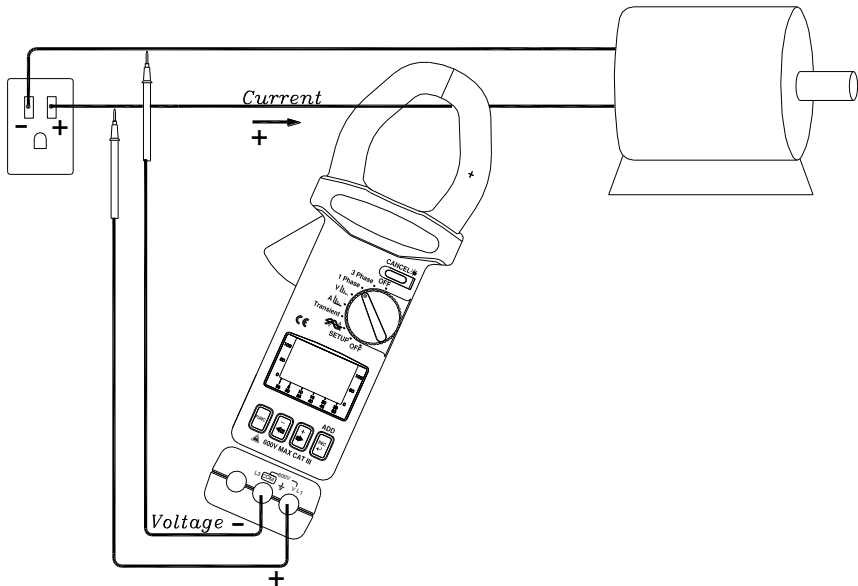

- Set the rotary switch at the 1 Phase position
- Connect the test leads to the voltage source in parallel with the load.
- Clamp on one of the wire to the load. The current should flow from the front of the tester to the side of the battery cover
- Press FUNC to select following display.

III.5.1 True Power (W) and Power Factor (PF)

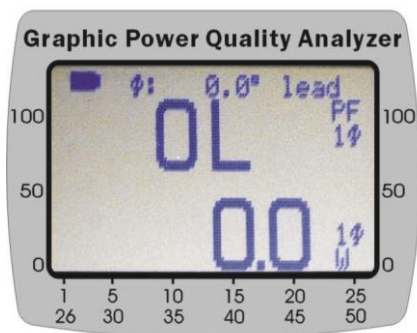
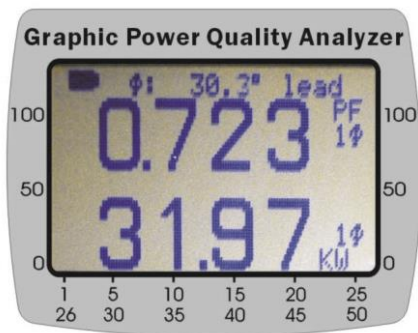

III.5.2 Apparent Power (VA, KVA) and Reactive Power (VAR, KVAR)

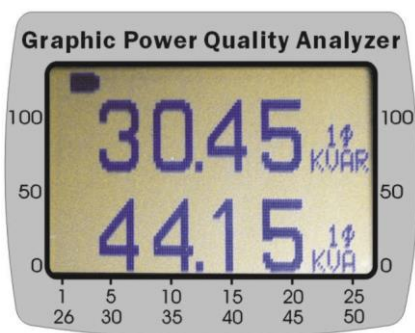

III.5.3 Maximum Demand (KW and KVA)

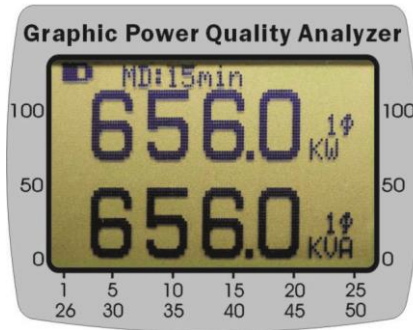

WARNING: Must disable auto-power-off for this measurement.

III.5.4. Energy (KWh, PFh, KVARh, and KVAh)

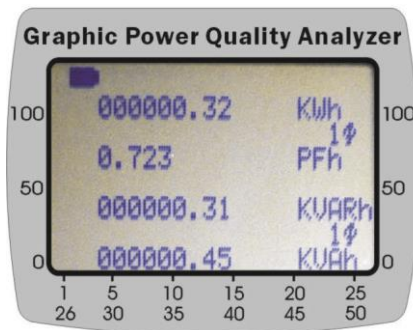

WARNING: Must disable auto-power-off for this measurement.

III.5.5 Phasor Diagram

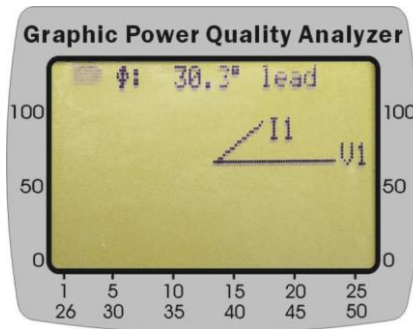

III.5.6 RMS values of Voltage and Current

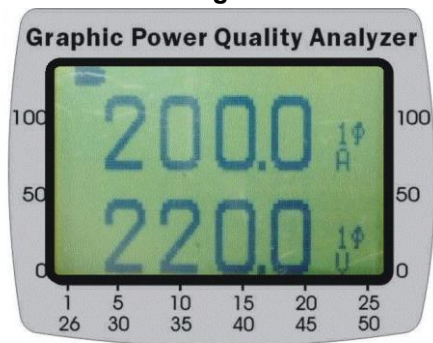

III.6 Measurement of Balanced 3 Phase AC Power Quality

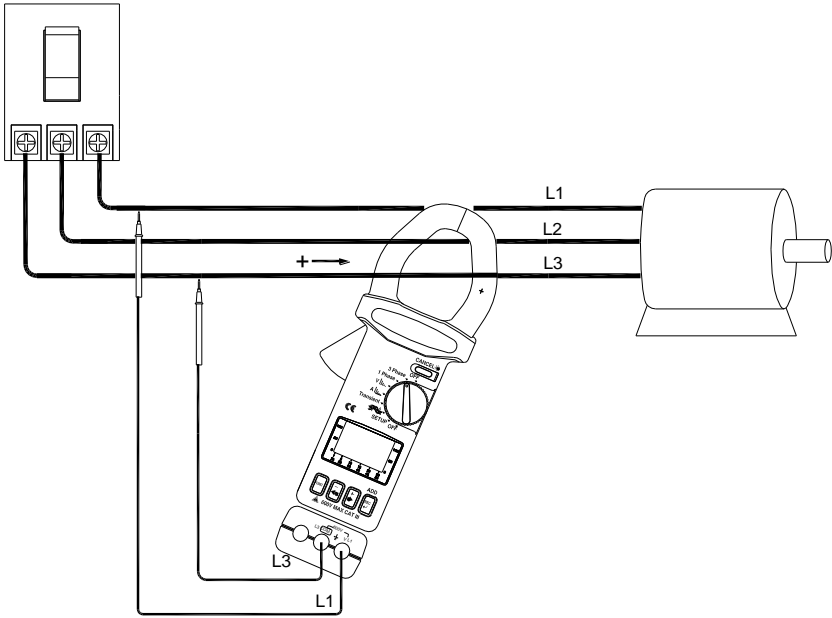

- Set the rotary switch at the 3 Phase position
- Connect the test leads to the voltage source in parallel with the load.
- Clamp on one of the wire to the load. The current should flow from the front of the tester to the side of the battery cover
- Press 3ϕ button for balanced 3ϕ system measurement.
- Press the FUNC button to select following displays

III.6.1 AC Watt (W) and Power Factor (PF)

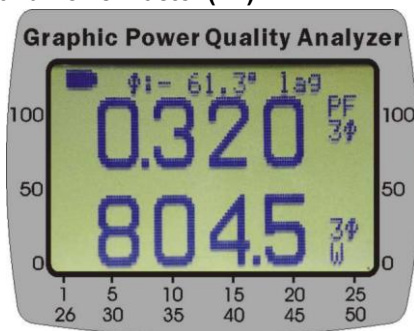

III.6.2 Apparent Power (VA, KVA) and Reactive Power (VAR, KVAR)

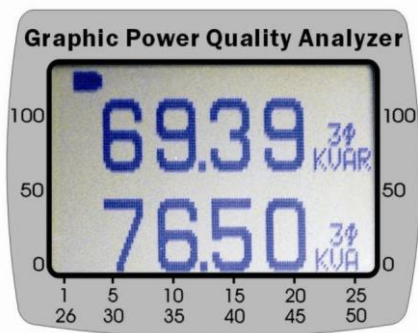

III.6.3 Maximum Demand (KW and KVA)

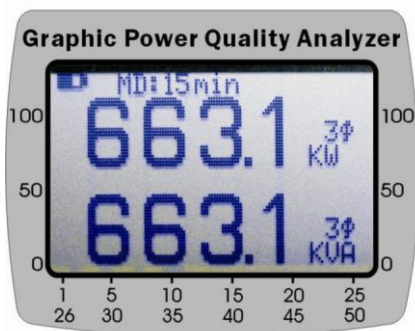

WARNING: Must disable auto-power-off for this measurement.

III.6.4 Energy (KWh, PFh, KVARh, and KVAh)

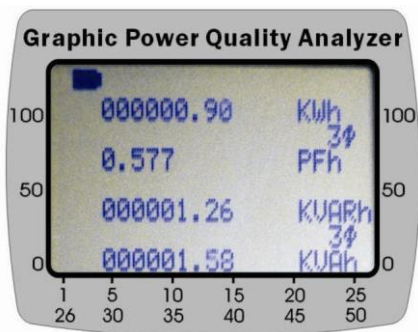

WARNING: Must disable auto-power-off for this measurement.

III.6.5. Phasor Diagram

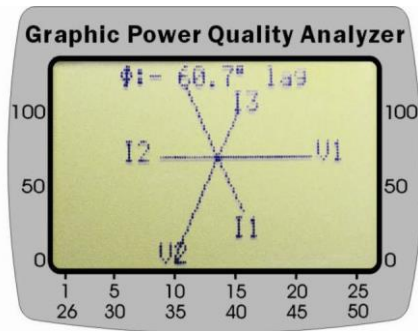

III.6.6. RMS values of Voltage and Current

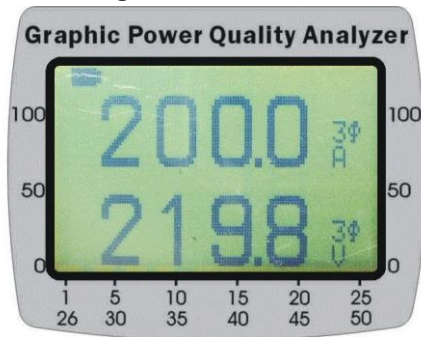

IV. DATALOGGING OF VOLTAGE (RMS VALUE) AND HARMONICS

IV.1 Scheduled Datalogging

Set the rotary switch at the V position and **press the REC button ONCE.**

If users see the following display and press the REC button, the true RMS value of voltage and selected harmonics set in the configuration will be logged at specified sampling interval.

The **START TIME** and **STOP TIME** is set in the SETUP.

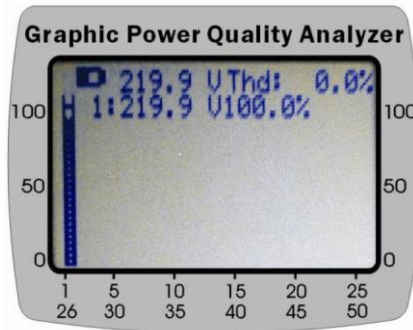

NOTE: The true RMS value and the first harmonics are always logged.



When the REC button is pressed, users will see the following display.

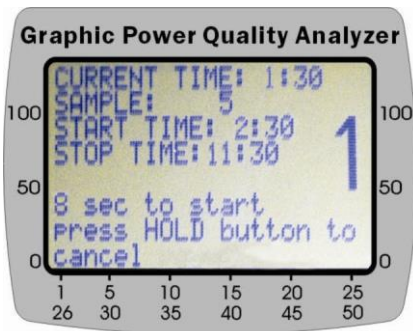
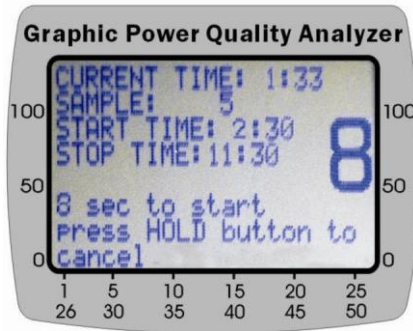

Users always have 8 seconds to cancel Datalogging by pressing the HOLD button for **about 2 seconds**. If users do not press HOLD/CANCEL button, the unit starts Datalogging, and the LED next to the REC button starts blinking.



IV.2 Immediate Datalogging

Press the REC button **TWICE**

START TIME will be changed to next minute.

STOP TIME will be changed to current time tomorrow.

Please refer to HARMONICS CONFIGURATION of SETUP for selecting harmonics.

V. DATALOGGING OF CURRENT (RMS VALUE) AND HARMONICS

V.1 Scheduled Datalogging

Set the rotary switch at the A position and **press the REC button ONCE.**

The true RMS value of current and selected harmonics set in the configuration will be logged at specified sampling interval. The **START TIME** and **STOP TIME** is set in the SETUP.



When the REC button is pressed, users will see the following display.

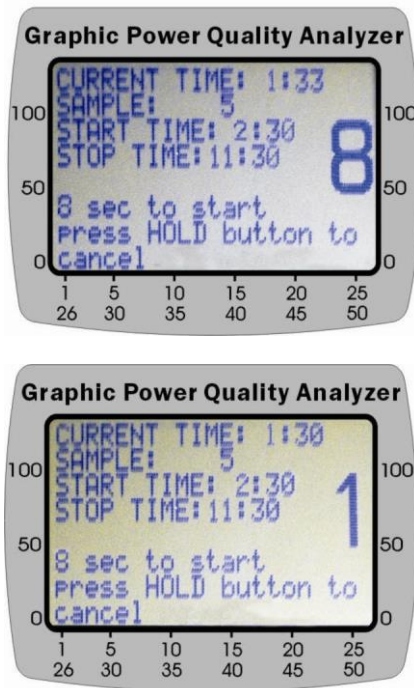

Users always have 8 seconds to cancel datalogging by pressing the HOLD button for **about 2 seconds**. If users do not press HOLD/CANCEL button, the unit starts datalogging, and **the LED at the bottom starts blinking**.

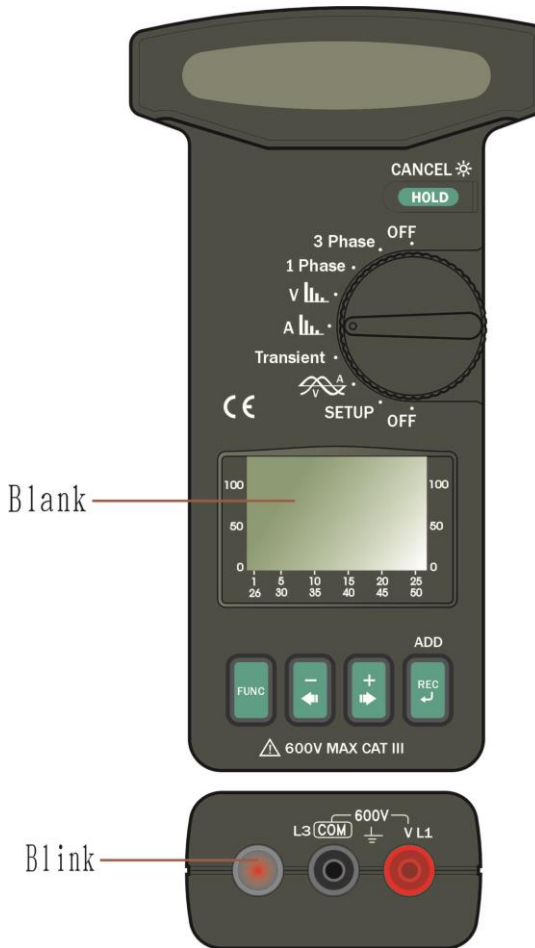

Please refer to HARMONICS CONFIGURATION of SETUP for selecting harmonics.

NOTE: The true RMS value and the first harmonics are always logged.

V.2 Immediate Datalogging

Press the REC button **TWICE**, the unit start Datalogging in the next minute.

START TIME will be changed to next minute.

STOP TIME will be changed to current time tomorrow.

VI. DATALOGGING OF VOLTAGE AND CURRENT WAVEFORMS

VI.1 Datalogging of both Voltage and Current Waveforms

Set the rotary switch at the VA waveform, and press the FUNC to select display of both voltage and current waveforms.

Press the REC button once to do scheduled Datalogging. Both voltage and current waveforms will be logged.



NOTE: Users can specify how many points per cycle in the WAVEFORM CONFIGURATION of SETUP.

VI.2 Datalogging of Voltage Waveform

Set the rotary switch at the VA waveform and press the FUNC to select display of voltage waveform.

Press the REC button once to do scheduled Datalogging. Voltage waveform will be logged.



NOTE: Users can specify how many points per cycle in the WAVEFORM CONFIGURATION of SETUP.

VI.3 Datalogging of Current Waveform

Set the rotary switch at the VA waveform and press the FUNC to select display of current waveform.

Press the REC button once to do scheduled Datalogging. Current waveform will be logged.



NOTE: Users can specify how many points per cycle to be logged in the WAVEFORM CONFIGURATION of SETUP.

VII. DATALOGGING OF TRANSIENT DETECTION

Set the rotary switch to the **Transient** position, the following display is shown.

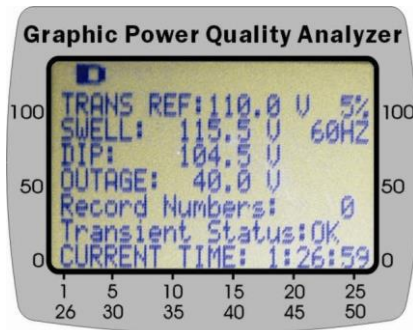

It shows the reference voltage is AC 110.0V (**TRANS REF**), and the threshold is 5%. If the voltage exceeds 115.5V (**SWELL**) or is less than 104.5V (**DIP**), or is less than the 40.0V (**OUTAGE**), one transient event will be logged.

NOTE: Maximum 32000 events

Press the FUNC button to start transient detection.



After users press the FUNC button, the LCD will become blank and the LED at the bottom starts to flash.

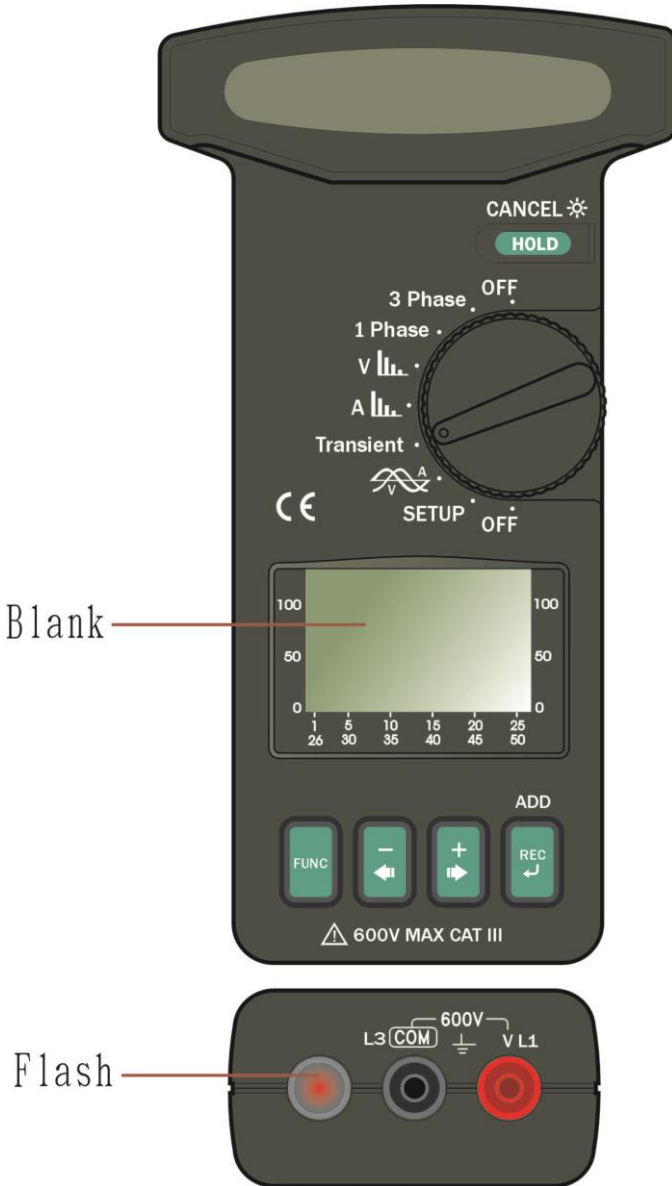

To stop transient detection and review events, press the FUNC button again. Press the +▶ or -◀ buttons to review events.



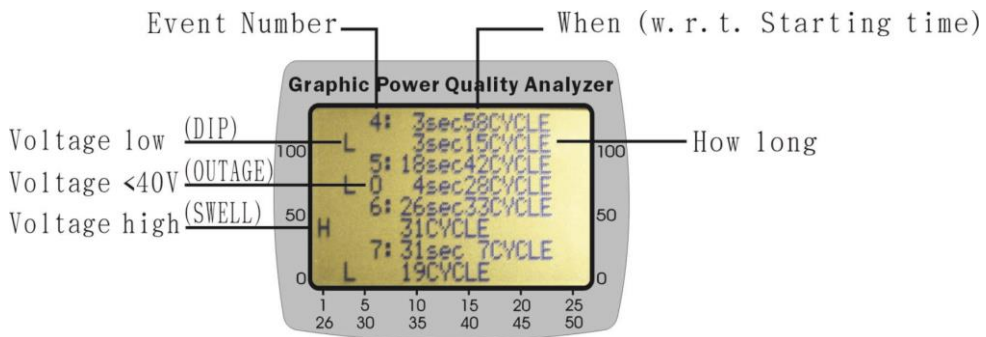
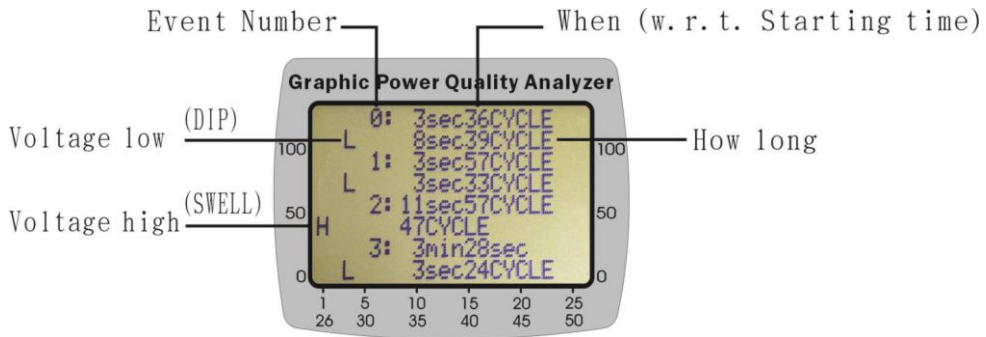

VIII. DATALOGGING OF AC POWER

VIII.1 Scheduled Datalogging

Press the REC button **ONCE**



Users can press the REC button once to start scheduled datalogging. The **START TIME** and **STOP TIME** is set in the SETUP.

When the REC button is pressed, users will see the following display.

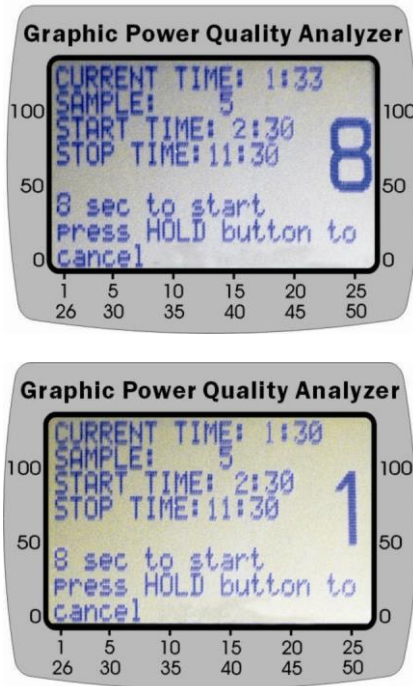

Users always have 8 seconds to cancel Datalogging by pressing the HOLD button for **about 2 seconds**. If users do not press HOLD/CANCEL button, the unit starts Datalogging, and the LED next to the REC button starts blinking.



The unit will log 50,000 records of (Date/Time, VA, W, VAR, PF, KVAH, KWH, KVARH, PFH, AD(VA), AD(W), MD(VA), MD(W), Phase, HP).

VIII.2 Immediate Datalogging

Press the REC button **TWICE**

START TIME will be changed to next minute.

STOP TIME will be changed to current time tomorrow.

IX. CLEAR DATA MEMORY

To clear the memory of data logger, hold the REC button and turn the power on. The following display will be shown in LCD. Users press the HOLD button to confirm the clearance of memory. The unit is turned off after the memory is cleared.

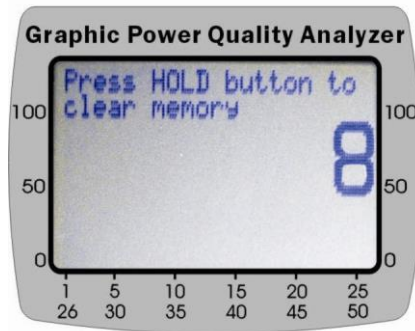

If users do not press the HOLD button in 8 seconds, the memory is not clear. This timer could avoid users accidentally clear the memory.

X. RS-232 INTERFACE PROTOCOL

Baud Rate:	9600
Data Bits:	8
Stop Bit:	1
Parity:	None
Format:	ASCII

XI. SPECIFICATIONS (23°C±5°C)

AC Watt (50 or 60 Hz, PF 0.5 to 1.0, VT = 1, Voltage > 5V AC, Current > 5A AC for A range, and continuous waveform)

Range (0 to 1500A)	Resolution	Accuracy of Readings ¹	
		> 20 V and > 20A	< 20V or < 20A
10.0 – 999.9 W	0.1W	±1% ±20dgts	±2% ±40dgts
1.000 – 9.999 KW	0.001 KW	±1% ±20dgts	±2% ±40dgts
10.00 – 99.99 KW	0.01 KW	±1% ±20dgts	±2% ±40dgts
100.0 – 999.9 KW	0.1 KW	±1% ±20dgts	±2% ±40dgts
1000 – 9999 KW	1 KW	±1% ±20dgts	±2% ±40dgts

¹For VT ≠1, the accuracy in percentage is the same (±1%). But the additional wattage should be multiplied by the VT ratio.

For example, ±0.2W becomes ±0.2W * VT ratio

AC Apparent Power (VA, from 0.000VA to 9999 KVA, PF 0.5 to 1)

Range (0 to 1500A)	Resolution	Accuracy of Readings ¹	
		> 20 V and > 20A	< 20V or < 20A
10.0 – 999.9 VA	0.1VA	±1% ±20dgts	±2% ±40dgts
1.000 – 9.999 KVA	0.001 KVA	±1% ±20dgts	±2% ±40dgts
10.00 – 99.99 KVA	0.01 KVA	±1% ±20dgts	±2% ±40dgts
100.0 – 999.9 KVA	0.1 KVA	±1% ±20dgts	±2% ±40dgts
1000 – 9999 KVA	1 KVA	±1% ±20dgts	±2% ±40dgts

¹For VT ≠1, the accuracy in percentage is the same (±1%). But the additional wattage should be multiplied by the VT ratio.

For example, ±0.2VA becomes ±0.2VA * VT ratio

AC Reactive Power (VAR, from 0.000 VAR to 9999 KVAR)

Range (0 to 1500A)	Resolution	Accuracy of Readings ¹	
		> 20 V and > 20A	< 20V or < 20A
10.0 – 999.9 VAR	0.1VAR	±2% ±30dgts	±3% ±40dgts
1.000 – 9.999 KVAR	0.001 KVAR	±2% ±30dgts	±3% ±40dgts
10.00 – 99.99 KVAR	0.01 KVAR	±2% ±30dgts	±3% ±40dgts
100.0 – 999.9 KVAR	0.1 KVAR	±2% ±30dgts	±3% ±40dgts
1000 – 9999 KVAR	1 KVAR	±2% ±30dgts	±3% ±40dgts

¹For VT ≠1, the accuracy in percentage is the same (±2%). But the additional wattage should be multiplied by the VT ratio.

For example, ±0.2VAR becomes ±0.2VAR * VT ratio

Range of VT (Voltage Transformer) Ratio: 1 to 3000

AC Active Energy (WH, or KWH, from 0 WH to 999,999 KWH)

$$WH = W * \text{Time (in hours)}$$

AC Current (50 or 60 Hz, Auto Range, True RMS, Crest Factor < 4, Overload Protection AC 2000A)

Range	Resolution	Accuracy of Readings
4.0 – 1500.0 A	0.01 A	±1.0% ± 5dgts

AC Voltage (50 or 60 Hz, Auto Range, True RMS, Crest Factor < 4, VT=1, Input Impedance 10 MΩ, Overload Protection AC 800V)

Range	Resolution	Accuracy of Readings ¹
4.0 V – 600.0 V	0.1 V	±0.5% ± 5dgts

¹For VT ≠ 1, the accuracy in percentage is the same (±0.5%). But the additional digits should be multiplied by the VT ratio.

For example, ±5digits becomes ± 5digits * VT ratio

Harmonics of AC Voltage in Percentage (1 to 50th order, minimum voltage at 50 or 60 Hz > AC 80V. If the voltage is 0 at 50 or 60 Hz, all the percentage (%) display is 0.)

Range	Resolution	Accuracy
1 – 20 th	0.1%	±2%
21 – 50 th	0.1%	4% of reading ±2.0%

Harmonics of AC Voltage in Magnitude (1 to 50th order, minimum voltage at 50 or 60 Hz > AC 80V, VT=1)

Range	Resolution	Accuracy
1 – 20 th	0.1%	±2% ± 0.5V
21 – 50 th	0.1%	4% of reading ±0.5V

Harmonics of AC Current in Percentage (1 to 50th order, minimum current at 50 or 60 Hz > 20 A. If the current is 0 at 50 or 60 Hz, all the percentage (%) display is 0.)

Range	Resolution	Accuracy
1 – 20 th	0.1%	±2%
21 – 50 th	0.1%	4% of reading ±2.0%

Harmonics of AC Current in Magnitude (1 to 50th order, minimum current at 50 or 60 Hz > 20A)

Range	Resolution	Accuracy
1 – 20 th	0.1%	±2% of reading ±0.4A
21 – 50 th	0.1%	±4% of reading ±0.4A

Power Factor (PF)

Range	Resolution	Accuracy	
		> 20V and > 20A	< 20V or < 20A
0.000 – 1.000	0.001	± 0.04	±0.1

Phase Angle (Φ)

Range	Resolution	Accuracy
-180° to 180°	0.1°	± 1°
0° to 360°	0.1°	± 1°

Total Harmonic Distortion (THD-F with respect to the 50 or 60 Hz, min. value at 50 or 60 Hz > 80V and > 20 A, 1 to 50th Harmonics. If the voltage or current is 0 at 50 or 60 Hz, all the percentage (%) display is 0)

Range	Resolution	Accuracy
0.0 – 20%	0.1%	± 2%
20.1 – 100%	0.1%	± 6% of reading ± 1%
100.1 – 999.9 %	0.1%	± 10% of reading ± 1%

Peak Value of AC Voltage (peak value > 10V) or AC Current (peak value > 20A)

Range	Sampling Time	Accuracy of Reading
50 Hz	39 μs	± 5% ± 50 digits
60 Hz	33 μs	± 5% ± 50 digits

Frequency (RMS value > 20V) or ACA (RMS value > 30A)

Range	Resolution	Accuracy
46 – 65	0.1	± 0.3Hz

Indoors Use

- Conductor Size: 55mm (approx.), 65 x 24mm (bus bar)
- Battery Type: two 1.5V SUM-3
- Display: 128 X 64 dot matrix LCD with backlight
- Range Selection: Auto
- Overload Indication: OL
- Power Consumption: 10 mA(approx.)
- Auto-Power-Off: 15 minutes after power-on
- Update Time: 2 times/second (display)
- No. Of Samples per Period 512 (voltage or current)
256 (power)
- Operating Temperature: -10°C to 50°C
- Operating Humidity: less than 85% relative
- Altitude: up to 2000M
- Storage Temperature: -20°C to 60°C
- Storage Humidity: less than 75% relative
- Dimension: 271mm (L) x 112mm (W) x 46mm (H)
10.7" (L) x 4.4" (W) x 1.8" (H)
- Weight: 647g / 22.8 oz (battery included)
- Accessories: Test leads
Carrying bag x 1
Users manual x 1
Software users manual x 1
Software CD x 1
Batteries 1.5V x 2
Alligator clips
RS232 to USB bridge x 1

XII. BATTERY REPLACEMENT

When the battery voltage low is shown in LCD,

- A. Turn the power off and remove the test leads from the box.
- B. Remove the screw of the battery compartment.
- C. Lift and remove the battery compartment.
- D. Remove the old batteries

E. Press the FUNC button for 2 seconds to discharge.

F. Insert two new 1.5V SUM-3 batteries.

G. Replace the battery compartment and secure the screw.

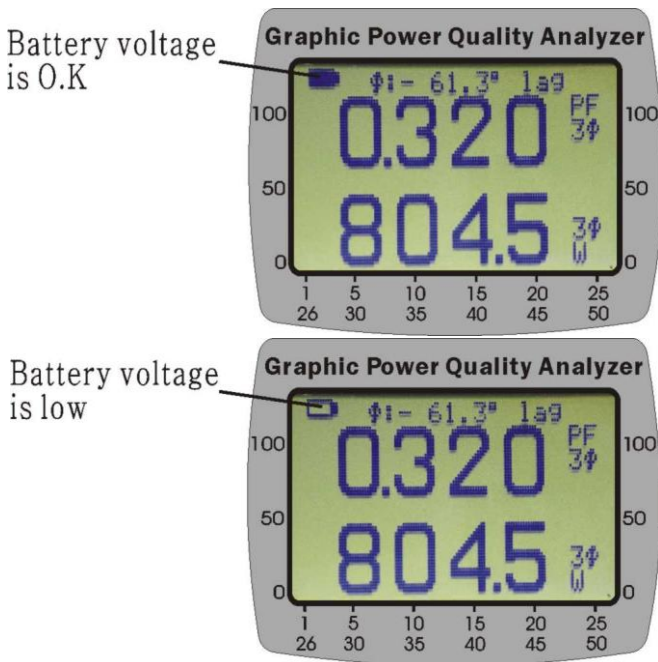

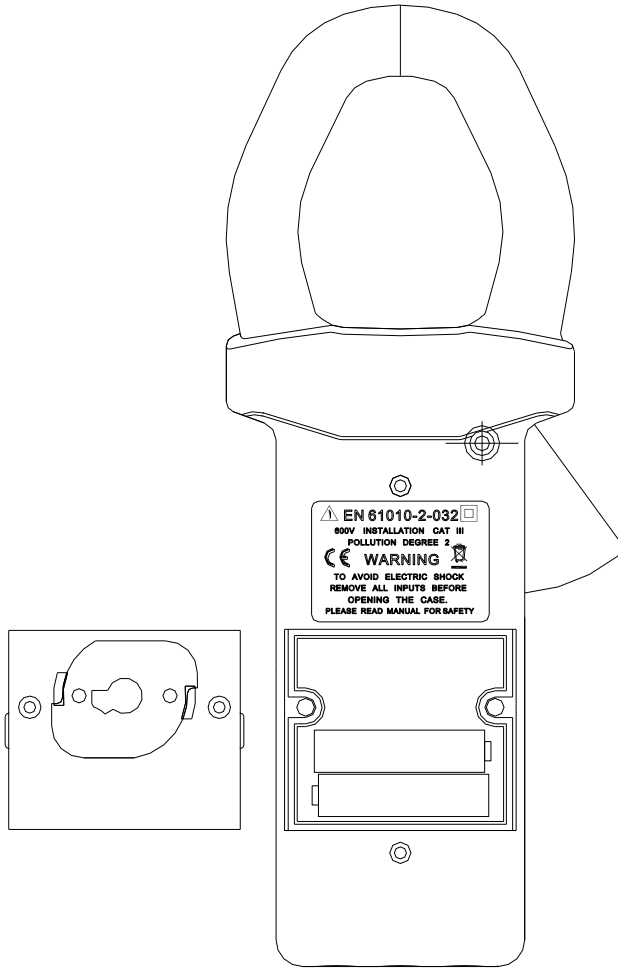

XIII. MAINTENANCE & CLEANING

Servicing not covered in this manual should only be performed by qualified personnel. Repairs should only be performed by qualified personnel. Periodically wipe the case with a damp cloth and detergent; do not use abrasives or solvents.

Address of Agent, Distributor, Importer, or Manufacturer

--