



EN 61010-2-032

CAT III 600V

Pollution Degree 2

Definition of Symbols:



Caution: Refer to Accompanying Documents



Caution: Risk of Electric Shock



Double Insulation

Over-voltage category III (CAT III):

equipment in fixed installations.

WARNING: If the power analyzer is used in a manner Not specified by the manufacturer, the protection Provided by the clamp meter may be impaired.



Please read the following instructions before usage

1. Do not operate in wet or dusty environments.
2. Do not operate in presence of combustible or explosive gas
3. Do not touch exposed metal parts, unused terminals.
4. Consider the use of rubber glove in operation.
5. Do not operate in excess of AC 500V (Phase to Neutral), or AC 600V (Phase to Phase)
6. Do not operate when the unit seems to be mal-functioning



Do not use the flexible current probe before you read the following instructions.

- 1. Do not install the flexible current probe around bare conductors carrying a voltage from 30V to 600V unless you are wearing protective clothing and glove suitable for high-voltage work.**
- 2. Always inspect and check for any damage of the current probe assembly before usage. Do not use the flexible current probe if any damage is found.**
- 3. Do not use the flexible current probe on circuit rated higher than 600V in installation category III.**

TABLE OF CONTENTS

I. FEATURES.....	1
II. PANEL DESCRIPTION	2
III. OPERATING INSTRUCTIONS	11
III.0. Set up before operation	13
III.1. Power Quality of a 3 Phase 4 Wire (3P4W) System.....	15
III.2 Power Quality of a 3 Phase 3 Wire (3P3W) System.....	17
III.3 Power Quality of a Single Phase (1P2W) System	19
III.4 Power Quality of a 1 Phase 3 Wire (1P3W) System.....	20
III.5 Measurement of a System with CT or VT.....	21
III.6 Harmonic Analysis of Voltage or Current.....	23
III.7 Display the Phase Angle of Harmonics.....	25
III.8 Measurement of Maximum Demand.....	26
III.9 Waveform of Voltage and Current.....	27
III.10 Waveform of Voltage Only	28
III.11 Graphic Phasor Diagram	29
III.12 Phase Sequence of a 3 Phase System.....	31
III.13 Balanced and Unbalanced 3 Phase (3P3W, 3P4W) Power Source System.....	32
III.14 Balanced and Unbalanced 3 Phase (3P3W or 3P4W) Load System.....	33
III.15 Transient Capture Setup (Dips, Swells, Outage).....	34
III.16 Download Transient Data	37
III.17 Data Logging of Power Data (3P4W, 3P3W, 1P2W, 1P3W).....	38
III.18 Download Power Data	39
III.19 Data Logging of Harmonics	40
III.20 Download Harmonics Data	41
III.21 Clear Memory of Data Logging.....	41
IV. HARDCOPY OF SCREEN	42
V. READ THE SAVED SCREEN	43
VI. SET THE CT AND VT RATIO.....	44
VII. SET THE TIME INTERVAL FOR MAXIMUM DEMAND.....	45
VIII. SET THE SAMPLING TIME FOR DATA LOGGING.....	46

IX. SET THE CALENDER CLOCK	47
X. PROTOCOL OF RS-232C INTERFACE	48
XI. SPECIFICATIONS (23°C± 5°C).....	49
XII. BATTERY REPLACEMENT	59
XIII. MAINTENANCE & CLEANING	61
XIV. NOMENCLATURE.....	62

I. FEATURES

- Analysis for 3P4W, 3P3W, 1P2W, 1P3W
- True RMS value (V_{123} and I_{123})
- Active Power (W, KW, MW, GW)
- Apparent and Reactive Power (KVA, KVAR)
- Power Factor (PF), Phase Angle (Φ)
- Energy (WH, KWH, KVARH, PFH)
- Current measurement from 0.1mA to 3000A, capable of analyzing IT standby power consumption to the maximum demand of a factory
- Display of 35 Parameters in One Screen (3P4W)
- Programmable CT (1 to 600) and PT (1 to 3000) Ratios
- Display of Overlapped Voltage and Current Waveform
- Average Demand (AD in W, KW, MW)
- Maximum Demand (MD in KW, MW, KVA, MVA) with Programmable Period
- Harmonic Analysis to the 99th Order
- Display of 50 Harmonics in one Screen with Waveform
- Display of Waveform with Peak Values (1024 Samples / Period)
- Analysis of Total Harmonic Distortion (THD-F)
- Graphic Phasor Diagram with 3 Phase System Parameters
- Capture 28 Transient Events (Time + Cycles) with Programmable Threshold (%)
- DIP, SWELL, and OUTAGE are included in transient events.
- 3 Phase Voltage or Current Unbalance Ratio (VUR, IUR)
- 3 Phase Voltage or Current Unbalance Factor (d0%, d2%)
- Calculated Unbalanced Current through Neutral Line (In)
- 512K Memory with Programmable Interval (Sampling time from 2 to 3000 seconds, 17,000 records for 3P4W system)
- Output of Waveform, Power Parameters and Harmonics at Command
- Large Dot Matrix LCD Display with Backlight
- Optical Isolated RS-232C to USB Interface
- Built-in timer and calendar for data logging

II. PANEL DESCRIPTION

PCE-830

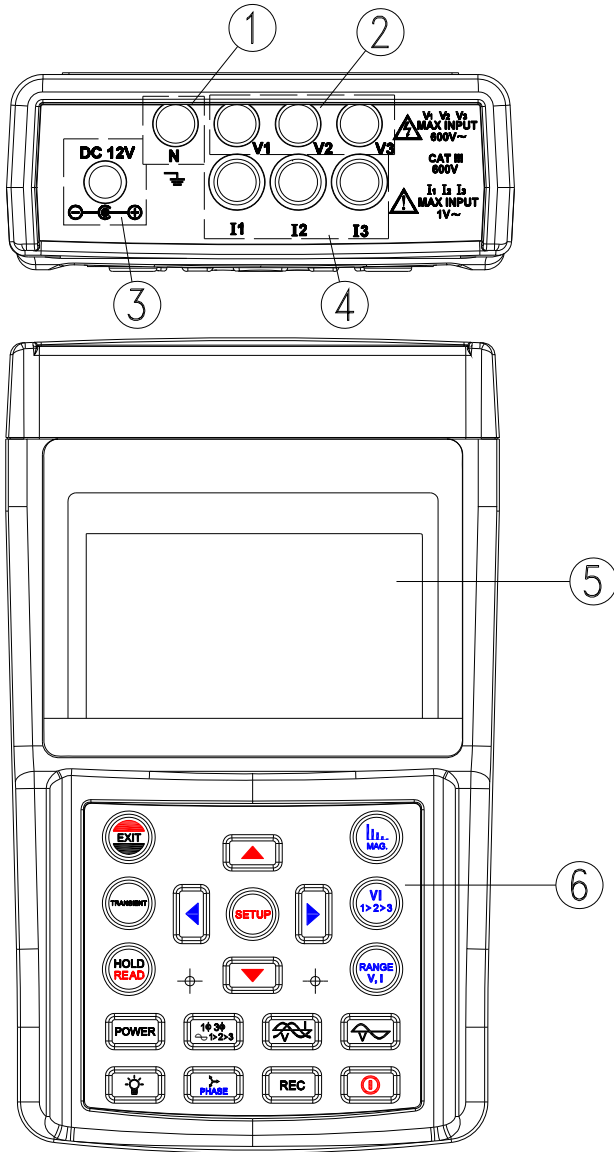

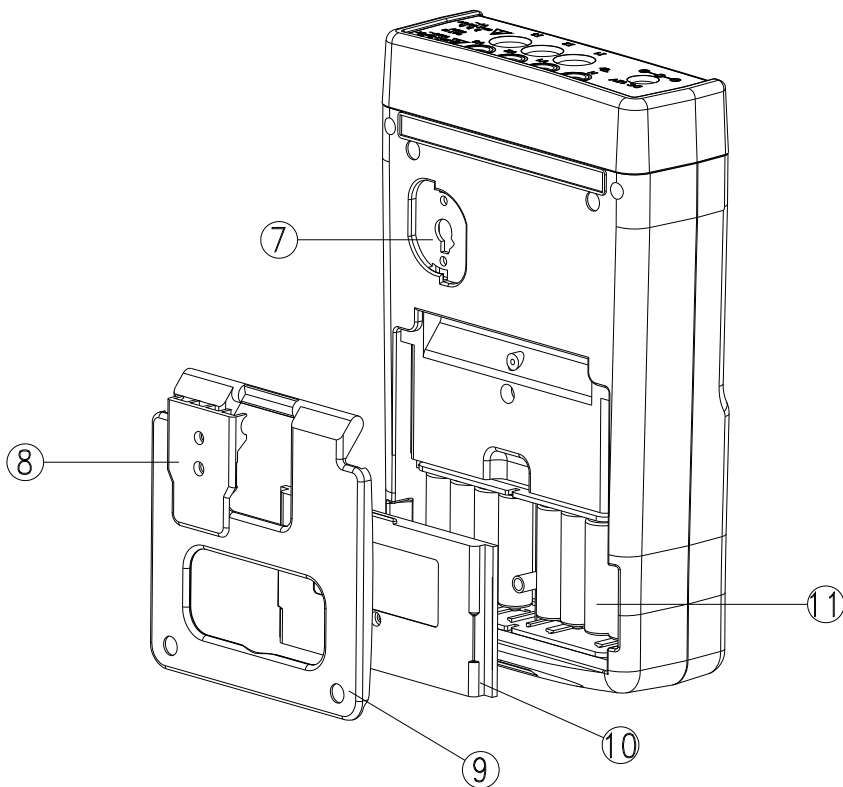

1. Input Terminal for Neutral Line (Voltage)
2. Voltage Input Terminals for Each Phase (V1, V2, V3)
3. External DC Input (The AC adaptor must be 600V isolated)
4. Current Input Terminals for Each Phase (I1, I2, I3)
5. LCD Display
6. Buttons
7. RS-232C Window
8. Stand Holder
9. Stand
10. Battery Cover
11. Battery Compartment

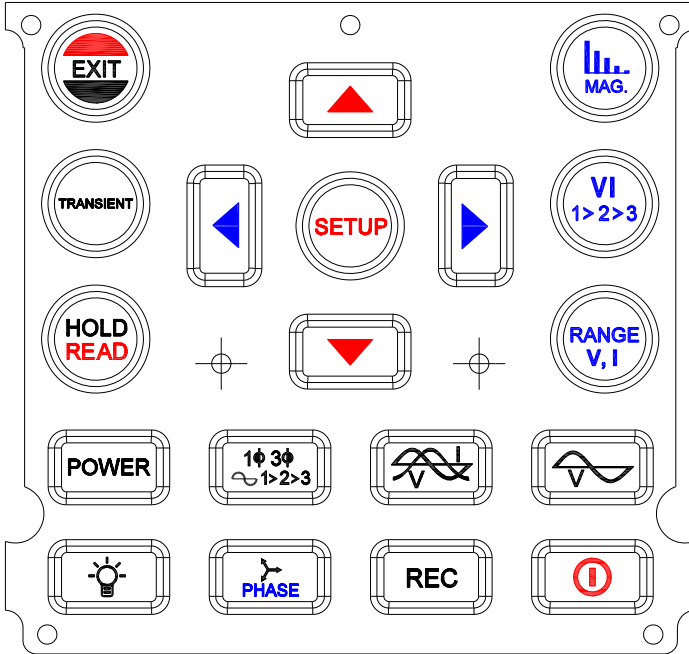

Press this button to exit transient detection or to exit SETUP menu.



Press this button to perform transient detection.



Press this button to hold the data displayed in LCD. Press this button and then REC button to record the displayed data. Press HOLD button again to continue operation.



Press this button to start measurement of harmonics in magnitude.

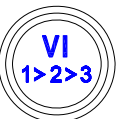

Press this button to select V1, I1, V2, I2, V3, or I3 for harmonics analysis



Press this button for the voltage or current input range



Press this button to enter SETUP mode and then select the parameter to be adjusted

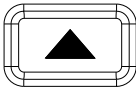

Press this button to increment value by one. Hold the button for two seconds or more to speed up the increment.

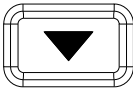

Press this button to decrement value by one. Hold the button for two seconds or more to speed up the decrement.

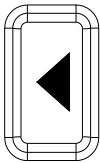

In the mode of harmonic analysis, press this button to move the cursor left to the previous order.

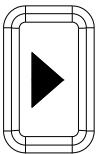

In the mode of harmonic analysis, press this button to move the cursor right to the next order.



Press this button to start data logging. Press it again to stop data logging. The sampling interval is displayed in LCD pointed by SEC

indicator.

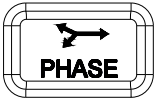

In the mode of power measurement, press this button to display the phasor diagram. In the mode of harmonic analysis, press this button to display phase angle instead of magnitude.

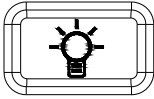

Press this button to turn the back light on. Press it again to turn the back light off.

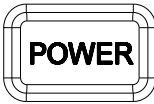

Press this button to start measurement of power parameters.

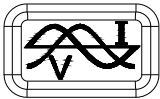

Press this button to display waveform of voltage and current.

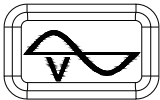

Press this button to display waveform of voltage only

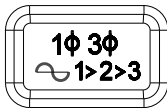

In the mode of power parameter measurement, press this button to select appropriate system (3P4W, 3P3W, 1P2W or 1P3W). In the mode of displaying waveform, press this button to select (V1, I1), (V2, I2), or (V3, I3).

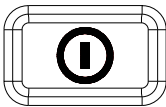

Press this button to turn the power on or off.

PCE-6801 Current Probe (100A)

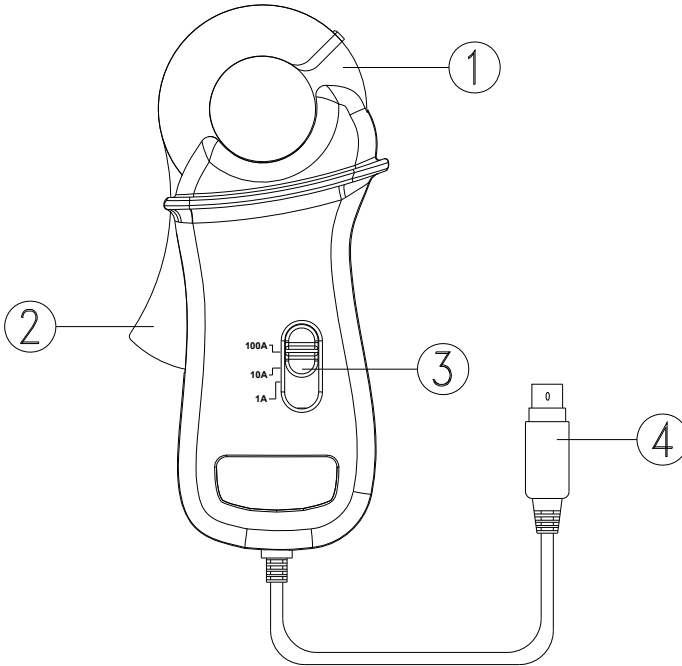

- 1. Jaw Assembly
- 2. Trigger
- 3. Range Selector
- 4. 6 pin mini DIN connector

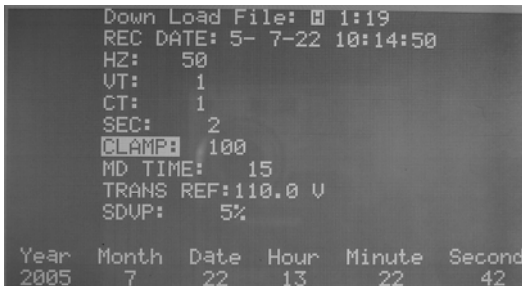

NOTE: To setup 100A current probe as selected probe, press the **SETUP** button to select CLAMP. When the CLAMP is reverse video, press the **▲** or **▼** button to select 100.

PCE-6802 Current Probe (1000A)

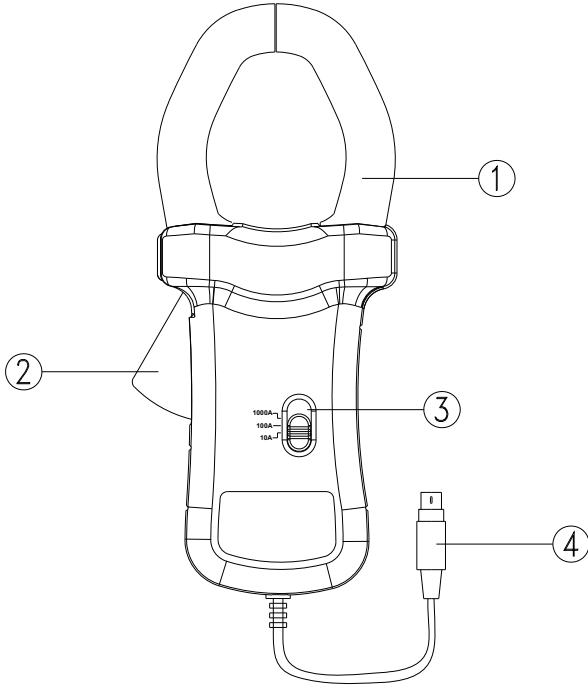

- 1. Jaw Assembly
- 2. Trigger
- 3. Range Selector
- 4. 6 pin mini DIN connector

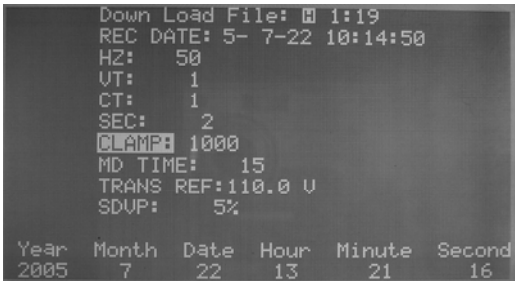

NOTE: To setup 1000A current probe as selected probe, press the SETUP button to select CLAMP. When the CLAMP is reverse video, press the ▲ or ▼ button to select 1000.

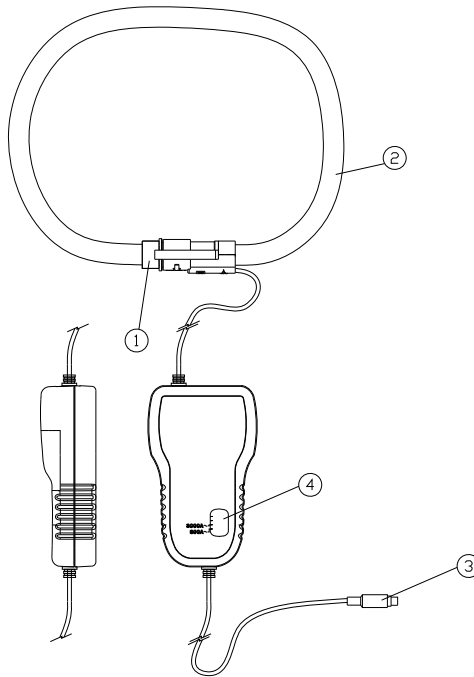

1. Coupling Assembly
2. Flexible Loop
3. Mini-DIN connector for Output
4. Output Range Select Switch

```

Down Load File: 1:19
REC DATE: 5- 7-22 10:14:50
HZ: 50
VT: 1
CT: 1
SEC: 2
CLAMP: 3000
MD TIME: 15
TRANS REF: 110.0 U
SDUP: 5%

Year  Month  Date  Hour  Minute  Second
2005   7    22   13    21     16

```

III. OPERATING INSTRUCTIONS

NOTE:

Select the correct CLAMP in the SETUP menu. When the current probe is connected to the power analyzer, power analyzer will automatically detect the range selected.

NOTE:

Select the correct frequency (Hz) in the SETUP menu.

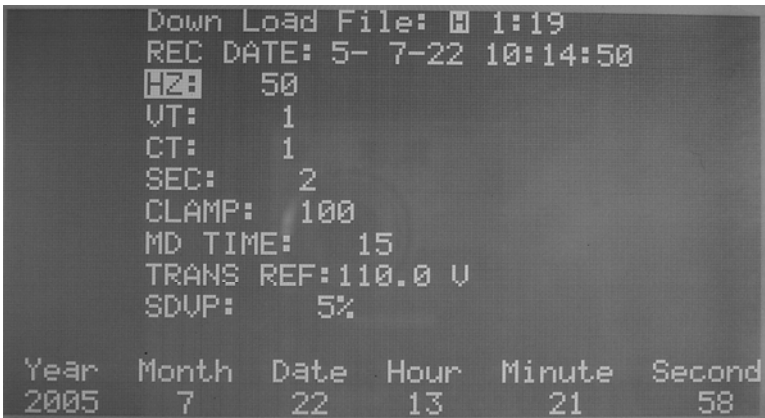

Down Load File: 1:19
REC DATE: 5- 7-22 10:14:50
HZ: 50
VT: 1
CT: 1
SEC: 2
CLAMP: 100
MD TIME: 15
TRANS REF:110.0 V
SDUP: 5%

Year	Month	Date	Hour	Minute	Second
2005	7	22	13	21	58

WARNING:

All the current probes connected to the power analyzer must be of the same model and same range. Mixed models and different ranges selected will cause incorrect result of measurement.

NOTE:

Please pay special attention to the **flexible current probes (model 3007/3009)** connected to the power analyzer.

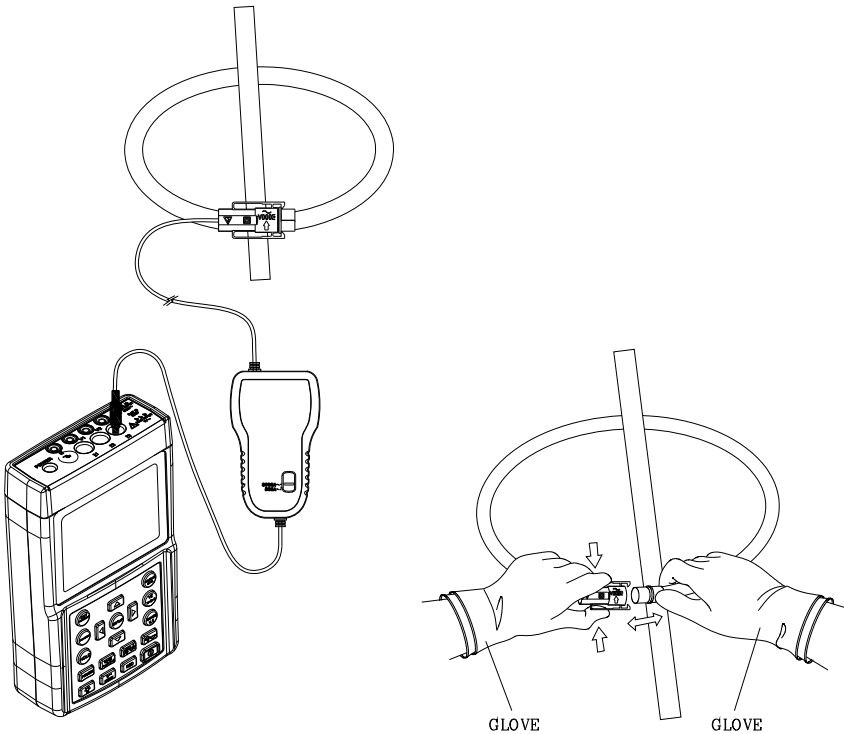

1. Connect the flexible probe around the conductor.
2. Make sure the current flowing direction is in consistent with the arrow marked on the probe coupling. If the flexible current probe is connected in the right orientation, the correct phase will be displayed in the oscilloscope.
3. Keep the probe coupling more than 25mm away from the conductor.

WARNING: Always wear appropriate gloves in operation.

III.0. Set up before operation

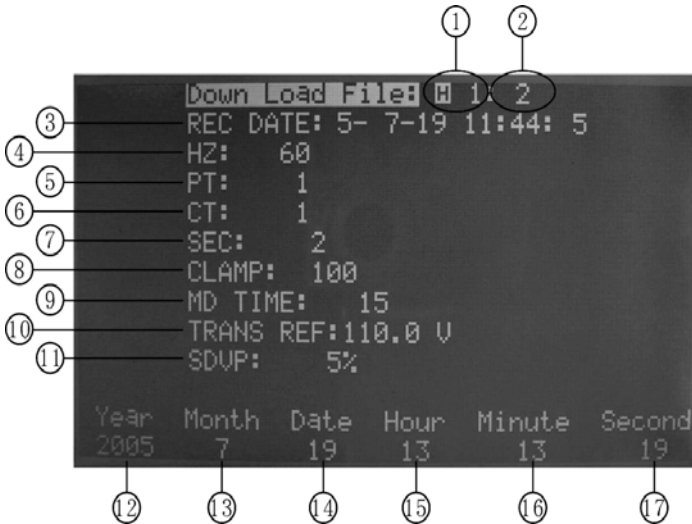

a. Press **SETUP** button to enter setup screen. Press **SETUP** again to select the item for setting (the selected item will be displayed in reverse video).

b. After selecting the item, press **▲** or **▼** buttons to set up its value.

c. After finishing setting up, press **EXIT** button to leave setup mode.

1. Select the data for download:

H means harmonics;

H in reverse video means HOLD screen data (if the data is the one you want, you can press **HOLD** button to display the data, and press **HOLD** button again to exit);

P means power data which can be a reference for downloading, the data in order is 0~84.

2. Shows the total logged data in the analyzer: max. 85 logging data.

3. **REC DATE:** shows the starting logging time of the 1st downloaded file.

4. **Hz:** set up the frequency (50, 60 or AUTO) of the system.
5. **PT:** set up PT value.
6. **CT:** set up CT value.
7. **SEC:** set up the interval seconds of logged data.
8. **CLAMP:** set up the clamps selected (100A, 1000A, 3000A or 1200A).
9. **MD TIME:** set up the time of Maximum Demand (1~60 minutes).
10. **TRANS REF:** set up the transient voltage (which will be automatically changed in accordance with PT).
11. **SDVP:** set up upper and lower limits % of transient voltage detection.
12. **YEAR:** Set up “year” of calendar clock.
13. **MONTH:** Set up “month” of calendar clock.
14. **DATE:** Set up “date” of calendar clock.
15. **HOUR:** Set up “hour” of calendar clock.
16. **MINUTE:** Set up “minute” of calendar clock.
17. **SECOND:** Second can be displayed only (it can not be adjusted).

III.1. Power Quality of a 3 Phase 4 Wire (3P4W) System

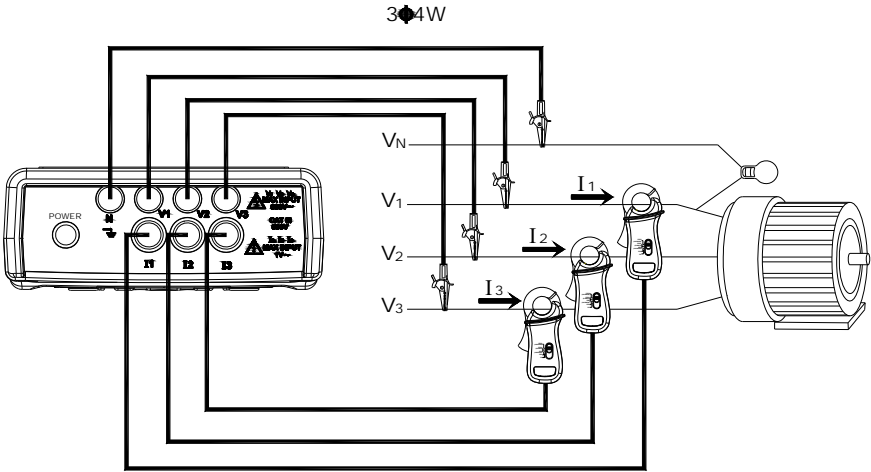

a. Turn the power on. Press the **POWER** and the **1Φ3Φ** buttons to select

the 3P4W system. The type of system will be displayed at the left bottom corner in the LCD.

- b. Connect the four test leads to the voltage terminals V1, V2, V3 and the V_N (Neutral) of the system.
- c. Connect the test leads to L1, L2, and L3 of the 3P4W system.
- d. Connect the three current probes to the power analyzer input terminal I1, I2, and I3.
- e. Clamp on to the L1, L2, and L3 of the 3P4W system. Make sure the current flows from the front of the current probe to the back of it.
- f. All parameters of the system will be shown in LCD.

U12: 381.6 V	U13: 219.9 V	I1: 799.1mA
U23: 381.1 V	U2: 219.9 V	I2: 800.1mA
U31: 379.1 V	U3: 219.5 V	I3: 800.7mA
P1: 156.5 W	S1: 175.7 VA	Q1: - 79.8 VAR
P2: 154.0 W	S2: 175.9 VA	Q2: - 84.9 VAR
P3: 153.8 W	S3: 175.7 VA	Q3: - 84.9 VAR
PΣ: 464.4 W	SΣ: 527.1 VA	QΣ: -249.4 VAR
PFΣ: 0.88	PF1: 0.89	PF2: 0.87
PFH: 0.88	φ1: - 26.9°	φ2: - 29.0°
φ3: - 29.0°		
WH: 127.7 WH	SH: 144.8 VAH	QH: 68.2 VARH
HZ: 50.0 Hz	MD: 436.5 VA	MD: 385.1 W
3φ4W	SEC: 2	CT: 1
	UT: 1	

For the meaning of each parameter, refer to XIV. NOMENCLATURE.

III.2 Power Quality of a 3 Phase 3 Wire (3P3W) System



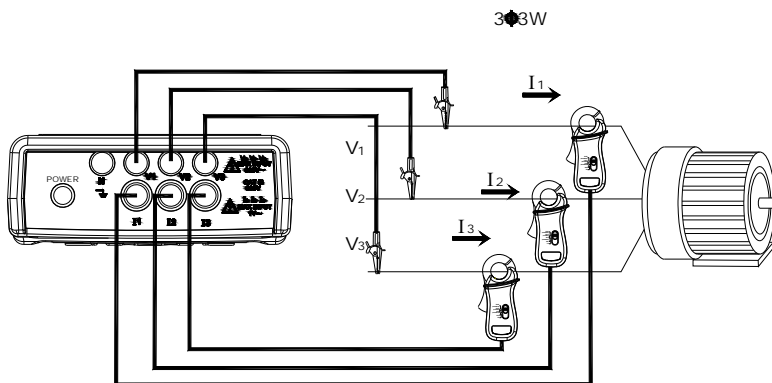

- Turn the power on. Press the **POWER** and the **1Φ3Φ** buttons to select the 3P3W system. The type of system will be displayed at the bottom right of the LCD.
- Connect the three test leads to the voltage terminals L1, L2, and L3 of the system.
- Connect the three current probes to the power analyzer input terminal I1, I2, and I3.
- Clamp on to the L1, L2, and L3. Make sure the current flows from the front of the current probe to the back of it.
- All parameters of the system will be shown in LCD



For the meaning of each parameter, refer to XIV. NOMENCLATURE.

III.3 Power Quality of a Single Phase (1P2W) System

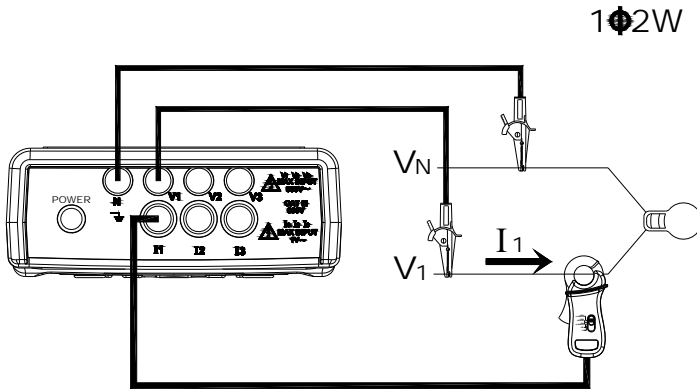

- Turn the power on. Press the **POWER** and the **1Φ3Φ** buttons to select the 1P2W system. The type of system will be displayed at the bottom right of the LCD
- Connect the two test leads to the voltage terminals L1 and V_N (Neutral) of the system.
- Connect one current probe to the power analyzer input terminal I1.
- Clamp on to the L1. Make sure the current flows from the front of the current probe to the back of it.
- All following parameters of the system will be shown in LCD



For the meaning of each parameter, refer to XIV. NOMENCLATURE.

III.4 Power Quality of a 1 Phase 3 Wire (1P3W) System

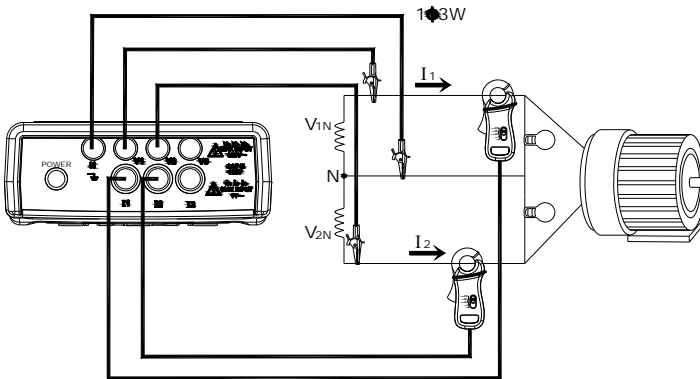

- Turn the power on. Press the **POWER** and the **1Φ3Φ** buttons to select the 1P3W system. The type of system will be displayed at the bottom right of the LCD.
- Connect the three test leads to the voltage terminals L1, L2 and V_N (Neutral) of the system.
- Connect the two current probes to the power analyzer input terminal I1 and I2.
- Clamp on to the L1 and L2. Make sure the current flows from the front of the current probe to the back of it.
- All parameters of the system will be shown in LCD

V1: 220.0 V	I1: 797.7 mA		
V2: 220.0 V	I2: 800.7 mA		
P1: 156.4 W	S1: 175.4 VA	Q1: -79.3 VAR	
P2: 154.2 W	S2: 176.1 VA	Q2: -85.0 VAR	
PΣ: 310.6 W	SΣ: 351.3 VA	QΣ: -164.3 VAR	
PF2: 0.88	PF1: 0.89	PF2: 0.87	
PFH: 0.88	φ1: -27.1°	φ2: -29.0°	
WH: 4.3 WH	SH: 4.8 VAH	QH: 2.2 VARH	
HZ: 50.0 Hz	MD: VA	MD: W -15	
1Φ3W	SEC: 2	CT: 1	UT: 1

For the meaning of each parameter, refer to XIV. NOMENCLATURE.

III.5 Measurement of a System with CT or VT

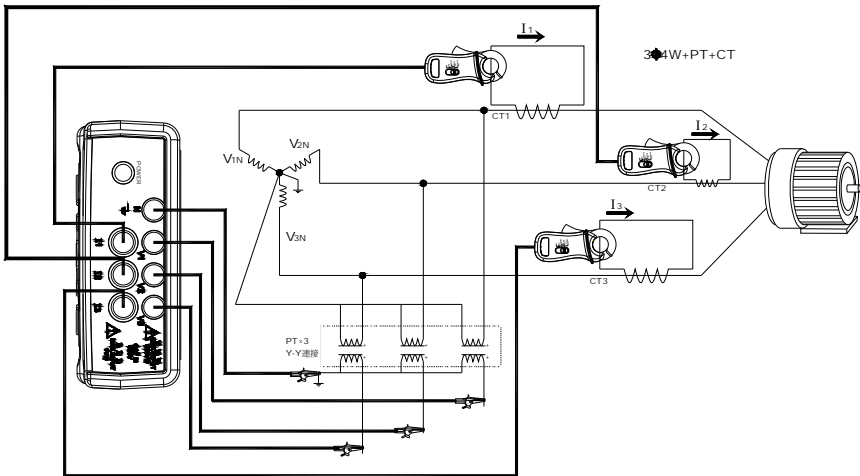

- Turn the power on. Press the POWER and the **1Φ3Φ** buttons to select the 3P4W system. The type of system will be displayed at the bottom right of the LCD.
- Connect the four test leads to the secondary voltage terminals L1, L2, L3 and the V_N (Neutral) of the system.
- Clamp on to the secondary coils of L1, L2, and L3. Make sure the current flows from the front of the current probe to the back of it.
- Press the **SETUP** button and the CT symbol will be shown in reverse video in LCD.
- Press the ▲ or ▼ buttons to increment or decrement the RATIO specified by the CT.

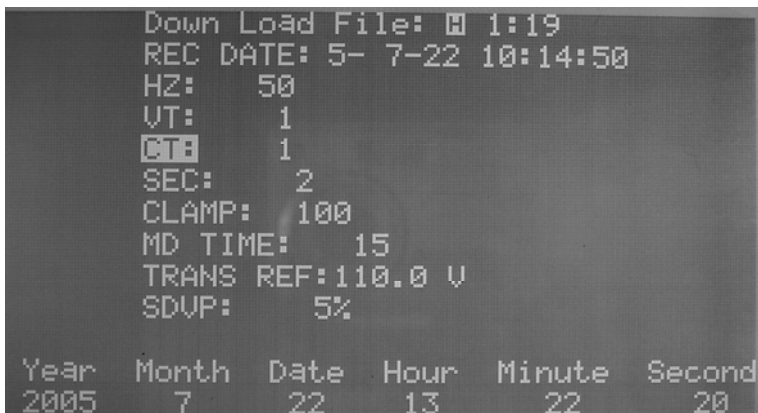

- f. Press the **SETUP** button and the VT symbol will be shown in reverse video in LCD.
- g. Press the **▲** or **▼** buttons to increment or decrement the RATIO specified by the VT.

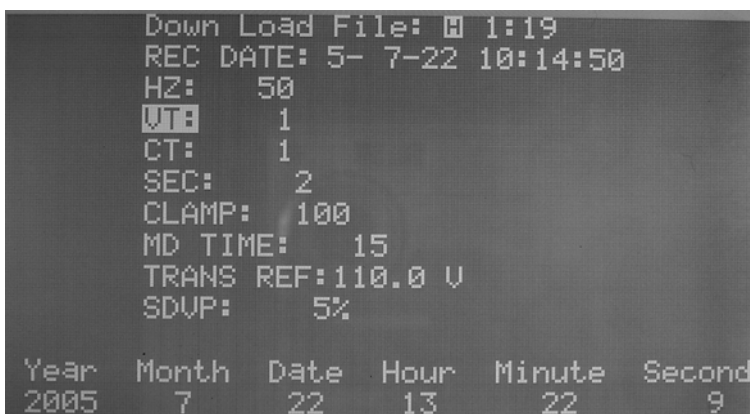

- h. Press **EXIT** to return to POWER mode. All the parameters of the system will be shown in LCD

For the meaning of each parameter, refer to XIV. NOMENCLATURE.

III.6 Harmonic Analysis of Voltage or Current

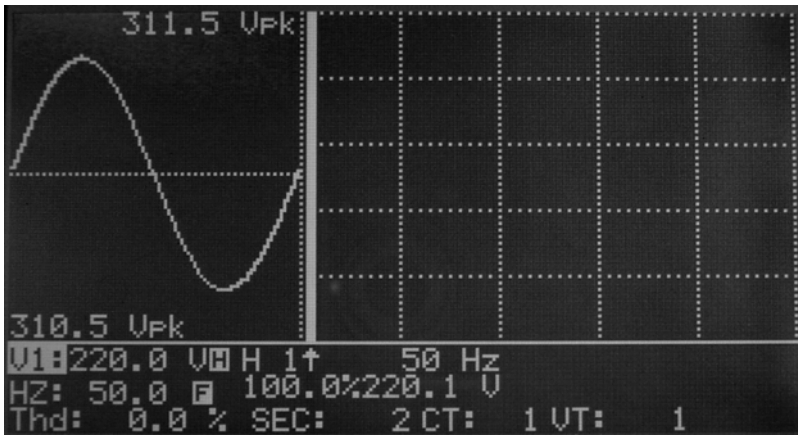

(Normal Voltage without Distortion and Harmonics)

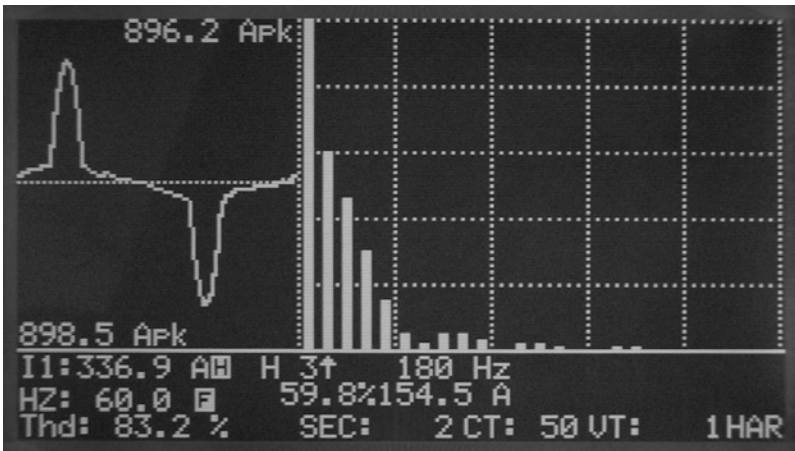

(Distorted Current with Harmonics)

- a. Set up the analyzer for measurement of any power system (3P4W, 3P3W, 1P2W, or 1P3W). To see the harmonic analysis of voltage or current, users can press the **MAG** button.

- b. Once the **MAG** button is pressed, the waveform will be shown in the left part in LCD, and the 1st to 50th order harmonics will be shown in the right part in LCD.
- c. The positive and negative peak values will be shown in the waveform (Vpk).
- d. The true RMS value and total harmonic distortion (THD-F) of voltage or current will be shown under the waveform.
- e. The cursor (↑ arrow) will point to the current order of harmonics. The frequency (HZ) will be displayed next to the cursor. The percentage of harmonics (%) will be displayed below the cursor. The magnitude of the harmonics (V or A) or phase angle will be displayed next to the %.
- f. To move the cursor to next harmonics, press the ◀ or ▶ button.
- g. To see the next page of 51st to 99th order, press the ▶ button to pass 50th order or press the ◀ button to pass 1st order.

NOTE:

If the waveform is chopped off at the peak or too small in the LCD, press the RANGE button to select HIGH or LOW range for better display. The range indicator is a symbol after the unit of RMS value, L or H.

III.7 Display the Phase Angle of Harmonics

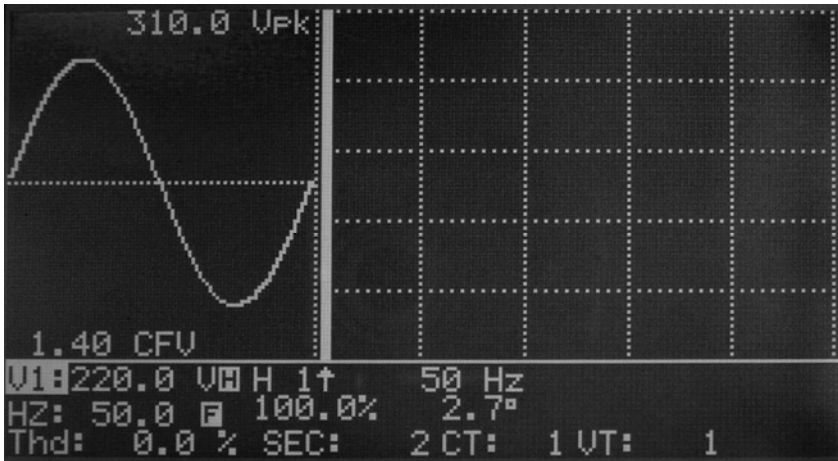

When the **MAG** is pressed the magnitude of each harmonics is displayed. To review the phase angle of each harmonic, users can press the **PHASE** button. The phase angle shall be displayed next to the %. This phase angle is measured from the sampled waveform. It may not be 0 for V1. The rest of the phase angle (V2, V3, I1, I2, and I3) is sampled with respect to V1.

NOTE:

If the waveform is chopped off at the peak or too small in the LCD, press the **RANGE** button to select HIGH or LOW range for better display. The range indicator is a symbol after the unit of RMS value, L or H.

III.8 Measurement of Maximum Demand

1. Set the time interval for maximum demand (refer to section VII)
2. The analyzer will integrate the KW and KVA over the specified interval.
3. The maximum demand (MD) will be updated if new demand is greater than the previous value.

In the following example, the maximum demand is 527.4VA and 527.4W. The time interval for maximum demand is 2 minutes.

U1: 381.8 V	U1: 220.0 V	I1: 798.5mA
U2: 380.8 V	U2: 220.0 V	I2: 800.7mA
U3: 379.7 V	U3: 219.6 V	I3: 801.7mA
P1: 175.4 W	S1: 175.6 VA	Q1: 8.3 VAR
P2: 176.1 W	S2: 176.1 VA	Q2: 0.0 VAR
P3: 176.0 W	S3: 176.0 VA	Q3: 0.0 VAR
PΣ: 527.5 W	SΣ: 527.5 VA	QΣ: 8.3 VAR
PFΣ: 1.00	PF1: 0.99	PF2: 1.00
PF3: 1.00		
PFH: 0.98	φ1: 2.9°	φ2: 1.0°
		φ3: 0.8°
WH: 60.7 WH	SH: 61.9 VAH	QH: 3.9 VARH
HZ: 50.0 Hz	MD: 527.4 VA	MD: 527.4 W - 2
3φ4W	SEC: 2	CT: 1
	UT: 1	

III.9 Waveform of Voltage and Current

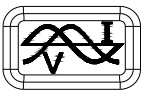
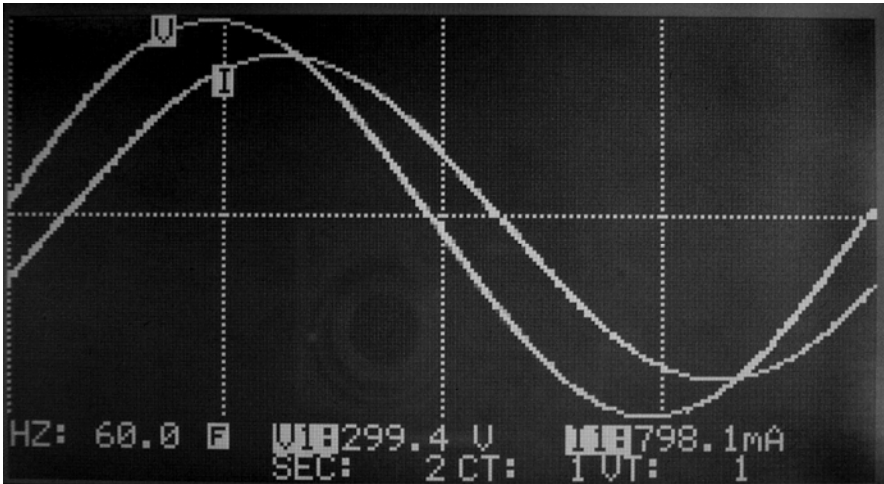

Press this button to display waveform of voltage and current at the same time.

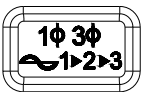

Press this button to select different inputs (V1, I1), (V2, I2), or (V3, I3).

NOTE:

The triggering point is the zero crossing point of V1 for V2, V3, I2, and I3. The triggering point for I1 is its own zero crossing point in case V1 is not present.

NOTE:

In the mode of displaying waveform, one period/cycle of 1024 data is displayed.

III.10 Waveform of Voltage Only

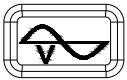
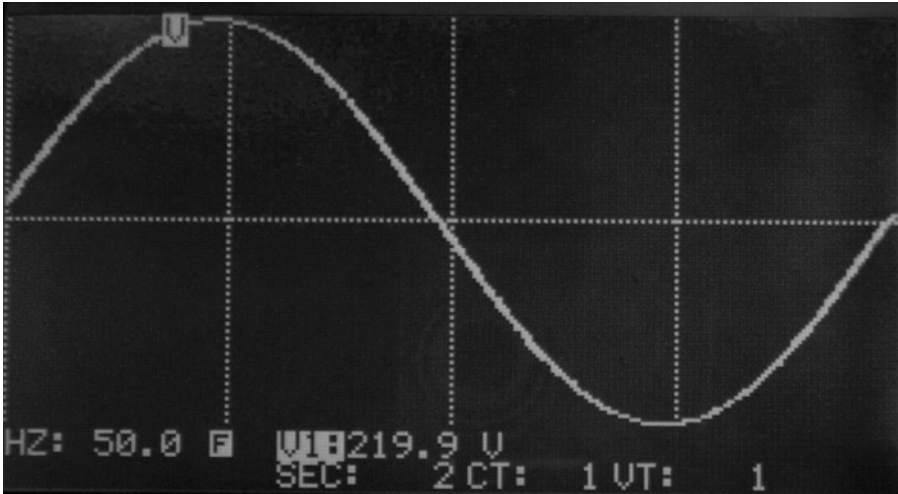

Press this button to display voltage waveform only. The true RMS value of voltage will be displayed at the bottom in LCD.

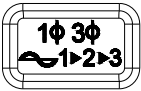

Press this button to select V1, V2, or V3.

NOTE:

The triggering point is the zero crossing point of V1 for V2 and V3.

NOTE:

In the mode of displaying waveform, one period/cycle of 1024 data is displayed.

III.11 Graphic Phasor Diagram

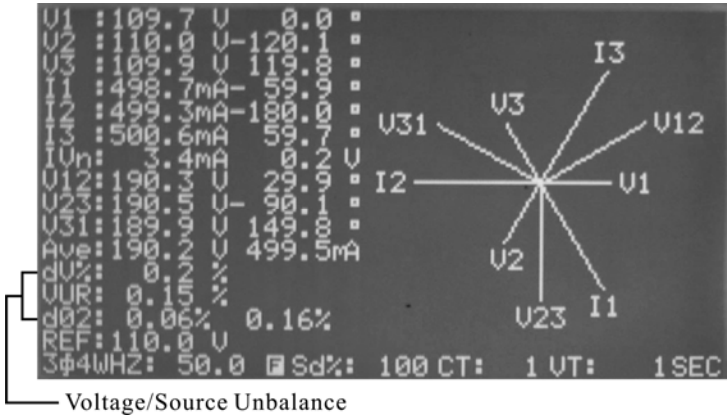

Press this button to display the phasor diagram.

The voltages and currents will be displayed in phasor format (magnitude, angle). V1 will be referred as reference. The angle of V1 is always 0. The phase angles of V2, V3, I1, I2, and I3 will be displayed with respect to V1. V1, V2, V3, I1, I2, I3, V12, V23, and V31 will be displayed in vector form graphically.

V1, V2, V3: Phase voltages in phasor format with respect to V1

I1, I2, I3: Line currents in phasor format with respect to V1.

I_{0n}: Calculated voltage and current of neutral with respect to ground.

V12, V23, V31: Line voltage in phasor format with respect to V1.

Ave: Average of line voltages V12, V23, and V31 and line current I1, I2, and I3

dV%: Historical maximum % value of

$$(\text{Max}(V1, V2, V3) - \text{Min}(V1, V2, V3)) / \text{Min}(V1, V2, V3) * 100\%$$

VUR: Voltage Unbalance Ratio

d02: The first number is Zero Sequence Unbalance Ratio in % (d0) of voltage.

The second number is the Negative Sequence Unbalance Ratio in % (d2) of voltage. When VUR is displayed before d02, d02 represents the Zero and Negative Sequence Unbalance Ratios for voltage.

REF: nominal voltage for transient detection reference

Sd%: threshold in % for transient detection with respect to nominal voltage (REF).

NOTE:

The phasor is drawn only when the reading is more than 200 counts. And if the reading of V is zero, then phasor of current will not be drawn.

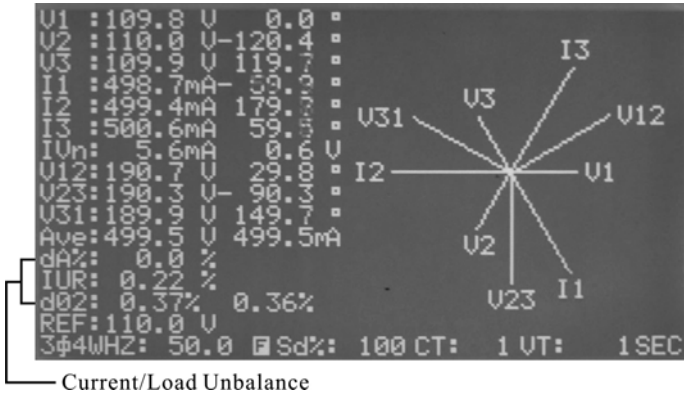

Press this button to change the display from VUR to IUR

dA%: Historical maximum % value of

$$\frac{(\text{Max}(I1, I2, I3) - \text{Min}(I1, I2, I3))}{\text{Min}(I1, I2, I3)} * 100\%$$

IUR: Current Unbalance Ratio

d02: The first number is Zero Sequence Unbalance Ratio in % (d0) of current, The second number is the Negative Sequence Unbalance Ratio in % (d2) of current. When IUR is displayed before d02, d02 represents the Zero (d0) and Negative (d2) Sequence Unbalance Ratios for current.

REF: nominal voltage for transient detection reference

Sd%: threshold in % for transient detection with respect to nominal voltage (REF).

NOTE:

If the voltage of L1, L2, and L3 is not connected in right sequence, the analyzer will show L1-3-2 in the right top corner, and beep to warn the users of incorrect phase sequence.

III.12 Phase Sequence of a 3 Phase System

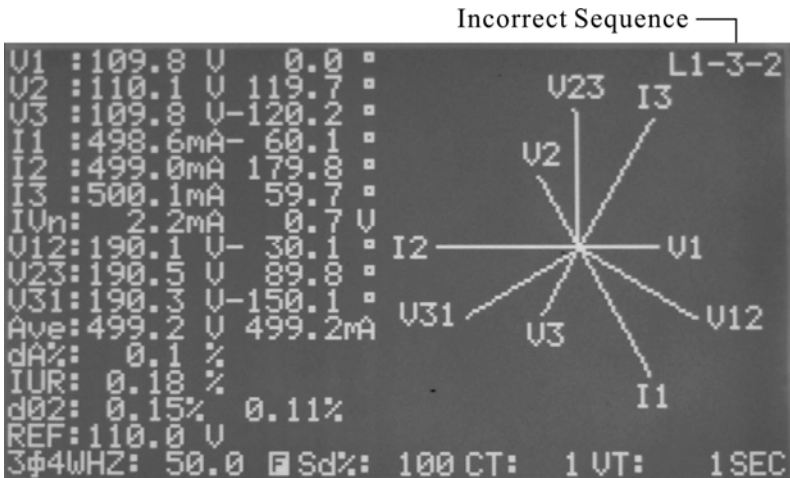

Press this button to display phasor diagram.

In this mode, the analyzer also detects the correctness of the phase sequence. If the voltage of L1, L2, and L3 is not connected in right sequence, the analyzer will show L1-3-2 in the right top corner, and beep to warn the users of incorrect phase sequence.

III.13 Balanced and Unbalanced 3 Phase (3P3W, 3P4W) Power Source System

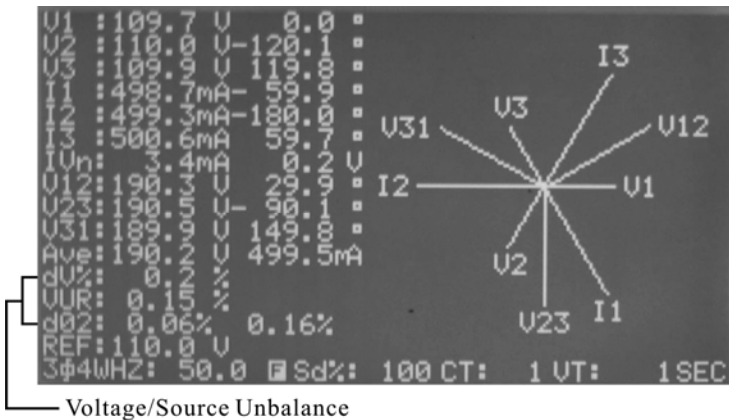

In order to check if a system is balanced, press this button to display the phasor diagram with the VUR displayed.

Balanced System

If a 3 phase power source system is balanced, the parameters should be as following:

$$V1 = V2 = V3$$

$$V12 = V23 = V31$$

The phase angle of phasor V2 = -120

The phase angle of phasor V3 = 120

Vn (voltage of neutral with respect to ground) = 0V

$$VUR = 0\%$$

$$d0\% = 0\%$$

$$d2\% = 0\%$$

Unbalanced System

If the values are different from the numbers above, then we can say it is an unbalanced power source system. The magnitude of the difference can be used as an indication of an unbalanced power source system. The larger the difference, the more unbalanced the system is.

III.14 Balanced and Unbalanced 3 Phase (3P3W or 3P4W) Load System

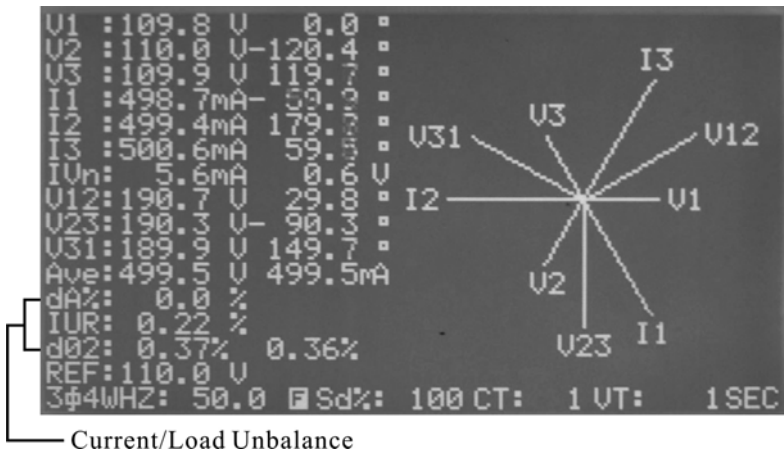

In order to check if current of a system is balanced, press the button twice to display the phasor diagram with the IUR displayed.

Balanced System

If a 3 phase load system is balanced, the parameters should be as following:

$$I_1 = I_2 = I_3$$

The phase angle of phasors I2 and I1 ($I_2 \pm I_1$) = ± 120

The phase angle of phasors I3 and I2 ($I_3 \pm I_2$) = ± 120

In (current of neutral) = 0A

$$IUR = 0\%$$

$$d0\% = 0\%$$

$$d2\% = 0\%$$

Unbalanced System

If the values are different from the numbers above, then we can say it is an unbalanced load system. The magnitude of the difference can be used as an indication of an unbalanced power source system. The larger the difference, the more unbalanced the load is.

III.15 Transient Capture Setup (Dips, Swells, Outage)

NO.	ELAPSED TIME (DAYS:HOURS:MINUTES)		CYCLES	TRANSIENT CODE
1	0d 2: 1	92 1	2	2d 9: 2
2	8d12:21	38 1	4	12d 8: 3
3	21d 6:39	50 1	6	38d 6: 50
4	45d12:59	212 1	8	62d10:45
5				62 1
6				45 1
7				39 1
8				59 1

REF: 100.0 U
 3φ4WHz: 50.0 Sd%: 10 CT: 1 UT: 1MD

NOMINAL VOLTAGE THRESHOLD(1-100%)

1. Press button  to enter the mode of PHASOR DIAGRAM.

2. Press the **SETUP** button to let TRANS REF is displayed in reverse video.

```

Down Load File: 1:19
REC DATE: 5- 7-22 10:14:50
HZ: 50
UT: 1
CT: 1
SEC: 2
CLAMP: 100
MD TIME: 15
TRANS REF: 110.0 U
SDVP: 5%

Year  Month  Date  Hour  Minute  Second
2005   7     22   13    23     5
  
```

3. Press the ▲ or ▼ buttons to increment or decrement nominal voltage as reference. To exit, press the **EXIT** button.

4. Press the **SETUP** button to let SDVP displayed in reverse video.

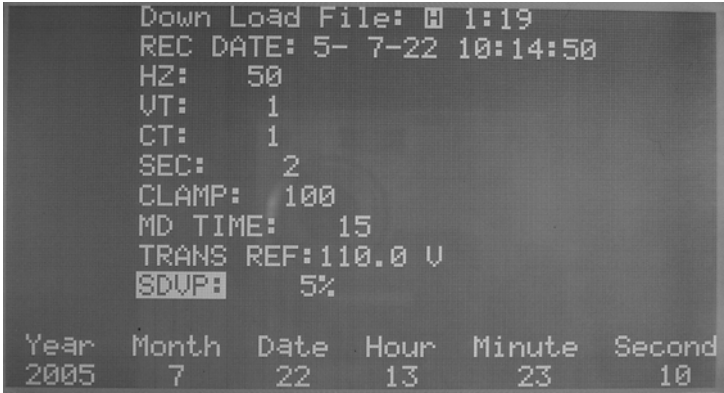

5. Press the ▲ or ▼ button to increment or decrement threshold in % (SDVP). To exit, press the **EXIT** button.
6. Press the **TRANSIENT** button to start operation of “Transient Capture”.
7. The backlight will be turned off when the **TRANSIENT** button is pressed.
8. If the analyzer captures any transient events (DIP, SWELL, or OUTAGE), the backlight will be turned on. User can press the **TRANSIENT** button to review the TRANSIENT events recorded.
9. To exit TRANSIENT CAPTURE, press the **EXIT** button.

Definition of SWELL, DIP, and OUTAGE:

SWELL: $V_{RMS} > [V_{REF} + (V_{REF} * SD\%)]$

Code for SWELL: 1

If true RMS value of either phase (V1, V2, or V3) rises above the nominal value plus the threshold (REF + SD%), it is regarded as SWELL. The code for SWELL is 1.

DIP: $V_{RMS} < [V_{REF} - (V_{REF} * SD\%)]$

Code for DIP: 2

If the true RMS value of either phase (V1, V2, or V3) falls below the nominal value plus the threshold, it is regarded as DIP. The code for DIP is 2.

OUTAGE: $V_{RMS} < 30 \text{ to } 40V$

Code for OUTAGE: 4

If the true RMS value of either phase is less than 30 to 40V, it is regarded as OUTAGE. The code for OUTAGE is 4.

Code Table:

	SWELL	DIP	OUTAGE	COMMENT
CODE	1	2	4	Codes can be added together

DISPLAY FORMAT:

First column: sequential number of events.

Second column: elapsed time since the time of start. The elapsed time format is (DAYS, HOURS, MINUTES). The maximum time is 99 day 24 hours 60 minutes.

The third column: number of cycles.

The fourth column: code of transient events. There might be more than one transient condition occurs in one event.

NOTE: In the mode of TRANSIENT CAPTURE, the analyzer takes 128 samples of each cycle for each phase continuously.

NOTE: When the users press the **TRANSIENT** button to review the recorded events, the analyzer stops capture operation until the **TRANSIENT** is pressed again. The timer is also stopped when users press the **TRANSIENT** button. So the time stamp is not correct when users press the **TRANSIENT** button to resume operation.

NOTE: The analyzer can record up to 28 events. When the analyzer has recorded 28 events, it stops the capture operation, turns the backlight on, and displays the 28 transient events.

NOTE: The code can be added together to indicate two or three conditions. For example, if code is 6, that means DIP and OUTAGE (2+4).

NOTE: The longest duration for capture operation is 99 days. So users should use external 12V DC power adaptor for capture operation.

WARNING: Users must select 50 or 60 Hz for transient capture. If users select AUTO for frequency, the unit will not allow users to enter the TRANSIENT capture, and will beep to warn users.

III.16 Download Transient Data

When users press the TRANSIENT button to display CAPTURED EVENTS, the data is also output through RS-232 at the same time.

The data output is in the same format as in LCD in ASCII format
YEAR MONTH DAY HOUR MINUTE SECOND CT REF CODE
01 ELAPSED_TIME CYCLES CODE
02 ELAPSED_TIME CYCLES CODE
03 ELAPSED_TIME CYCLES CODE
04 ELAPSED_TIME CYCLES CODE

...

<p>NOTE: When users download data in the office, one additional event will be captured due to no input connected. The additional (last) event should show:</p> <ol style="list-style-type: none">1. Elapsed time is reset to 0.2. Transient event is LO and OUT.
--

III.17 Data Logging of Power Data (3P4W, 3P3W, 1P2W, 1P3W)

1. Set the sampling time of data logging.
2. Press the **POWER** button to enter mode of power measurement.
3. Press the **1Φ3Φ** button to select appropriate system (3P4W, 3P3W, 1P3W, or 1P2W).
4. Press the **REC** button to start data logging. A **REC** symbol will be displayed at the bottom line in LCD.

If the memory is full, a **FULL** symbol will display at the bottom line in LCD, and the buzzer will last 3 seconds. Now the recording function is disabled, i.e. pressing the **REC** button won't work.

5. To stop data logging, press the **REC** button again.

NOTE:

Do not communicate with PC during data logging.

WARNING:

If there is no input at V1, then the sampling time could be longer than the set value.

WARNING:

If the unit detects battery low during the period of logging, Data Logging will be ended automatically. So if users want to log data for a longer period, please be sure to connect the AC power adapters (which are provided with the analyzers).

III.18 Download Power Data

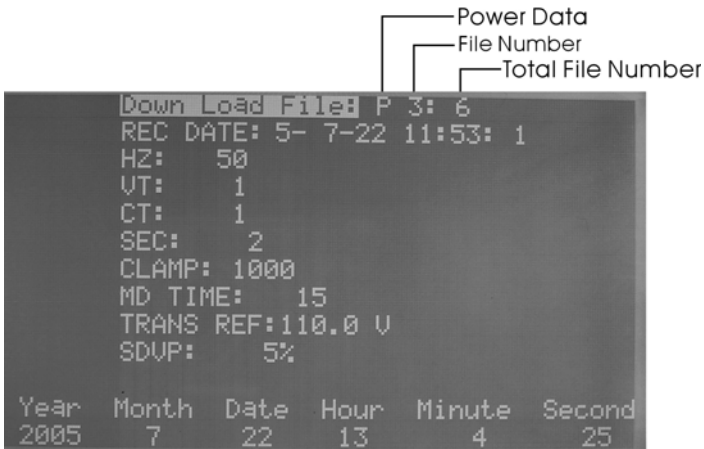

1. Press the **SETUP** button.
2. The “Down Load File” will be shown in reverse video.
3. Press the ▲ or ▼ button to select file number.
4. If the data stored in a selected file is power data, a leading symbol “P” will be shown in front of the file number
5. Press EXIT button.
6. When the unit receives a CTRL D command through the RS-232C port, it will down load stored power data.

NOTE:

In the setup mode, the unit will not accept any command through RS-232C port. To down load data, users must press the EXIT button to return to normal measurement mode.

III.19 Data Logging of Harmonics

1. Set the sampling time of data logging/
2. Press **MAG** button to enter mode of harmonics measurement.
3. Press the **V** button to select desired input (V1, I1, V2, I2, V3, or I3).
4. Press the **REC** button to start data logging. A **REC** symbol will be displayed at the bottom line in LCD.

If the memory is full, a **FULL** symbol will display at the bottom line in LCD, and the buzzer will last 3 seconds. Now the recording function is disabled, i.e. pressing the **REC** button won't work.

5. To stop data logging, press the **REC** button again.

NOTE:

Do not communicate with PC during data logging.

WARNING:

If there is no input at V1, then the logging time will be incorrect.

WARNING:

If the unit detects battery low during the period of logging, Data Logging will be ended automatically.

III.20 Download Harmonics Data

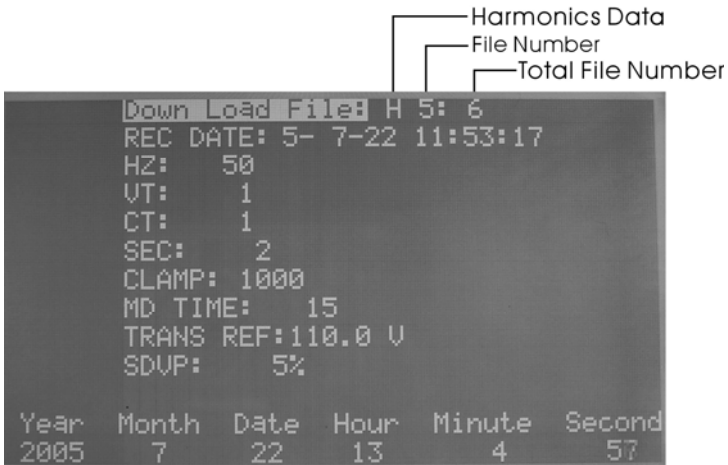

1. Press the **SETUP** button.
2. The “Down Load File” will be shown in reverse video.
3. Press the ▲ or ▼ button to select file number.
4. If the data stored in a selected file is harmonics data, a leading symbol “H” will be shown in front of the file number.
5. Press **EXIT** button.
6. When the unit receives a CTRL+D command through the RS-232C port, it will down load stored harmonics data.

NOTE:

In the setup mode, the unit will not accept any command through RS-232C port. To down load data, users must press the **EXIT** button to return to normal measurement mode.

III.21 Clear Memory of Data Logging

To clear all data memory of the unit, hold the REC button and turn the power on.

IV. HARDCOPY OF SCREEN

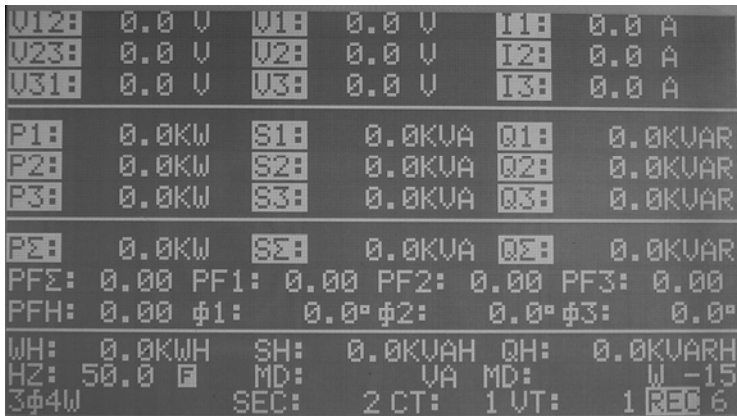

File Number

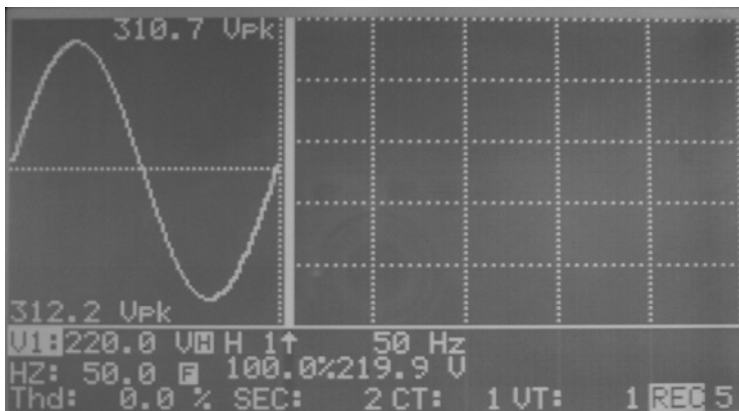

File Number

1. Press the **HOLD/READ** button.
2. Press the **REC** button. It takes few seconds to hardcopy the screen, and store the screen in an internal file. The LCD will show **REC** in reverse video when in operation. The number following the REC is the file number.
3. Users can store up to 85 screens if no power or harmonics data is stored.

V. READ THE SAVED SCREEN

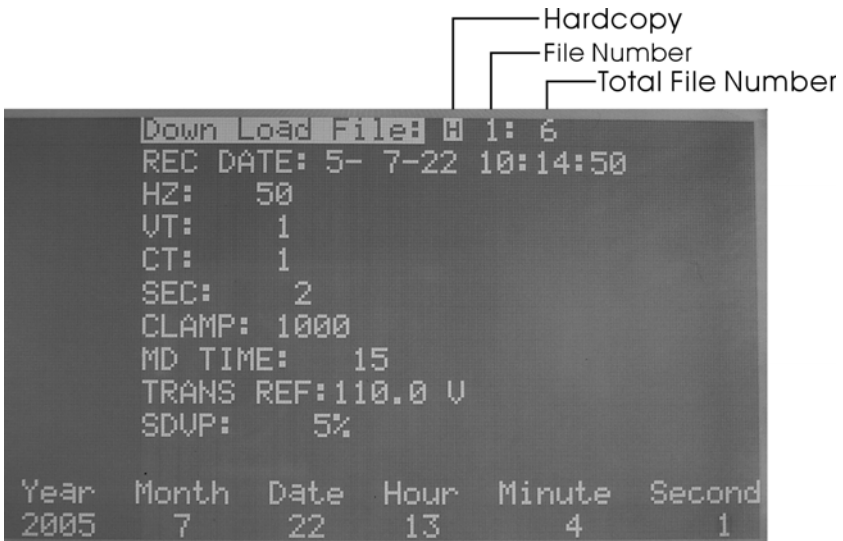

1. Press the **SETUP** button. The DOWN LOAD FILE is displayed in reverse video. If the data in the selected file is hardcopy of screen, a leading symbol of **H** is displayed in reverse video.
2. Press the **▲** or **▼** to select the saved screen.
3. Press the **HOLD/READ** button, then the saved screen will be restored.

NOTE:

If the data saved in a specific file is a **HARDCOPY** of screen, a leading symbol of **H** is displayed in reverse video.

NOTE:

Hardcopy data can not be down loaded.

VI. SET THE CT AND VT RATIO

```
Down Load File: 1:19
REC DATE: 5- 7-22 10:14:50
HZ: 50
UT: 1
CT: 1
SEC: 2
CLAMP: 100
MD TIME: 15
TRANS REF:110.0 U
SDUP: 5%
Year Month Date Hour Minute Second
2005 7 22 13 22 20
```

```
Down Load File: 1:19
REC DATE: 5- 7-22 10:14:50
HZ: 50
VT: 1
CT: 1
SEC: 2
CLAMP: 100
MD TIME: 15
TRANS REF:110.0 U
SDUP: 5%
Year Month Date Hour Minute Second
2005 7 22 13 22 9
```

Press the **SETUP** button several times until CT or VT is shown in reverse video.

Press the ▲ or ▼ button to increment or decrement the value by 1. Holding the ▲ or ▼ button will speed up the process of incrementing or decrementing. To exit, press the EXIT button.

The range of CT ratio is from 1 to 600. The range of VT ratio is from 1 to 3000.

Once the CT or VT is set, the voltage and current readings becomes

CURRENT (displayed) = CURRENT (measured) x CT Ratio

VOLTAGE (displayed) = VOLTAGE (measured) x VT Ratio

VII. SET THE TIME INTERVAL FOR MAXIMUM DEMAND

```
Down Load File: 1:19
REC DATE: 5- 7-22 10:14:50
HZ:      50
VT:      1
CT:      1
SEC:     2
CLAMP:   100
MD TIME: 15
TRANS REF:110.0 V
SDUP:    5%

Year  Month  Date  Hour  Minute  Second
2005   7    22   13    22     55
```

Press the **SETUP** button several times until MD TIME is displayed in reverse video.

Press the **▲** or **▼** buttons to increment or decrement the value by 1. Holding the **▲** or **▼** buttons will speed up the process of incrementing or decrementing. To exit, press the EXIT button.

The range of MD time interval is from 1 to 60 minutes. Once the time interval is set, the unit will calculate the maximum demand and average demand in wattage (W) or VA. To toggle between W and VA, press the **POWER** button.

VIII. SET THE SAMPLING TIME FOR DATA LOGGING

```
Down Load File: 1:19
REC DATE: 5- 7-22 10:14:50
HZ:      50
VT:      1
CT:      1
SECB    2
CLAMP:   100
MD TIME: 15
TRANS REF:110.0 U
SDUP:    5%

Year  Month  Date  Hour  Minute  Second
2005   7     22   13    22     25
```

Press the **SETUP** button several times until SEC is displayed in reverse video.

Press the **▲** or **▼** buttons to increment or decrement the value (users can set up the sampling time from 2 sec. to 3000 sec., step by 2, e.g. 2 sec., 4 sec., 6 sec., ...). Holding the **▲** or **▼** buttons will speed up the process of incrementing or decrementing.

To exit, press the **EXIT** button.

The example about how to decide the sampling time for data logging:

If users want to log data for **3 weeks** and the power system is **3P4W**, first clear the memory of the analyzer, then set up the sampling time as 104 sec. or more. See the calculation on below:

$$3 \text{ (weeks)} \times 7 \text{ (days)} \times 24 \text{ (hours)} \times 60 \text{ (min.)} \times 60 \text{ (sec.)} = 1,814,400 \text{ (sec.)}$$

$$1,814,400 \text{ (sec.)} / 17,474 \text{ (the max. file capacity of 3P4W)} = 103.83 \text{ (sec.)}$$

IX. SET THE CALENDER CLOCK

```
Down Load File: 1:19
REC DATE: 5- 7-22 10:14:50
HZ: 50
VT: 1
CT: 1
SEC: 2
CLAMP: 100
MD TIME: 15
TRANS REF:110.0 U
SDUP: 5%
Year  Month  Date  Hour  Minute  Second
2005   7     22   13    23     20
```

```
Down Load File: 1:19
REC DATE: 5- 7-22 10:14:50
HZ: 50
VT: 1
CT: 1
SEC: 2
CLAMP: 100
MD TIME: 15
TRANS REF:110.0 U
SDUP: 5%
Year  Month  Date  Hour  Minute  Second
2005   7     22   13    23     33
```

```
Down Load File: 1:19
REC DATE: 5- 7-22 10:14:50
HZ: 50
VT: 1
CT: 1
SEC: 2
CLAMP: 100
MD TIME: 15
TRANS REF:110.0 U
SDUP: 5%
Year  Month  Date  Hour  Minute  Second
2005   7     22   13    23     40
```

```
Down Load File: 1:19
REC DATE: 5- 7-22 10:14:50
HZ: 50
VT: 1
CT: 1
SEC: 2
CLAMP: 100
MD TIME: 15
TRANS REF:110.0 U
SDUP: 5%
Year  Month  Date  Hour  Minute  Second
2005   7     22   13    23     52
```

```
Down Load File: 1:19
REC DATE: 5- 7-22 10:14:50
HZ: 50
VT: 1
CT: 1
SEC: 2
CLAMP: 100
MD TIME: 15
TRANS REF:110.0 U
SDUP: 5%
Year  Month  Date  Hour  Minute  Second
2005   7     22   13    24     0
```

1. Press the SETUP button to select (Year, Month, Date, Hour, Minute).
2. Press the ▲ or ▼ buttons to increment or decrement the number.

NOTE:

Second can not be adjusted.

X. PROTOCOL OF RS-232C INTERFACE

RS-232C Interface:

Baud Rate 9600

Data bits 8

Stop bit 1

No Parity

XI. SPECIFICATIONS (23°C ± 5°C)

AC Watt

(50 or 60 Hz, PF 0.5 to 1, CT = 1, Voltage > AC 20V, Current > AC 40mA for 1A range, Current > AC 0.4A for 10A range, Current > AC 4A for 100A range, and continuous waveform)

PCE-830 + PCE-6801 (100A)

Range (0 to 100A)	Resolution	Accuracy of Readings ¹
5.0 – 999.9 W	0.1W	±1% ± 0.8W
1.000 – 9.999 KW	0.001 KW	±1% ± 8W
10.00 – 99.99 KW	0.01 KW	±1% ± 80W
100.0 – 999.9 KW	0.1 KW	±1% ± 0.8KW
1000 – 9999 KW	1 KW	±1% ± 8KW

(50 or 60 Hz, PF 0.5 to 1, CT = 1, Voltage > AC 20V, Current > AC 0.4A for 10A range, Current > AC 4A for 100A range, Current > AC 40A for 1000A range, and continuous waveform)

PCE-830 + PCE-6802 (1000A)

Range (0 to 1000A)	Resolution	Accuracy of Readings ²
5.0 – 999.9 W	0.1W	±1% ± 0.8W
1.000 – 9.999 KW	0.001 KW	±1% ± 8W
10.00 – 99.99 KW	0.01 KW	±1% ± 80W
100.0 – 999.9 KW	0.1 KW	±1% ± 0.8KW
1000 – 9999 KW	1 KW	±1% ± 8KW
0.000 – 9.999MW	0.001MW	±1% ± 80KW

(50 or 60 Hz, PF 0.5 to 1, CT = 1, Voltage > AC 20V, Current > AC 12A for 300A range of 3007, Current > AC 120A for 3000A range of 3007, and continuous waveform. Conductor is located at the center of flexible loop. Position sensitivity is 2% of range. External field effect of < 40A/m and 200mm from the coupling is 1% of range. Temperature coefficient is 0.02% of reading / °C)

À

PCE-830 + PCE-3007 (3000A/1200A)

Range (0 to 3000A/1200A)	Resolution	Accuracy of Readings ³	
		> 20 V and > 30A	< 20V or < 30A
10.0 – 999.9 W	0.1W	±1% of range	±2% of range
1.000 – 9.999 KW	0.001 KW	±1% of range	±2% of range
10.00 – 99.99 KW	0.01 KW	±1% of range	±2% of range
100.0 – 999.9 KW	0.1 KW	±1% of range	±2% of range

1000 – 9999 KW	1 KW	±1% of range	±2% of range
----------------	------	--------------	--------------

^{1,2,3} For CT ≠ 1, the accuracy in percentage is the same (±1%). But the additional digits should be multiplied by the CT ratio.

For example, ±0.8W becomes ±0.8W * CT ratio

Range of CT (Current Transformer) Ratio: 1 to 600

AC Apparent Power (VA, from 0.000VA to 9999 KVA):

$$VA = V \text{ r.m.s.} \times A \text{ r.m.s.}$$

AC Reactive Power (VAR, from 0.000 VAR to 9999 KVAR):

$$VAR = \sqrt{(VA^2 - W^2)}$$

AC Active Energy (mWH, WH, or KWH, from 0 mWH to 999,999 KWH)

$$WH = W * \text{Time (in hours)}$$

AC Current

(50 or 60 Hz, Auto Range, True RMS, Crest Factor < 4, CT=1)

PCE-830+PCE-6801 (Overload Protection AC 200A)

Range	Resolution	Accuracy of Readings ⁴
0.04 – 1 A	0.1mA / 1mA	±0.5% ± 0.05A
0.4 – 10 A	0.001A / 0.01A	±0.5% ± 0.05A
4 – 100 A	0.01A / 0.1A	±1.0% ± 0.5A

PCE-830+PCE-6802 (Overload Protection AC 2000A)

Range	Resolution	Accuracy of Readings ⁵
10.00A	0.001A / 0.01A	–
5A - 100.0A	0.01A / 0.1A	±0.5% ± 0.5A
50A – 1000.0 A	0.1A / 1A	±0.5% ± 5A

PCE-830+PCE-3007 (Overload Protection AC 3000A)

Range	Resolution	Accuracy of Readings ⁵
10.0 – 300.0A	0.01A / 0.1A	±1% of range
300.0 – 3000A	0.1A / 1A	±1% of range

^{4, 5, 6} For CT $\neq 1$, the accuracy in percentage is the same ($\pm 0.5\%$). But the additional digits should be multiplied by the CT ratio.

For example, $\pm 0.5A$ becomes $\pm 0.5A * CT$ ratio

AC Voltage

(50 or 60 Hz, Auto Range, True RMS, Crest Factor < 4, Input Impedance 10 M Ω , VT (PT) = 1, Overload Protection AC 800V)

Range	Resolution	Accuracy of Readings ⁷
20.0 V – 500.0 V (Phase to Neutral)	0.1 V	$\pm 0.5\% \pm 5\text{dpts}$
20.0 V – 600.0 V (Phase to Phase)		$\pm 0.5\% \pm 5\text{dpts}$

⁷ For VT (PT) $\neq 1$, the accuracy in percentage is the same ($\pm 0.5\%$). But the additional digits should be multiplied by the VT ratio.

For example, ± 5 digits becomes ± 5 digits * VT (PT) ratio

Range of VT (Voltage Transformer) Ratio: 1 to 3000

Harmonics of AC Voltage in Percentage

(1 to 99th order, minimum voltage at the 50 or 60 Hz > AC 80V. If the voltage is 0 at 50 or 60 Hz, all the percentage (%) display is 0.)

Range	Resolution	Accuracy
1 – 20 th	0.1%	$\pm 2\%$
21 – 49 th		$\pm 4\%$ of reading $\pm 2.0\%$
50 – 99 th		$\pm 6\%$ of reading $\pm 2.0\%$

Harmonics of AC Voltage in Magnitude

(1 to 99th order, minimum voltage at the 50 or 60 Hz > AC 80V, VT=1)

Range	Resolution	Accuracy
1 – 20 th	0.1V	$\pm 2\% \pm 0.5V$
21 – 49 th		$\pm 4\%$ of reading $\pm 0.5V$
50 – 99 th		$\pm 6\%$ of reading $\pm 0.5V$

Harmonics of AC Current in Percentage

(1 to 99th order. Min. current at 50 or 60 Hz is: ÚÛÛÛÛÛ30+ÚÛÛÛÛÛ6801 > 10% of the range; ÚÛÛÛÛÛ30+ÚÛÛÛÛÛ6802 > 20A; ÚÛÛÛÛÛ30+PCE-3007 > 30A. If the current is 0 at 50 or 60 Hz, all the percentage (%) display is 0)

PCE-830+PCE-6801

Range	Resolution	Accuracy
1 – 10 th	0.1%	±0.2% of reading ± 1%
11 – 20 th		±2% of reading ± 1%
21 – 50 th (A range)		±5% of reading ± 1%
21 – 50 th (mA range)		±10% of reading ± 1%
51 - 99 th		±35% of reading ± 1%

PCE-830+PCE-6802

Range	Resolution	Accuracy
1 – 20 th	0.1 %	±2%
21 – 49 th		±4% of reading ± 2.0%
50 – 99 th		±6% of reading ± 2.0%

PCE-830 + PCE-3007

Range	Resolution	Accuracy
1 – 20 th	0.1%	±2%
21 st – 50 th	0.1%	±6%
51 st – 99 th	0.1%	±10%

Harmonics of AC Current in Magnitude

(1 to 99th order. Min. current at the 50 or 60 Hz: ÚÛÛÛÛÛ30+ÚÛÛÛÛÛ6801 > 10% of the range; ÚÛÛÛÛÛ30+ÚÛÛÛÛÛ6802 > 20A. CT=1)

PCE-830+PCE-6801

Range	Resolution	Accuracy
1 – 10 th	0.1mA / 0.1A	±0.2% of reading ±7dgts
11 – 20 th		±2% of reading ±7dgts
21 – 50 th (A range)		±5% of reading ±7dgts
21 – 50 th (mA range)		±10% of reading ±7dgts
51 - 99 th		±35% of reading ±7dgts

PCE-830+PCE-6802

Range	Resolution	Accuracy
1 – 20 th	0.1A	±2% of reading ±0.4A
21 – 49 th		±4% of reading ±0.4A
50 – 99 th		±6% of reading ±0.4A

(1 to 99th order, min. current at the 50 or 60 Hz, True RMS < 300A for 3007, True RMS)

PCE-830+PCE-3007

Range (0 – 300A for 3007) (0 – 120A for 3009)	Resolution	Accuracy
1 – 20 th	0.1%	±2% of reading ± 4A
21 st – 50 th	0.1%	±4% of reading ± 4A
51 st – 99 th	0.1%	±6% of reading ± 4A

(1 to 99th order, min. current at the 50 or 60 Hz, 3000A > True RMS > 300A for 3007, 1200A > True RMS)

PCE-830+PCE-3007

Range (300 – 3000A for 3007) (120 – 1200A for 3009)	Resolution	Accuracy
1 – 20 th	0.1%	±2% of reading ± 40A
21 st – 50 th	0.1%	±4% of reading ± 40A
51 st – 99 th	0.1%	±6% of reading ± 40A

Power Factor (PF)**PCE-830+PCE-6801 or PCE-830+PCE-6802**

Range	Resolution	Accuracy
0.00 – 1.00	0.01	± 0.04

PCE-830+PCE-3007

Range	Resolution	Accuracy	
		> 20V and > 30A	< 20V or < 30A
0.000 – 1.000	0.001	± 0.04	±0.1

Phase Angle (Φ)**PCE-830+PCE-6801 or PCE-830+PCE-6802**

Range	Resolution	Accuracy
-180° to 180°	0.1°	± 1°

PCE-830+3PCE-3007 (Φ, V > 20V, A > 30A)

Range	Resolution	Accuracy
-180° to 180°	0.1°	± 2°
0° to 360°	0.1°	± 2°

Peak Value

of **ACV** (peak value > 20V) or **ACA** (peak value: $\hat{U}_{00E830} + \hat{U}_{00E6801} > 10\%$ of the

range; model PCE-830+PCE-6802 > 20A; model PCE-830+PCE-3007 > 30A), VT=1

Range	Sampling Time	Accuracy of Reading
50 Hz	19µs	± 5% ± 30 digits
60 Hz	16µs	± 5% ± 30 digits

Crest Factor (C.F.)

of ACV (peak value >20V) or ACA (peak value: PCE-830+PCE-6801 > 10% of the range; model PCE-830+PCE-6802 > 20A; model PCE-830+PCE-3007 > 30A), VT=1

Range	Resolution	Accuracy of Readings
1.00 – 99.99	0.01	± 5% ± 30 digits

Frequency

in AUTO mode

PCE-830+PCE-6801 or PCE-830+PCE-6802

Range	Resolution	Accuracy
45 – 65 Hz	0.1Hz	± 0.1Hz

Frequency

of ACV (RMS value > 10V) or ACA (RMS value > 30A)

PCE-830+PCE-3007

Range	Resolution	Accuracy
45 – 65 Hz	0.1 Hz	± 0.2Hz

Total Harmonic Distortion

(THD-F with respect to the fundamental frequency, min. value at 50 or 60 Hz is voltage > AC 80V and current is: ÚÛÛÛB30A+ÚÛÛÛB801> 10% of the range; ÚÛÛÛB30+ÚÛÛÛB802> 20A; ÚÛÛÛB30+ÚÛÛÛB3007> 30A. Calculation is done over 1 to 50th Harmonics. If the voltage or current is 0 at 50 or 60 Hz, all the percentage (%) display is 0).

PCE-830 + PCE-6801

Range	Resolution	Accuracy
0.0 – 20.0 %	0.1%	± 1%
20.0 – 100%		±3% of reading ± 5%
100 – 999.9%		±10% of reading ±10%

PCE-830 + PCE-6802

Range	Resolution	Accuracy
0.0 – 20%	0.1%	± 2%
20 – 100%		± 6% of reading ± 1%
100 – 999.9 %		± 10% of reading ± 1%

PCE-830 + PCE-3007

Range	Resolution	Accuracy
0.0 – 20%	0.1%	± 2%
20 – 100%	0.1%	± 6% of reading ± 5%
100 – 999.9 %	0.1%	± 10% of reading ± 10%

GENERAL SPECIFICATIONS

PCE-830 Analyzer

Indoors Use

Battery Type: 1.5V SUM-3 x 8

External DC Input: **Use only power supply adapter Model PHAPSA**

Display: Dot Matrix LCD (240x128) with backlight

LCD Update Rate: 1 time / second

Power Consumption: 140mA (approx.)

No. Of Samples: 1024 samples / period

Data Logging Files: 85

Max. File Capacity: 17474 records (3P4W, 3P3W)

26210 records (1P3W)

52420 records (1P2W)

4096 records (50 Harmonics / record)

Sampling Time: 2 to 3000 seconds for data logging

Low battery Indication:



Overload Indication: OL

Operating Temperature: -10°C to 50°C

Operating Humidity: less than 85% relative

Storage Temperature: -20°C to 60°C

Storage Humidity: less than 75% relative

Dimension: 257(L) x 155(W) x 57(H) mm

10.1"(L) x 6.1"(W) x 2.3"(H)

Weight: 1160g (Batteries included)

Accessories: Test leads (3 meter long) x 4

Probes (ÚÒÒÈ801 or ÚÒÒÈ802 or ÚÒÒÈ8007) x 3

Alligator clips x 4

Carrying bag x 1

Users manual x 1

Batteries 1.5V x 8

Software CD x 1

Software users manual x 1

USB to RS232 cable x 1

AC power adapter x 1

PCE-6801 Current Probe (100A)

Conductor Size:	30mm (approx.)
Range Selection:	Manual (1A, 10A, 100A)
Cable Length:	3000mm
Battery:	powered by power analyzer
Dimension:	210mm (L) x 62mm (W) x 36mm (H) 8.3" (L) x 2.5" (W) x 1.4" (H)
Weight:	200g

PCE-6802 Current Probe (1000A)

Conductor Size:	55mm (approx.), 64 x 24mm (bus bar)
Range Selection:	Manual (10A, 100A, 1000A)
Cable Length:	3000mm
Battery:	powered by power analyzer
Dimension:	244mm (L) x 97mm (W) x 46mm (H) 9.6" (L) x 3.8" (W) x 1.8" (H)
Weight:	600g

PCE-3007 Flexible Current Probe (3000A)

Probe Length:	3007-24	24 in / 610 mm
Minimum Bending Diameter:		35mm
Connector Diameter:		23mm
Cable Diameter:		14mm
Cable Length from Probe to Box:		1700mm
Cable Length from Box to Output:		1700mm
Range Selection:		Manual (300A, 3000A)
Battery:		powered by power analyzer
Dimension (Box):		130mm(L) x 80mm(W)x 43mm(H) 5.1"(L) x 3.1"(W) x 1.7"(H)
Weight:		410g

XII. BATTERY REPLACEMENT

When the low battery symbol is displayed on the LCD, replace the old batteries with eight new batteries.

U12:	0.0 V	U1:	0.0 V	I1:	0.0 A
U23:	0.0 V	U2:	0.0 V	I2:	0.0 A
U31:	0.0 V	U3:	0.0 V	I3:	0.0 A
<hr/>					
P1:	0.0KW	S1:	0.0KVA	Q1:	0.0KVAR
P2:	0.0KW	S2:	0.0KVA	Q2:	0.0KVAR
P3:	0.0KW	S3:	0.0KVA	Q3:	0.0KVAR
<hr/>					
PE:	0.0KW	SE:	0.0KVA	QE:	0.0KVAR
PFΣ: 0.00 PF1: 0.00 PF2: 0.00 PF3: 0.00					
PFH: 0.00 ϕ1: 0.0° ϕ2: 0.0° ϕ3: 0.0°					
<hr/>					
WH: 0.0KWH		SH: 0.0KVAH		QH: 0.0KVARH	
HZ: 60.0		MD: VA MD:		W -15	
3ϕ4W		SEC: 2 CT: 1 UT: 3		REC 0	



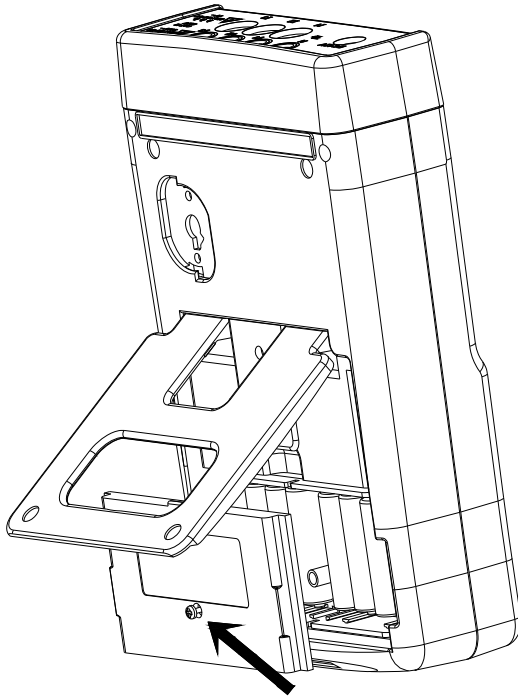

Turn the power off and remove all the test leads and current probes from the unit.

1. Remove the screw of the battery cover.
2. Lift and remove the battery cover.
3. Remove the old batteries.
4. Insert eight new 1.5V SUM-3 batteries.
5. Replace the battery cover and secure the screw.

XIII. MAINTENANCE & CLEANING

Servicing not covered in this manual should only be performed by qualified personnel. Repairs should only be performed by qualified personnel. Periodically wipe the case with a damp cloth and detergent; do not use abrasives or solvents.

For flexible probes (PCE-3007):

Always inspect the flexible current probe for any damage. If any damage is found, do not use the flexible current probe. Return the probe to a qualified person for repair or replacement.

XIV. NOMENCLATURE

V12, V23, V31: Line Voltage

V1, V2, V3: Phase Voltage

I1, I2, I3: Line Current

P1, P2, P3: True Power (W) of Each Phase

S1, S2, S3: Apparent (VA) Power of Each Phase

Q1, Q2, Q3: Reactive Power (VAR) of Each Phase

$P\Sigma$: Total System Power (W)

$S\Sigma$: Total System Apparent Power (VA)

$Q\Sigma$: Total System Reactive Power (VAR)

$PF\Sigma$: Total System Power Factor (PF)

PF1, PF2, PF3: Power Factor of Each Phase

PFH: Long Term Average Power Factor (WH / SH)

Φ 1, Φ 2, Φ 3: Phase Angle of Each Phase

WH: Watt Hours

SH: VA hours

QH: VAR hours

HZ: Selected Frequency 50, 60 or Auto.

MD: Maximum Demand in W and VA over Specified Interval

3P4W: 3 Phase 4 Wire System

3P3W: 3 Phase 3 Wire System

1P2W: Single Phase 2 Wire System

1P3W: Single Phase 3 Wire System

SEC: sampling interval in seconds from 2 to 3000 for data logging

CT: Current Transformer Ratio from 1 to 600

VT: Voltage Transformer Ratio from 1 to 3000