



User Manual

PCE-HWA 30 Anemometer



User manuals in various languages (français, italiano, español, português, nederlands, türk, polski, русский, 中文) can be found by using our product search on: www.pce-instruments.com

Last change: 30 December 2021
v1.0



Contents

1	Safety notes	1
2	Specifications	2
3	Delivery scope	2
4	Device description	3
4.1	Display description	5
4.2	Numeric keypad	6
5	Switching the meter on and off	6
5.1	Automatic power off	6
6	Making a measurement	7
6.1	Beaufort scale	8
6.2	Setting the flow unit	8
6.3	Setting the temperature unit	8
7	Volume flow measurement	8
7.1	Setting the unit of the volume flow measurement	8
7.2	Area specification for volume flow measurement	9
7.3	2/3 MAX volume flow measurement	9
8	Lowest, highest and average measured value	9
8.1	Highest measured value	9
8.2	Average reading	10
8.3	Lowest measured value	10
8.4	Freeze measured value	10
8.5	Recording the measured values	11
9	Software	12
10	Contact	16
11	Disposal	16

1 Safety notes

Please read this manual carefully and completely before you use the device for the first time. The device may only be used by qualified personnel and repaired by PCE Instruments personnel. Damage or injuries caused by non-observance of the manual are excluded from our liability and not covered by our warranty.

- The device must only be used as described in this instruction manual. If used otherwise, this can cause dangerous situations for the user and damage to the meter.
- The instrument may only be used if the environmental conditions (temperature, relative humidity, ...) are within the ranges stated in the technical specifications. Do not expose the device to extreme temperatures, direct sunlight, extreme humidity or moisture.
- Do not expose the device to shocks or strong vibrations.
- The case should only be opened by qualified PCE Instruments personnel.
- Never use the instrument when your hands are wet.
- You must not make any technical changes to the device.
- The appliance should only be cleaned with a damp cloth. Use only pH-neutral cleaner, no abrasives or solvents.
- The device must only be used with accessories from PCE Instruments or equivalent.
- Before each use, inspect the case for visible damage. If any damage is visible, do not use the device.
- Do not use the instrument in explosive atmospheres.
- The measurement range as stated in the specifications must not be exceeded under any circumstances.
- Non-observance of the safety notes can cause damage to the device and injuries to the user.

We do not assume liability for printing errors or any other mistakes in this manual.

We expressly point to our general guarantee terms which can be found in our general terms of business.

If you have any questions please contact PCE Instruments. The contact details can be found at the end of this manual.

2 Specifications

Unit	Measurement range	Resolution	Accuracy
Wind speed			
m/s	0.3 ... 30.0 m/s	0.01 m/s	±3 % ±0.1 m/s of reading
ft/min	60 ... 8800 ft/min	0.01, 0.1, 1 ft/min	±3 % ±20 ft/min of reading
knots	0.6 ... 88.0 knots	0.01 knots	±3 % ±0.2 knots of reading
km/h	1.0 ... 140.0 km/h	0.01 km/h	±3 % ±0.4 km/h of reading
mph	0.7 ... 100 mph	0.01 mph	±3 % ±0.2 mph of reading
Volume flow			
CMM (m³/min)	0 ... 999900 m³/min	0.001 ... 100 m³/min	
CFM (FT³/min)	0 ... 999900 ft³/min	0.001 ... 100 m³/min	
Temperature measurement			
°C	0 ... 45 °C	0.1 °C	±1.0 °C
°F	32 ... 113 °F	0.18 °F	±1.8 °F
Further specifications			
Probe length	270 ... 990 mm / 10.63 ... 38.98", telescopic		
Interface	Micro USB		
Data storage	960 measured values		
Power supply	4 x 1.5 V AAA battery		
Power consumption	15 ... 20 mA without backlight 20 ... 25 mA with backlight 0 ... 8 µA standby		
Flat battery indicator	<4.5 V		
Operating conditions	0 ... 50 °C / 32 ... 122 °F, 40 ... 80 % RH, non-condensing		
Storage conditions	-20 ... 60 °C / -4 ... 140 °F, <80 % RH, Non-condensing		
Dimensions	70 x 194 x 35 mm / 2.7 x 7.6 x 1.3"		
Weight	400 g / 14 oz		

3 Delivery scope

- 1 x anemoeter PCE-HWA 30
- 1 x micro USB cable
- 1 x carrying case
- 1 x user manual

4 Device description

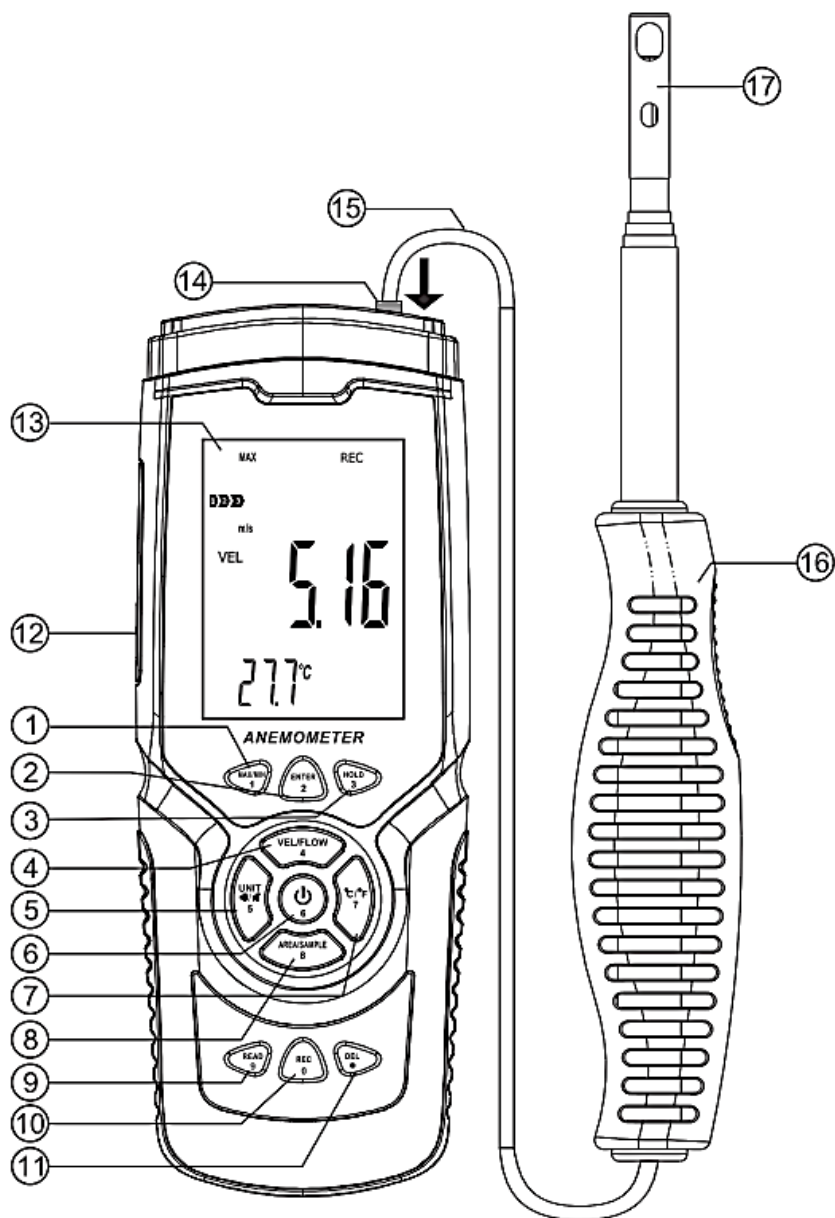

No.	Description
1	Shift key between: <ul style="list-style-type: none"> - MAX: highest measured value - AVG: average measured value - MIN: lowest measured value Numeric keypad digit: 1
2	Enter key (ENTER) 2/3 V Max key Wind direction calibration key Numeric keypad digit: 2
3	Freeze display (HOLD) Numeric keypad digit: 3
4	Select between wind speed and volume flow Numeric keypad digit: 4
5	Unit switch key (UNIT) (short press) Switching the key tone on and off (long press) Numeric keypad digit: 5
6	On-off switch (long press) Numeric keypad digit: 6
7	Setting the temperature unit (short press) Select between temperature and humidity display (long press) Numeric keypad digit: 7
8	Setting the area for volume flow measurement (AREA) Setting the storage interval (SAMPLE) Numeric keypad digit: 8
9	Opening the memory menu (read, save, record) Numeric keypad digit: 9
10	Saving a measured value Opening the recording menu Numeric keypad digit: 0
11	Clearing the memory Numeric keypad digit: .
12	USB interface for data transfer and battery charging
13	LC display
14	Connection for the flow sensor
15	Connection cable of flow sensor
16	Handle of flow sensor
17	Sensor technology of flow sensor

4.1 Display description

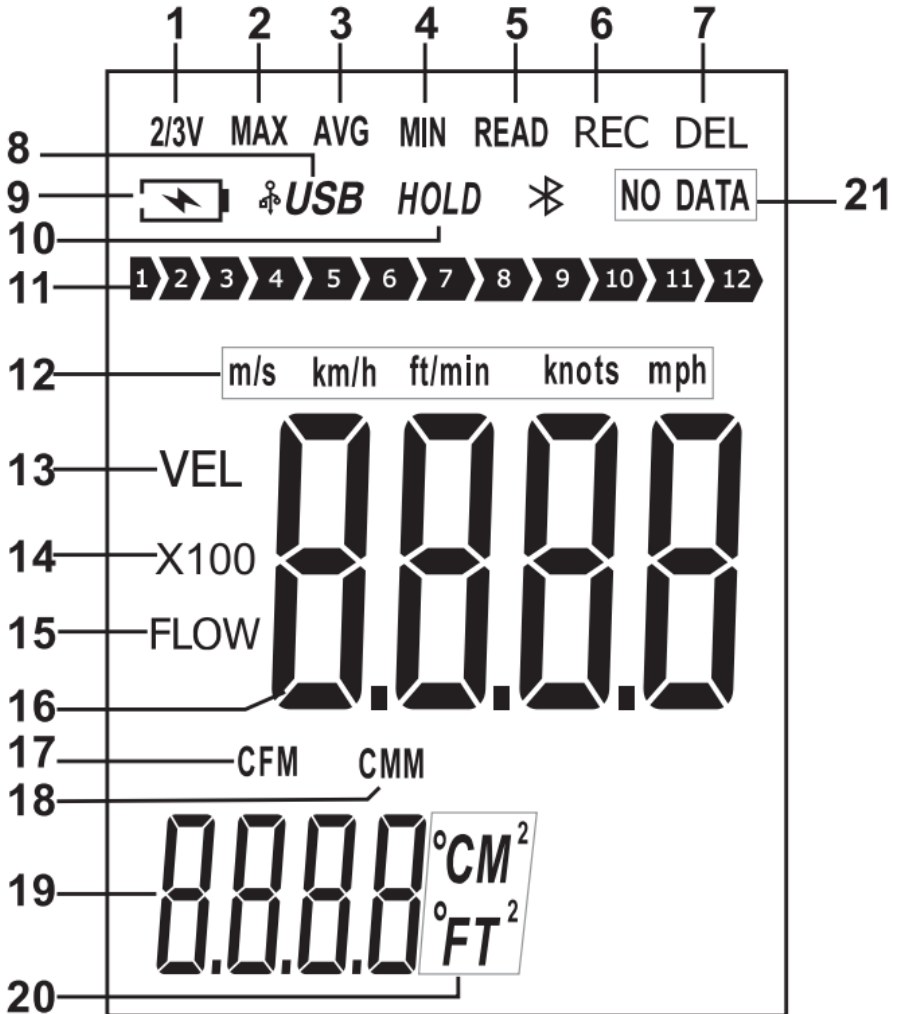

No.	Description
1	2/3 of the maximum display for volume flow measurement
2	Display of the highest measured value
3	Display of the average reading
4	Display of the lowest measured value
5	Display of the saved measured value
6	Measured value is saved
7	Clearing the memory
8	Data connection with a PC has been established
9	Battery is being charged or is discharged
10	Measured value frozen
11	Beaufort scale
12	Units for speed display
13	When displayed, the flow value is shown
14	Displayed measured value must be multiplied by 100
15	When displayed, the volume flow is shown
16	Measured value
17	Unit: CFM (FT ³ /min)
18	Unit: CMM (m ³ /min)
19	Display for temperature, area and memory
20	Unit
21	Indication that there is no saved data

4.2 Numeric keypad

It may happen that a numerical entry has to be made; for example, when entering the storage interval. To enter this function, each key changes its function to a specific numeric key. For each entry, all four cells must always be completed. A comma key is also available for volume flow measurement.

5 Switching the meter on and off

To switch the meter on and off, press and hold the on/off key for at least two seconds.

5.1 Automatic power off

If no entry is made within five minutes after switching on, the meter switches itself off. To deactivate this function, hold down the Enter key when switching on and switch on the meter. The display shows "no" The automatic power off function is now deactivated. Now release all keys to make a measurement. The automatic power off function always reactivates as soon as the meter is switched off.

6 Making a measurement

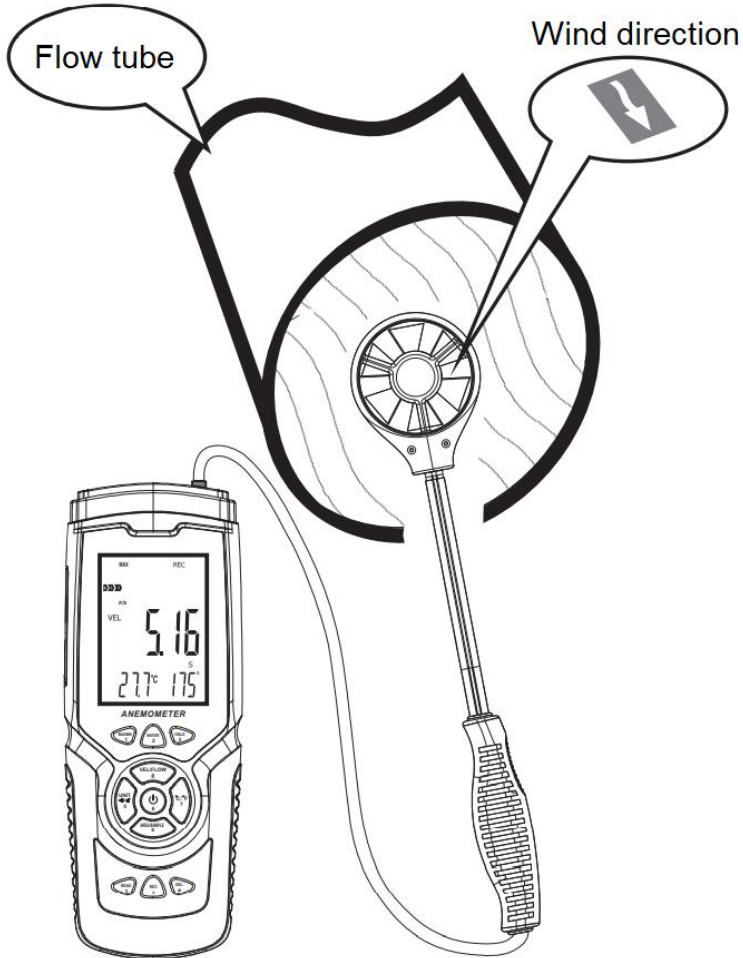

To make a measurement, align the flow sensor with the direction of the flow. An arrow on the head of the sensor indicates the orientation in relation to the wind flow. Wait for at least two seconds for the reading to stabilise.

6.1 Beaufort scale

The Beaufort scale is always active and shows the current wind force category

Wind force	Designation of the wind force	Designation of the sea state (wind sea)
0	Calm	Completely calm, smooth sea
1	Light air	Calm, rippled sea
2	Light breeze	Mildly agitated sea
3	Gentle breeze	Mildly agitated sea
4	Moderate breeze	Slightly agitated sea
5	Fresh breeze	Moderately agitated sea
6	Strong breeze	Rough sea
7	Near gale	Very rough sea
8	Gale	Moderately high seas
9	Strong gale	High seas
10	Storm	Very high seas
11	Violent storm	Heavy sea
12	Hurricane	Exceptionally heavy sea

6.2 Setting the flow unit

To set the unit of the flow velocity, press the "UNIT" key. You can choose between m/s, km/h, ft/min, knots and mps. The default setting is m/s.

6.3 Setting the temperature unit

To set the temperature unit displayed, press and release "°C/°F" once. You can choose between °C and °F. The default setting is °C.

7 Volume flow measurement

For a volume flow measurement, first press the "VEL/FLOW" key to select between velocity and volume flow measurement. This is signalled by "VEL" (speed measurement) and "FLOW" (volume flow measurement) on the display. Depending on the entered area and the measured wind flow, the measured value can also be significantly higher than it is possible to display. In this case, "x100" or "x10" is displayed next to the measured value. The measured value in the display must then be multiplied by 100 or 10 accordingly.

7.1 Setting the unit of the volume flow measurement

To select the unit FT³ or m³, press and release the "UNIT" key once.

Hint:

The function also has an effect on the area specification.

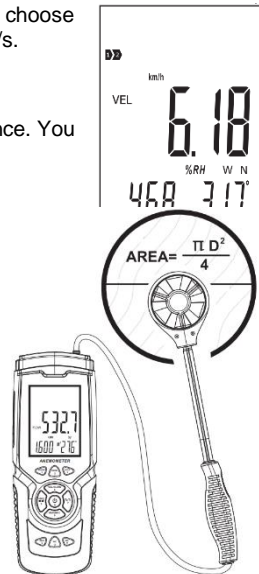

7.2 Area specification for volume flow measurement

In order to perform a volume flow measurement, it is mandatory to perform an area measurement of the flow. To do this, press the "AREA/SAMPLE" key in volume flow mode. Now enter the area. The unit of measurement m^2 or FT^2 flashes next to the display. Set the corresponding unit of measurement before entering the area.

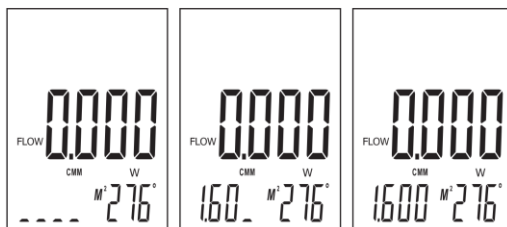

7.3 2/3 MAX volume flow measurement

During the volume flow measurement, it is possible to display 2/3 of the maximum volume flow. To do this, press the "ENTER" key. 2/3 MAX appears on the display. Only 2/3 of the maximum measured value will be displayed. Press the "ENTER" key again to exit the mode.

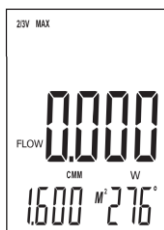

8 Lowest, highest and average measured value

For velocity and volume flow measurement, the lowest / highest and the average measured value can be displayed by pressing a key. To use these functions, repeatedly press the "MAX/MIN" key until you have reached your desired function.

8.1 Highest measured value

When displaying the highest measured value, only the highest measured value is displayed after activating this function. When "MAX" is displayed, this function is active. When the function is changed, the value expires.

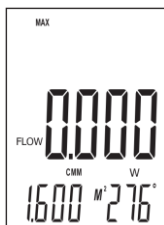

8.2 Average reading

When the average reading is displayed, the average of the last 10 seconds is displayed. With the "AVG" display, this function is active. If the function is changed, the value expires.

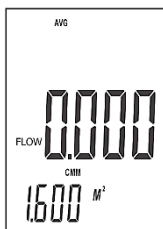

8.3 Lowest measured value

When the lowest measured value is displayed, only the lowest measured value will be displayed. When "MIN" is displayed, this function is active. If the function is changed, the value expires.

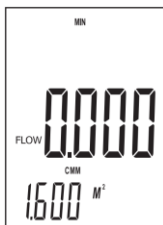

8.4 Freeze measured value

To freeze and hold the currently displayed reading, press and release the "HOLD" key once. The reading is now held. "HOLD" appears on the display. Press the "HOLD" key again to resume the measurement.

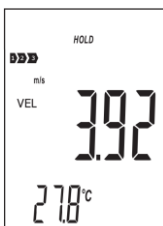

8.5 Recording the measured values

To record individual measured values, the storage interval must be set to "0000" seconds. The storage interval can only be set when the air velocity measuring function "VEL" is set. To do this, press the "SAMPLE" key and now set the storage interval accordingly. Then press the "REC" key whenever you want to save the current measured value. The memory location used is shown on the lower display and the "REC" display flashes once briefly above the display.

For continuous recording, set a desired storage interval with the "SAMPLE" key. You can select between 1 ... 9999 seconds. Then press the "REC" key once. The lower display briefly shows the storage interval. REC" is shown above the display. This signals that the measured values are being recorded. To interrupt saving, keep the "REC" key pressed. If you press the "REC" key again, recording will be restarted.

Date and time are only saved when recording with the software.

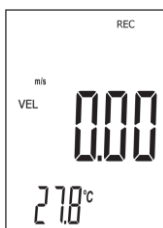

8.5.1 Read out data memory

To read out the data memory on the meter, press and release the "READ" key once. "READ" is now shown above the display. All readings displayed are now those from the memory. Each time you press the "READ" key, the next memory value is displayed. Now press the "AREA/SAMPLE" key and type in the memory location you want to read out. To return to normal measuring mode, keep the "READ" key pressed until "READ" disappears from the display.



8.5.2 Delete data

The meter has a memory with 960 measuring points. As soon as the memory is full, "FULL" is shown on the display.

To delete the measurement data on the meter, press and hold the "DEL" key for at least two seconds until "CLA" and is displayed and "DEL" lights up. All saved data have now been deleted.

Hint:

Only the entire memory can be deleted.



9 Software











To install the software, first go to the page:

https://www.pce-instruments.com/english/download-win_4.htm

where you can download and install the latest software. Then connect the meter to the PC and open the software with administrator rights. As soon as the meter is connected to the PC, the automatic power off function is deactivated.



Button	Function
"Real Time Measure"	Live view of the measurement
"Device Storage"	Reading out the memory of the meter. The window for viewing the saved readings on the meter has an identical structure. Note: The data is only transferred when the window is opened.
"Erase Storage"	Clearing the memory of the meter. As soon as you click on this button, all measured values are immediately deleted. There is no warning in advance.

Icon	Function
 Start Measure	Start live measurement (Only for live measurement)
 Stop	Stop live measurement (Only for live measurement)
 Import	Import a saved live measurement. File format XLS
 Export	Export a current live measurement. The data is saved as XLS
 Config	Enter a company name, author and comment
 Open	Open an anemometer file: File format .ane and .xls
 Save	Save an anemometer file File format .ane and .xls This function is only available when reading out the meter
 Close RT-Measure	Close window
 Clear	Delete all displayed measured values
 Quit	Close programme
<input type="checkbox"/> Zoom all	The scaling of the current graph is adjusted so that all measured values in the current measurement period are visible in one window.



The exported data is saved in XLS format. This could look like this, for example:

	A	B	C	D	E	F	G
1	PCE						
2	Wind Velocity	Wind Flow	Temperature	Area	Time	Date	
3	1,13m/s	67,80CMM	21,7°C	1M ²			
4	1,37m/s	82,20CMM	21,7°C	1M ²			
5	0,63m/s	37,80CMM	21,7°C	1M ²			
6	1,07m/s	64,20CMM	21,7°C	1M ²			
7	1,11m/s	66,60CMM	21,7°C	1M ²			
8	1,15m/s	69,00CMM	21,8°C	1M ²			
9	0,60m/s	36,00CMM	21,7°C	1M ²			
10	0,86m/s	51,60CMM	21,8°C	1M ²			
11	0,42m/s	25,20CMM	21,8°C	1M ²			
12	0,23m/s	13,80CMM	21,8°C	1M ²			
13	0,12m/s	7,20CMM	21,8°C	1M ²			
14	0,00m/s	0,00CMM	21,8°C	1M ²			
15	0,00m/s	0,00CMM	21,8°C	1M ²			
16	0,00m/s	0,00CMM	21,8°C	1M ²			
17	0,00m/s	0,00CMM	21,8°C	1M ²			
18	0,00m/s	0,00CMM	21,8°C	1M ²			
19	0,00m/s	0,00CMM	21,8°C	1M ²			
20	0,00m/s	0,00CMM	21,9°C	1M ²			
21							
22	Author: dd				File Comments: ff		

After you have selected "Real Time Measure", a new window opens for live measurement on the PC. From here, the measurement data is transferred directly to the PC.

	Wind Velocity	Wind Flow	Temperature	Area	Time	Date
1	0,00m/s	0,000CM	20,9°C	1M²	15:00:10	12-06-2021
2	0,00m/s	0,000CM	20,9°C	1M²	15:00:11	12-06-2021
3	0,00m/s	0,000CM	20,9°C	1M²	15:00:12	12-06-2021
4	0,00m/s	0,000CM	20,9°C	1M²	15:00:13	12-06-2021
5	0,00m/s	0,000CM	20,9°C	1M²	15:00:14	12-06-2021
6	0,00m/s	0,000CM	20,9°C	1M²	15:00:15	12-06-2021
7	0,00m/s	0,000CM	20,9°C	1M²	15:00:16	12-06-2021
8	0,00m/s	0,000CM	21,0°C	1M²	15:00:17	12-06-2021
9	3,94m/s	236,400CM	21,1°C	1M²	15:00:18	12-06-2021
10	0,82m/s	49,200CM	21,0°C	1M²	15:00:19	12-06-2021
11	0,58m/s	34,800CM	21,0°C	1M²	15:00:20	12-06-2021
12	0,58m/s	35,400CM	21,0°C	1M²	15:00:21	12-06-2021
13	1,75m/s	105,000CM	21,0°C	1M²	15:00:22	12-06-2021
14	1,93m/s	115,800CM	21,0°C	1M²	15:00:23	12-06-2021
15	3,80m/s	228,000CM	21,1°C	1M²	15:00:24	12-06-2021
16	2,80m/s	168,000CM	21,1°C	1M²	15:00:25	12-06-2021
17	2,48m/s	148,800CM	21,1°C	1M²	15:00:26	12-06-2021
18	0,90m/s	54,000CM	21,1°C	1M²	15:00:27	12-06-2021
19	0,22m/s	13,200CM	21,1°C	1M²	15:00:28	12-06-2021

To set the read interval, click on "Option" and then select "Read interval(sec). In the next window, you can set the interval in seconds.

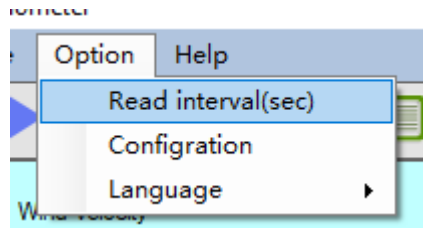

Below the window, you can see whether a meter is connected. In addition, the current window can be printed. A print preview can be started before printing. There is also a status bar for the current status of a file import.

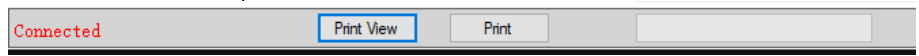



10 Contact

If you have any questions, suggestions or technical problems, please do not hesitate to contact us. You will find the relevant contact information at the end of this user manual.

11 Disposal

For the disposal of batteries in the EU, the 2006/66/EC directive of the European Parliament applies. Due to the contained pollutants, batteries must not be disposed of as household waste. They must be given to collection points designed for that purpose.

In order to comply with the EU directive 2012/19/EU we take our devices back. We either re-use them or give them to a recycling company which disposes of the devices in line with law.

For countries outside the EU, batteries and devices should be disposed of in accordance with your local waste regulations.

If you have any questions, please contact PCE Instruments.



PCE Instruments contact information

Germany

PCE Deutschland GmbH
Im Langel 26
D-59872 Meschede
Deutschland
Tel.: +49 (0) 2903 976 99 0
Fax: +49 (0) 2903 976 99 29
info@pce-instruments.com
www.pce-instruments.com/deutsch

United Kingdom

PCE Instruments UK Ltd
Unit 11 Southpoint Business Park
Ensign Way, Southampton
Hampshire
United Kingdom, SO31 4RF
Tel: +44 (0) 2380 98703 0
Fax: +44 (0) 2380 98703 9
info@pce-instruments.co.uk
www.pce-instruments.com/english

The Netherlands

PCE Brookhuis B.V.
Institutenweg 15
7521 PH Enschede
Nederland
Telefoon: +31 (0)53 737 01 92
info@pcebenelux.nl
www.pce-instruments.com/dutch

France

PCE Instruments France EURL
23, rue de Strasbourg
67250 Soultz-Sous-Forêts
France
Téléphone: +33 (0) 972 3537 17
Numéro de fax: +33 (0) 972 3537 18
info@pce-france.fr
www.pce-instruments.com/french

Italy

PCE Italia s.r.l.
Via Pesciatina 878 / B-Interno 6
55010 Loc. Gragnano
Capannori (Lucca)
Italia
Telefono: +39 0583 975 114
Fax: +39 0583 974 824
info@pce-italia.it
www.pce-instruments.com/italiano

United States of America

PCE Americas Inc.
1201 Jupiter Park Drive, Suite 8
Jupiter / Palm Beach
33458 FL
USA
Tel: +1 (561) 320-9162
Fax: +1 (561) 320-9176
info@pce-americas.com
www.pce-instruments.com/us

Spain

PCE Ibérica S.L.
Calle Mayor, 53
02500 Tobarra (Albacete)
España
Tel. : +34 967 543 548
Fax: +34 967 543 542
info@pce-iberica.es
www.pce-instruments.com/espanol

Turkey

PCE Teknik Cihazları Ltd.Şti.
Halkalı Merkez Mah.
Pehlivan Sok. No.6/C
34303 Küçükçekmece - İstanbul
Türkiye
Tel: 0212 471 11 47
Faks: 0212 705 53 93
info@pce-cihazlari.com.tr
www.pce-instruments.com/turkish