



Tursdale Technical Services Ltd  
Unit N12B  
Tursdale Business Park  
Co. Durham  
DH6 5PG  
United Kingdom  
Phone: +44 (0) 191 377 3398  
Fax: +44 (0) 191 377 3357  
[info@tursdaletechnicalservices.co.uk](mailto:info@tursdaletechnicalservices.co.uk)  
<http://www.industrial-needs.com/>

# PCE-2800 Leeb Hardness Tester

## User's Manual



---

1	Overview	3
1.1	Advantages	3
1.2	Main Application & Testing Range	3
1.2.1	Main Application	3
1.2.2	Testing Range	3
1.3	Technical Specifications	4
1.4	Configuration	5
1.5	Working Conditions	5
1.6	Safety Instructions	5
2	Structure Feature & Testing Principle	6
2.1	Structure Feature	6
2.1.1	The Hardness Tester Appearance	6
2.1.2	Parts of the Main body	6
2.1.3	D Type Impact Device	7
2.1.4	Different Types of Impact Device	7
2.2	Main Screen	7
2.3	Keypad Definitions	8
2.4	Leeb Hardness Testing Principle	9
3	Preparation	9
3.1	Instrument Preparation and Inspection	9
3.2	Impact Device Selection	9
3.3	Preparation of the Sample Surface	10
4	Testing Program	11
4.1	Start-Up	11
4.2	Loading	11
4.3	Localization	11
4.4	Testing	11
4.5	Read Measured Value	12
4.6	Notification	12
5	Operation Detail	13
5.1	Power On/Off	13
5.2	Material Setting	13
5.3	Hardness/Strength testing	14
5.4	Impact Direction Setting	14
5.5	Average Times Setting	14
5.6	Data logging	15
5.6.1	Viewing stored file/Group	15
5.6.2	Deleting selected file/Group	15
5.7	Print Function	15
5.8	System Reset	16
5.9	EL Backlight	16
5.10	Auto Power Off	16
5.11	Paper Installation	16
5.12	Battery Charge	16

5.13 Battery Replacement	17
5.14 Connecting to a Computer	17
5.15 Error Code Reference	17
6 Maintenance & Servicing	17
6.1 Impact Device Maintenance	17
6.2 Instrument Maintenance Program	18
6.3 Fault Analysis & Evacuation	18
6.4 Notice of Transport and Storage Conditions	18
APPENDIX	19
Table 1	19
Table 2	20
Table 3	21
Table 4	22

## 1 Overview

### 1.1 Advantages

- Wide measuring range. Based on the principle of Leeb hardness testing theory. It can measure the Leeb hardness of all metallic materials.
- Large screen LCD, showing all functions and parameters. With EL background light.
- Seven impact devices are available for special application. Automatically identify the type of impact devices.
- Test at any angle, even upside down.
- Direct display of hardness scales HRB, HRC, HV, HB, HS, HL.
- Large memory could store 100 groups (Relative to average times 32~1 ) information including single measured value, mean value, impact direction, impact times, material and hardness scale etc.
- Battery information showing the rest capacity of the battery and the charge status.
- User calibration function.
- Software to connect to PC via USB port.
- Thermal printer integrated, convenient for in field printing.
- NI-MH rechargeable battery as the power source. Charge circuit integrated inside the instrument. Continuous working period of no less than 150 hours (EL off and no printing).
- Auto power off to save energy.
- Outline dimensions : 212mm×80mm×32mm

### 1.2 Main Application & Testing Range

#### 1.2.1 Main Application

- Die cavity of molds
- Bearings and other parts
- Failure analysis of pressure vessel, steam generator and other equipment
- Heavy work piece
- The installed machinery and permanently assembled parts
- Testing surface of a small hollow space
- Material identification in the warehouse of metallic materials
- Rapid testing in large range and multi-measuring areas for large-scale work piece

#### 1.2.2 Testing Range

Testing range refer to Table 1 and Table 2 in the Appendix.

### 1.3 Technical Specifications

- Error and repeatability of displayed value see Table1-1 below.

Table 1-1

No.	Type of impact device	Hardness value of Leeb standard hardness block	Error of displayed value	Repeatability
1	D	760±30HLD 530±40HLD	±6 HLD ±10 HLD	6 HLD 10 HLD
2	DC	760±30HLDC 530±40HLDC	±6 HLDC ±10 HLDC	6 HLD 10 HLD
3	DL	878±30HLDL 736±40HLDL	±12 HLDL	12 HLDL
4	D+15	766±30HLD+15 544±40HLD+15	±12 HLD+15	12 HLD+15
5	G	590±40HLG 500±40HLG	±12 HLG	12 HLG
6	E	725±30HLE 508±40HLE	±12 HLE	12 HLE
7	C	822±30HLC 590±40HLC	±12 HLC	12 HLC

- Measuring range : HLD (170~960) HLD
- Measuring direction : 0°~360°
- Hardness Scale : HL、HB、HRB、HRC、HRA、HV、HS
- Display : segment LCD
- Data memory : 100 groups max. (relative to impact times 32~1)
- Printing paper: width is □57.5±0.5□mm, diameter is 30mm.
- Battery pack: 6V NI-MH
- Battery charger: 9V/500mA
- Continuous working period□about 150 hours□With backlight off, no printing□
- Communication interface□USB1.1

## 1.4 Configuration

Table 1-2

	No.	Item	Quantity	Remarks
Standard Configuration	1	Main unit	1	
	2	D type impact device	1	With cable
	3	Standard test block	1	
	4	Cleaning brush (I)	1	
	5	Small support ring	1	
	6	Battery Charger	1	9V 500mA
	7	Paper for printing	1	
	8	Manual	1	
	9	Instrument package case	1	
Optional Configuration	11	Cleaning brush (II)	1	For use with G type impact device
	12	Other type of impact devices and support rings		Refer to Table 3 and Table 4 in the appendix.
	13	DataPro software	1	
	14	Communication cable	1	
	15			
	16			

### 1.5 Working Conditions

Working temperature : -10 ~ +50 ;

Storage temperature : -30 ~ +60 ;

Relative humidity: ≤90%;

The surrounding environment should avoid of vibration, strong magnetic field, corrosive medium and heavy dust.

### 1.6 Safety Instructions

- The instrument can only work with the specially designed battery pack and power adapter (charger) supplied by Mitech Co. LTD. Working with others may result in damage of the instrument, battery leakage, fire or even explosion.
- Do not cast the battery pack into fire and do not short circuit, disassemble or heat the battery pack, otherwise battery leakage, fire or even explosion may occur.

Do not open the cover of the paper compartment or come into contact with the heating head of the printer by hand or any part of your body to avoid burns due to high temperature when the printer is printing.

## 2 Structure Feature & Testing Principle

### 2.1 Structure Feature

#### 2.1.1 The Hardness Tester Appearance

1. Main unit

2. Impact device

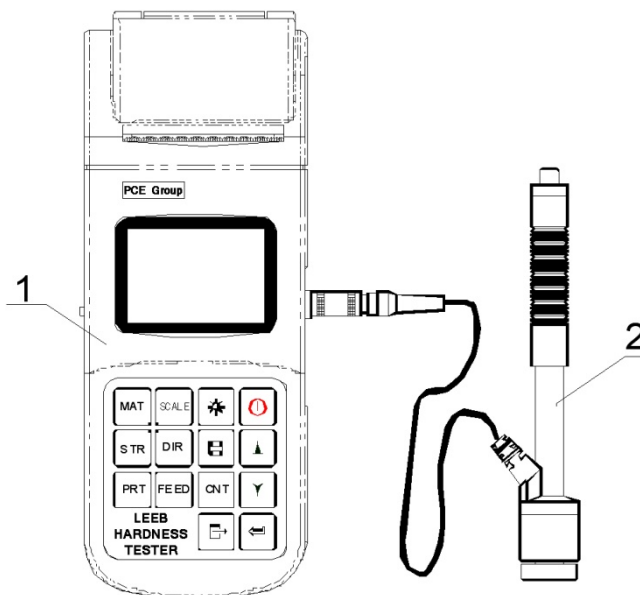

#### 2.1.2 Parts of the Main body

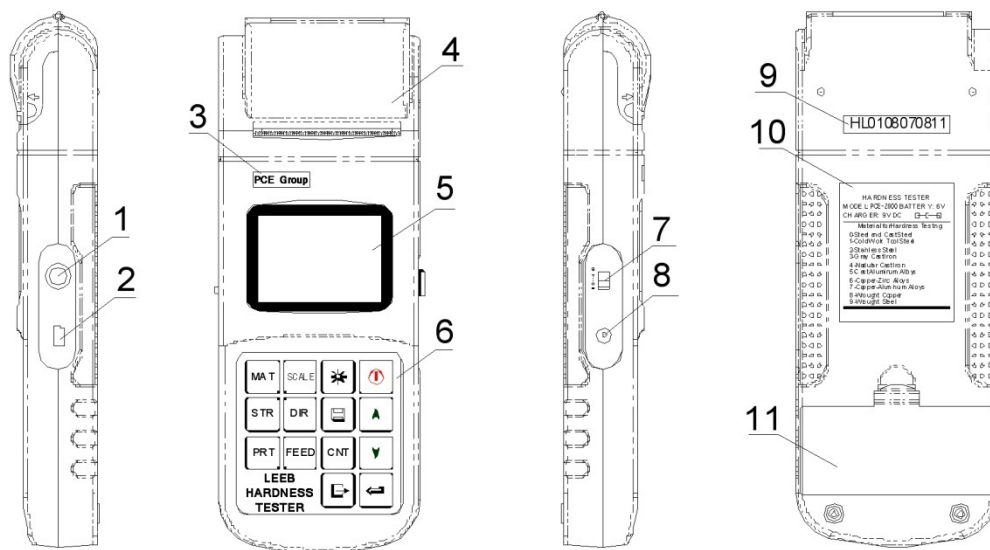

1 Socket of impact device 2 Socket of USB 3 LOGO 4 Paper compartment cover 5 LCD display 6 Keypad 7 Battery switch 8 Power jack 9 Serial Number 10 Product label 11 Battery compartment cover

### 2.1.3 D Type Impact Device

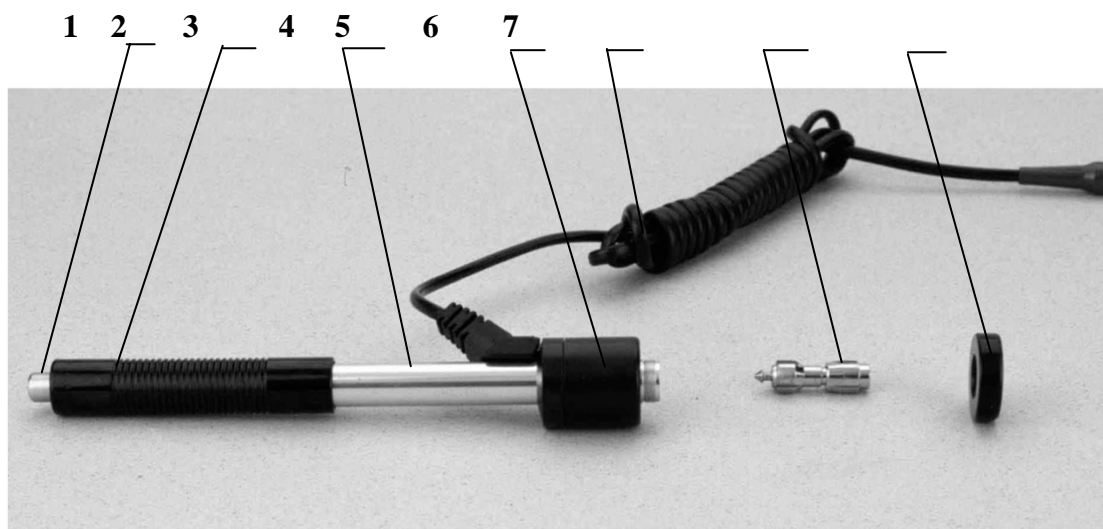

- 1 Release button    2 Loading tube    3 Guide tube    4 Coil unit
- 5 Connection cable    6 Impact body    7 Support ring

### 2.1.4 Different Types of Impact Device

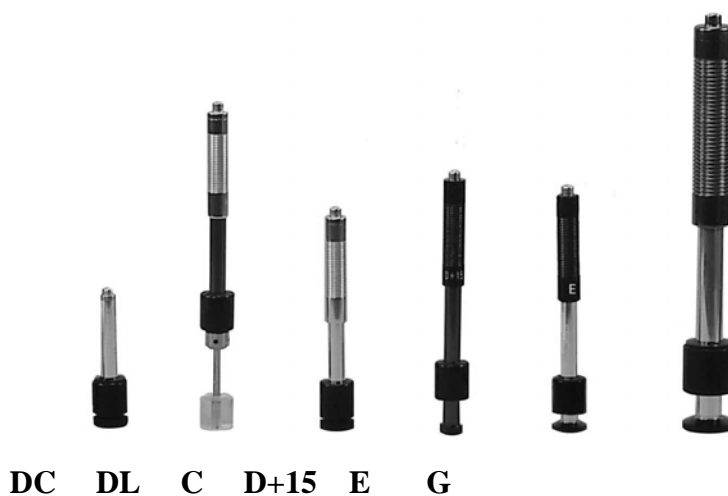

### 2.2 Main Screen

Below is the main display screen:

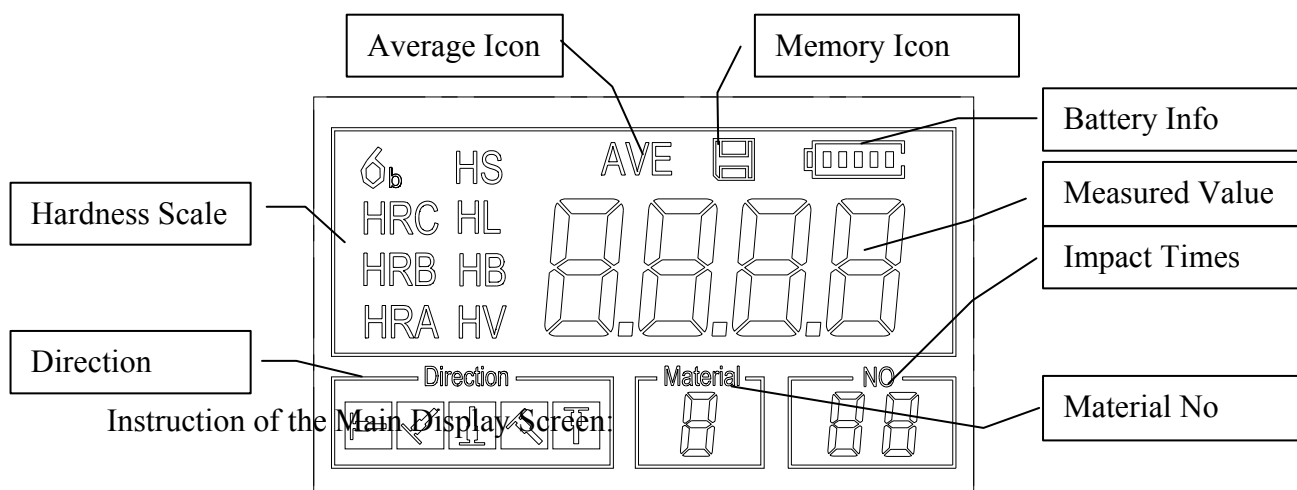



**Material** : The present presetting material.

**Impact direction** : The present impact direction.

**Hardness scale** : Hardness scale of the present measured value.

**Battery information** : Showing the rest capacity of the battery and the charging status.

**Measured value** : Display present single time measured value (without showing average icon) , or display the present mean value (with average icon prompting). “-HI-” means over conversion value or measure range. “-LO-” means lower than conversion value or measure range.















**Impact times** : Times that have been impacted.

**Average Icon** : It will appear when showing the mean value of the measured values after reaching the presetting impact times.













**Memory Icon**: It appears when operating the instrument memory.



## 2.3 Keypad Definitions

Table 2-1

	Turn on/off the EL backlight		Data Save or Data Delete		Turn the instrument on/off
	Material Selection		Hardness/Strength switch		Plus or Up
	Hardness Scale Selection		Direction change		Minus or Down
	Manual Paper Feed		Impact Times set		
	Print data		Cancel or Exit		Data logging or Enter

Press  key to store present group of measured value into memory. This operation is only valid after displaying the mean value.

- Press key  and  could display single measured value.
- Press  key could switch on of off the background light of LCD.
- Press  key to set the impact direction.
- Press  key to change the impact times in one group. The impact times item will flash when first pressing the  key, and then the impact times value will plus or minus when pressing the  or  key. Press  key finally to exit from changing the impact times process.
- Press  key to change the hardness scale.
- Press  key to change the material. Presetting hardness scale recovers to HL automatically after material presetting changed.
- Press  key to switch between hardness test and strength test. Only D and DC type of impact device has the function of strength testing. So hardness testing is the only selection if the impact device is not D or DC type.

- Press  key to print out the measured values after measurement.
- Press  key to manually feed the paper.

## 2.4 Leeb Hardness Testing Principle

The basic principle is to use an impact body of certain weight impacts against the testing surface under certain test force, then measure the impacting velocity and the rebounding velocity of the impact body respectively when the spherically test tip is located 1mm above the testing surface.

The calculation formula is as follows:



$$HL=1000 \times VB / VA$$

Where, HL—— Leeb hardness value  
 VB—— Rebounding velocity of the impact body  
 VA—— Impacting velocity of the impact body

## 3 Preparation

### 3.1 Instrument Preparation and Inspection



Verification of the instrument is by using standard test block. The error and repeatability of displayed value should be within the regulation of Appendix table 2. The instrument and impact device must be calibrated using a standard hardness block before use as the first time, or having not been used for a long time, or having reset the instrument system.

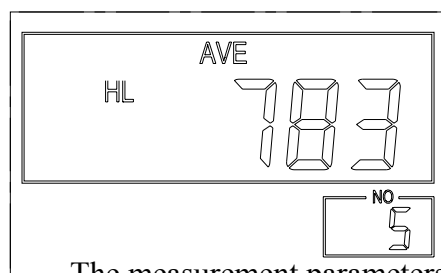

Press  key, meanwhile pressing down the  key to power on the system. Then the user calibration screen shows as left below.



The measurement parameters, including the material setting, the hardness scale and the impact direction can't be changed during calibration.

Test for 5 points on the standard hardness block.

It would display the average measured value after measuring 5 times. Press   key to change to its nominal value.

Press  key to confirm the calibration finally. Or press the  key to cancel the calibration.

Range of adjustment: ±30HL.

**Note :** Use a calibrated hardness tester, test the standard test block downward vertically for 5 times, the arithmetical average value compare with the value of standard test block. If this value exceeds the standard value, could use the function of user calibration to adjust.

3.2 Impact Device Selection

Refer to Appendix

Table 1 and Table 3 for selection of impact device.

### 3.3 Preparation of the Sample Surface

Preparation for sample surface should conform to the relative requirement in Appendix Table 3.

- In the preparation processing for sample surface, the hardness effect of being heated or cold processing on the surface of sample should be avoided.
- Too big roughness of the being measured surface could cause error. So, the surface of the sample to be measured must appear metallic luster, smoothing and polish, without oil stain.
- Support of test sample. Support is no necessary for heavy sample. Medium-weight parts must be set on the smoothing and stable plane. The sample must set absolutely equability and without any wobble.
- Curved surface: The best testing surface of sample is flat. When the curvature radius  $R$  of the surface to be tested is smaller than 30mm (D, DC, D+15,C, E and DL type of impact device) and smaller than 50mm (G type of impact device), the small support ring or the shaped support rings should be chosen.
- The sample should have enough thickness, minimum thickness of sample should conform to Table 3.
- For the sample with hardened layer on surface, the depth of hardened layer should conform to Table 3.

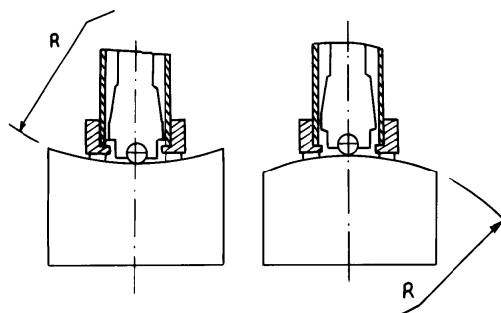

- Coupling. Light weight sample must be firmly coupled with a heavy base plate. Both coupled surface must be flat and smooth, and there is no redundant coupling agent existing. The impact direction must be vertical to the coupled surface. When the sample is a big plate, long rod or bending piece, it can be deformed and become unstable, even though its weight and thickness is big enough, and accordingly, the test value may not be accurate. So the sample should be reinforced or supported at its back.
- Magnetism of the sample itself should be avoided.

## 4 Testing Program

### 4.1 Start-Up

- Insert the plug of the impact device into the socket of impact device on the instrument.
- Press the  key, now power is on. The instrument is in working mode.

### 4.2 Loading

Pushing the loading-tube downwards until contact is felt. Then allow it to slowly return to the starting position or using other method locking the impact body.

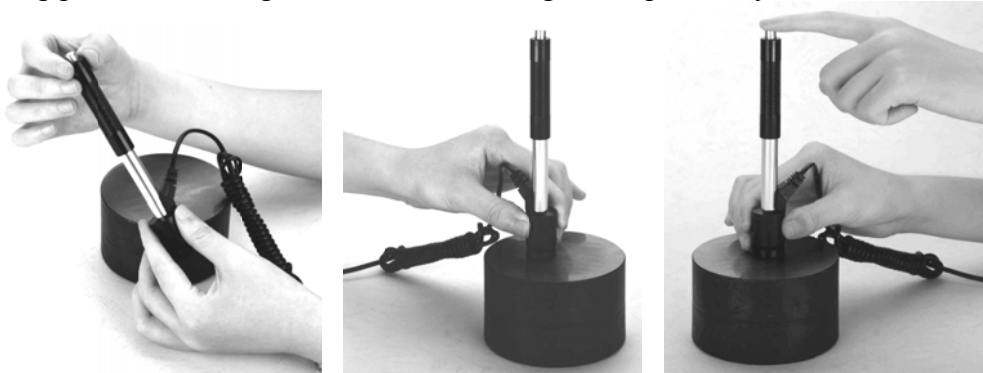

### 4.3 Localization

Press the impact device supporting ring firmly on the surface of the sample, the impact direction should be vertical to the testing surface.

### 4.4 Testing

- Press the release button on the upside of the impact device to test. The sample and the impact device as well as the operator are all required to be stable now. The action direction should pass the axis of the impact device.
- Each measure area of the sample usually need 3 to 5 times of testing operation. The result data dispersion should not more than mean value $\pm 15HL$ .
- The distance between any two impact points or from the center of any impact point to the edge of testing sample should conform to the regulation of Table 4-1.
- If want accurate conversion from the Leeb hardness value to other hardness value, contrastive test is needed to get conversion relations for the special material. Use inspection qualified Leeb hardness tester and corresponding hardness tester to test at the same sample respectively. For each hardness value, each measure homogeneously 5 points of Leeb hardness value in the surrounding of more than three indentations which need conversion hardness, using Leeb hardness arithmetic average value and corresponding hardness average value as correlative value respectively, make individual hardness contrastive curve. Contrastive curve at least should include three group of correlative data.

Table 4-1

Type of Impact Device	Distance of center of the two indentations	Distance of center of the indentation to sample edge
	Not less than (mm)	Not less than (mm)
D、 DC	3	5
DL	3	5
D+15	3	5
G	4	8
E	3	5
C	2	4

#### 4.5 Read Measured Value

After each impact operation, the LCD will display the current measured value, impact times plus one, the buzzer would alert a long howl if the measured value is not within the valid range. When reaching the presetting impact times, the buzzer will alert a long howl. After 2 seconds, the buzzer will alert a short howl, and display the mean measured value.

#### 4.6 Notification

- Replacing the impact device must be done during Power off. Otherwise the main body could not identify the type of the impact device, and it may damage the circuit board of the main body.
- You could not save the current test value if the impact time is less than the presetting times value.
- Only type D and type DC of impact device have the function of strength test option. You can not change the setting to strength testing when using other types of impact device. The setting would be set to hardness testing automatically after replacing the impact device whether the setting is hardness testing or not before.

Not all materials could convert to all hardness scale value. The hardness scale is reset to HL automatically after changing the material. So select material firstly before changing the hardness scale.

## 5 Operation Detail

### 5.1 Power On/Off

Press to power on the instrument. Be sure to plug in the impact device before powering on. The system would automatically detect the type of the impact device during power up, and would display this information on the screen. Users should pay attention to the probe type displayed on the screen. After pausing for several second, the screen will exit and enter the main display screen as following:

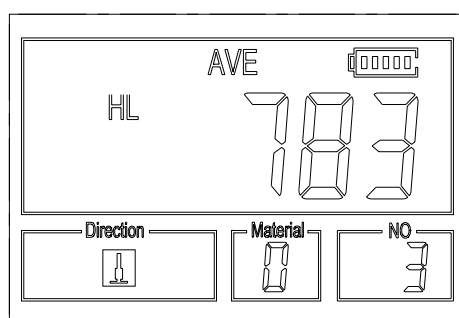

The instrument can be turned off by pressing the key while it is working. The tool has a special memory that retains all of its settings even when the power is off.

**Note: If the instrument is in power off condition, it will turns on automatically after the charge power is connected.**

### 5.2 Material Setting

Press key to change the material to the one you want to preset. Hardness scale recovers to HL automatically after material presetting changed. Please select material firstly, then select hardness scale.

In hardness testing, you can select the material among the following materials: Steel and Cast Steel, Cold Work Tool Steel, Stainless Steel, Gray Cast Iron, Nodular Cast Iron, Cast Aluminum Alloys, Copper-Zinc Alloys, Copper-Aluminum Alloys, Wrought Copper and Wrought Steel. The relationship between the material number displayed on the instrument screen and the material is as follows:

Table 5-1

Material No.	Material	Material No.	Material
0	Steel and cast steel	5	Cast aluminum alloys
1	Cold work tool steel	6	Copper-Zinc alloys
2	Stainless steel	7	Copper –Aluminum alloys
3	Gray cast iron	8	Wrought copper
4	Nodular cast iron	9	Wrought steel

In strength testing, the following materials are selectable: Mild Steel, High-Carbon Steel, Cr Steel, Cr-V Steel, Cr-Ni Steel, Cr-Mo Steel, Cr-Ni-Mo Steel, Cr-Mn-Si Steel, Super Strength Steel and Stainless Steel. The relationship between the material number displayed on the instrument screen and the material is as follows:

Table 5-2

Material No	Material	Material No	Material
0	Mild steel	5	Cr-Mo steel
1	High carbon steel	6	Cr-Ni-Mo steel
2	Cr steel	7	Cr-Mn-Si steel
3	Cr-V steel	8	Super strength steel
4	Cr-Ni steel	9	Stainless steel

### 5.3 Hardness/Strength testing

Press **STR** key to switch between hardness testing and strength testing (6b) .

**Note: Only D and DC type of impact device has the function of strength testing. So hardness testing is the only selection if the impact device is not D or DC type.**

In hardness testing, Press **SCALE** key to change the hardness scale. The supported hardness scale includes: HL, HV, HB, HRC, HS, HRB and HRA.

**Note :**

- **Here only displays the valid hardness scale for the present selected impact device and material. It would not display the hardness scale which is not valid.**
- **Please select material firstly, then select hardness scale.**
- **Presetting hardness scale recovers to HL automatically after presetting material is changed.**

### 5.4 Impact Direction Setting

Press the **DIR** key to move to the impact direction that you will preset.

### 5.5 Average Times Setting

You could modify average times within the range of 1 to 32 as following:

1) Press **CNT** key in testing state. The impact times item will begin to flash.

2) Press **↑** or **↓** key to set the average times to the number you want.







Press **CNT** key finally to exit from the operation.

## 5.6 Data logging

At most one hundred files (F00-F99, one group as one file) can be stored inside the gauge. By simply pressing the  key after a new measurement finishes-the screen showing the “AVE” icon, the measured hardness/strength group values will be saved to memory. The new saved file is appended as the last file of the memory. This function provides the user with the ability to view/delete a file/group previously saved in memory.





### 5.6.1 Viewing stored file/Group

To view the memory data, follow the steps:

- 1) Press the  key to activate the data logging function. The memory icon will appear. It will display the current file name, the test parameter of the group data and the mean value of the group. If there is no data in the memory, it will display: <E04>, which means no memory data, and then return back.
- 2) Use the  key and the  key to select the desired file to view.
- 3) Press the  key to see details of that group data.
- 4) Use the  key and the  key to view each single measured data in that group while viewing details.
- 5) Press the  key to return to previous screen at any time during data logging.

### 5.6.2 Deleting selected file/Group





The user may require deleting a file from the instrument memory. The procedure is outlined in the following steps.

- 1) Press the  key to activate the data logging function. The memory icon will appear. It will display the current file name, the test parameter of the group data and the mean value of the group. If there is no data in the memory, it will display: <E04>, which means no memory data, and then return back.
- 2) Use the  key and the  key to scroll to the file that will be deleted.
- 3) Press the  key on the desired file. It will automatically delete the file, and display “-DEL”.
- 4) Press the  key, at any time, to exit the data logging function and return to measurement mode.

**Note :** *Do not shut down the instrument while deleting data. It could lead to unpredicted consequence if shutting down while deleting.*

## 5.7 Print Function

At the end of the inspection process, or end of the day, the user may require the readings be printed. You can print out the measurement result immediately after each testing process, by easily pressing the  key. If you want to print the data stored in the instrument memory, then following is the steps:



1. Press the  key to activate the data logging function. The memory icon will appear.
2. Use the  key and the  key to select the desired file.
3. Press the  key to print the selected file. This operation will print out all the data in current file.
4. Press the  key to exit the data logging functions and return to measurement mode.

**Note:**

- *Printing function is unavailable while charging.*
- *Printing can be stopped by pressing the  key.*
- *Do not open the cover of the paper compartment during printing. Otherwise the instrument may not print normally.*
- *Over high ambient humidity (above 85% of relative humidity) or over low ambient humidity (below 20% of relative humidity) may reduce the print quality.*
- *Printing with paper that has been stored for over long period of time or of poor quality may*



**reduce the print quality or even damage the printer.**

When the printer is powered on and ready for printing, press  key then the instrument will start manual paper feeding. Press and keep holding the  key to start paper feeding, while releasing the key to stop paper feeding.

**Note: Manual paper feeding is unavailable while charging.**

### 5.8 System Reset

Press down the  key while powering on the instrument will restore factory defaults. The only time this might possibly helpful is if the parameter in the instrument was somehow corrupted.

### 5.9 EL Backlight

With the EL background light, it is convenient to work in the dark condition. Press key  to switch on or switch off the background light at any moment as you need after power on. Since the EL light will consume much power, turn on it only when necessary.

### 5.10 Auto Power Off

The instrument features an auto power off function designed to conserve battery life. If the tool is idle (neither measuring nor any key operation) for 5 minutes, it will turn itself off. Before powering off, the LCD display of the instrument will continue flashing for 20 seconds. Except key , press any key could stop the twinkle of LCD screen and stop the operation of power off at the moment.

While the voltage of the battery is too low, the display will show <E00>, then power off automatically.

When the instrument is being charged, the Auto Power Off will not function.

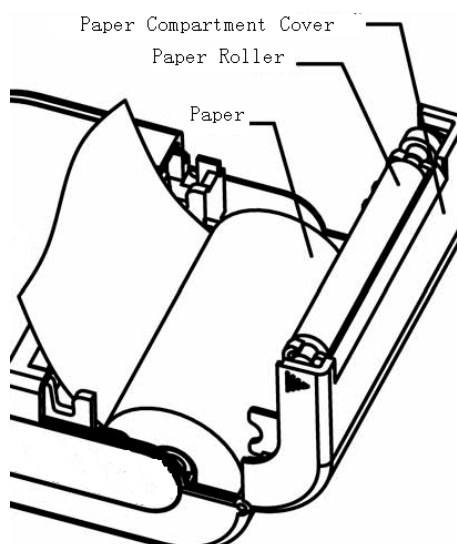

### 5.11 Paper Installation

- Hold Both ends of the paper compartment with fingers and open the compartment cover with moderate strength.
- According to the illustration, put the paper into the paper compartment with attention to the paper direction. If the paper is misplaced, the instrument will fail to print.
- Pull a trip of paper out of the compartment.
- Make sure that the paper is well in place and close the paper compartment cover.



### 5.12 Battery Charge

The instrument uses a NI-MH battery pack as its power source. When the battery pack almost runs out, the battery symbol on the display will glint . It needs charging as soon as possible. Try to drain your battery pack as fully as possible before it is charged for longest battery service.

- The battery switch should be at 'ON' condition before charging.
- Plug the power adapter into the mains supply power socket and then plug the charger connector into the power jack of the instrument. If the instrument is in power off condition, it will turn on automatically after the charger plug is inserted into the power jack. The battery symbol will alternately show between  and  when charging. The more of the dark part indicates the more close to full capacity.
- When the battery is fully charged, the battery symbol on the display will glint .
- Please use the configured AC-DC adapter to charge the battery pack.

**Warning: When the battery pack is being charged, printing or paper feeding is unavailable.**

### 5.13 Battery Replacement

When the battery pack fails to be charged, the user should replace the batteries following the program below:

- Power down the instrument.
- Take off the battery compartment cover and take out the battery pack.
- Insert the connection plug of the new battery pack into the socket on the circuit board.
- Reset the battery cover.
- Turn on the instrument to check.

**Warning: Please pay much attention to the polarity of the battery during battery replacement.**

### 5.14 Connecting to a Computer

Insert one connection plug of the transmission cable into the USB socket on the right side of main body, and insert the another plug into the USB port on the back of computer box. Refer to the manual of the DataPro software for detailed information.

### 5.15 Error Code Reference

Error Code	Explanation	Error Code	Explanation
E00	Battery exhausted	E05	Can not print
E01	Value out of range	E06	Battery Charging
E02	Measurement not finished	E07	No paper for printing
E03	Data already saved	E08	Over Temperature
E04	No memory data	E09	

## 6 Maintenance & Servicing

### 6.1 Impact Device Maintenance

- After the impact device has been used for 1000--2000 times, please use the nylon brush provided to clean the guide tube and impact body. When cleaning the guide tube, unscrew the support ring first, then take out the impact body, spiral the nylon brush in counter-clock direction into the bottom of guide tube and take it out for 5 times, and then install the impact body and support ring again.
- Release the impact body after use.
- Any lubricant is absolutely prohibited inside the impact device.

## 6.2 Instrument Maintenance Program

- When using standard Rockwell hardness block to testing, if all the error is bigger than 2 HRC, it may be the invalidation of impacted ball top caused by abrasion. Changing the spherical test tip or impact object should be considered.
- When the hardness tester appears some other abnormal phenomena, please do not dismantle or adjust any fixedly assembled parts. Fill in and present the warranty card to us. The warranty service can be carried on.

## 6.3 Fault Analysis & Evacuation

Fault Appearance	Fault Analysis	Handling method
Charge failure	Battery failure	Replace the battery with a new pack
	The battery is switched off	Switch on the battery
No measured value	Impact device cable failure	Replace the cable
Failure power on	Battery exhaustion	Charge the battery
	The battery is switched off	Switch on the battery

## 6.4 Notice of Transport and Storage Conditions

- Keep it away from vibration, strong magnetic field, corrosive medium, dampiness and dust. Storage in ordinary temperature.
- With original packing, transport is allowed on the third grade highway.

## APPENDIX

Table 1

Material	Method	Impact device					
		D/DC	D+15	C	G	E	DL
Steel and cast steel	HRC	20□68.5	19.3□67.9	20.0□69.5		22.4□70.7	20.6□68.2
	HRB	38.4□99.6			47.7□99.9		37.0□99.9
	HRA	59.1□85.8				61.7□88.0	
	HB	127□65.1	80□638	80□683	90□646	83□663	81□646
	HV	83□976	80□937	80□996		84□1042	80□950
	HS	32.2□99.5	33.3□99.3	31.8□102.1		35.8□102.6	30.6□96.8
Cold work tool steel	HRC	20.4□67.1	19.8□68.2	20.7□68.2		22.6□70.2	
	HV	80□898	80□935	100□94.1		82□1009	
Stainless steel	HRB	46.5□101.7					
	HB	85□655					
	HV	85□802					
Grey cast iron	HRC						
	HB	93□334			92□326		
	HV						
Nodular cast iron	HRC						
	HB	131□38.7			127□364		
	HV						
Cast aluminum alloys	HB	19□164		23□210	32□168		
	HRB	23.8□84.6		22.7□85.0	23.8□85.5		
BRASS(copper-zinc alloys)	HB	40□173					
	HRB	13.5□95.3					
BRONZE(copper-aluminum/tin alloys)	HB	60□290					
Wrought copper alloys	HB	45□315					

Table 2

No.	Material	HLD	Strength $\sigma_b$ (MPa)
1	Mild steel	350□522	374□780
2	High-Carbon steel	500□710	737□1670
3	Cr steel	500□730	707□1829
4	Cr-V steel	500□750	704□1980
5	Cr-Ni steel	500□750	763□2007
6	Cr-Mo steel	500□738	721□1875
7	Cr-Ni-Mo steel	540□738	844□1933
8	Cr-Mn-Si steel	500□750	755□1993
9	Super strength steel	630□800	1180□2652
10	Stainless steel	500□710	703□1676

Table 3

Type of impact device	DC(D)/DL	D+15	C	G	E	
Impacting energy	11mJ	11mJ	2.7mJ	90mJ	11mJ	
Mass of impact body	5.5g/7.2g	7.8g	3.0g	20.0g	5.5g	
Test tip hardness:	1600HV	1600HV	1600HV	1600HV	5000HV	
Dia. Test tip:	3mm	3mm	3mm	5mm	3mm	
Material of test tip:	Tungsten carbide	Tungsten carbide	Tungsten carbide	Tungsten carbide	synthetic diamond	
Impact device diameter:	20mm	20mm	20mm	30mm	20mm	
Impact device length:	86(147)/	162mm	141mm	254mm	155mm	
Impact device weight:	75mm 50g	80g	75g	250g	80g	
Max. hardness of sample	940HV	940HV	1000HV	650HB	1200HV	
Mean roughness value of sample surface Ra:	1.6µm	1.6µm	0.4µm	6.3µm	1.6µm	
Min. weight of sample:						
Measure directly	>5kg	>5kg	>1.5kg	>15kg	>5kg	
Need support firmly	2□5kg	2□5kg	0.5□1.5kg	5□15kg	2□5kg	
Need coupling tightly	0.05□2kg	0.05□2kg	0.02□0.5kg	0.5□5kg	0.05□2kg	
Min. thickness of sample Coupling tightly	5mm	5mm	1mm	10mm	5mm	
Min. layer thickness for surface hardening	≥0.8mm	≥0.8mm	≥0.2mm	≥1.2mm	≥0.8mm	
Size of tip indentation						
Hardness 300HV	Indentation diameter	0.54mm	0.54mm	0.38mm	1.03mm	0.54mm
	Depth of indentation	24µm	24µm	12µm	53µm	24µm
Hardness 600HV	Indentation diameter	0.54mm	0.54mm	0.32mm	0.90mm	0.54mm
	Depth of indentation □□□□	17µm	17µm	8µm	41µm	17µm
Hardness 800HV	Indentation diameter	0.35mm	0.35mm	0.35mm	--	0.35mm
	Depth of indentation	10µm	10µm	7µm	--	10µm
Available type of impact device	DC: Test hole or hollow cylindrical; DL: Tests slender narrow groove or hole	D+15: Test groove or reentrant surface	C: Test small, light, thin parts and surface of hardened layer	G: Test large, thick, heavy and rough surface steel	E: Test super high hardness material	

Table 4

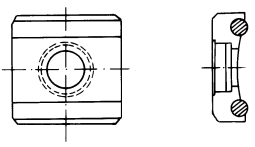
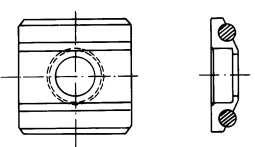
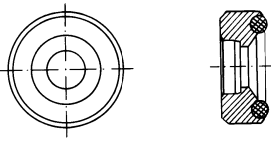
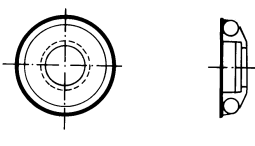
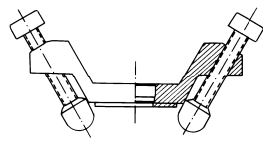
No.	Type	Sketch of non-conventional Supporting ring	Remarks
1	Z10-15		For testing cylindrical outside surface R10 □ R15
2	Z14.5-30		For testing cylindrical outside surface R14.5 □ R30
3	Z25-50		For testing cylindrical outside surface R25 □ R50
4	HZ11-13		For testing cylindrical inside surface R11 □ R13
5	HZ12.5-17		For testing cylindrical inside surface R12.5 □ R17
6	HZ16.5-30		For testing cylindrical inside surface R16.5 □ R30
7	K10-15		For testing spherical outside surface SR10 □ SR15
8	K14.5-30		For testing spherical outside surface SR14.5 □ SR30
9	HK11-13		For testing spherical inside surface SR11 □ SR13
10	HK12.5-17		For testing spherical inside surface SR12.5 □ SR17
11	HK16.5-30		For testing spherical inside surface SR16.5 □ SR30
12	UN		For testing cylindrical outside surface, radius adjustable R10 □ ∞

In this direction will find a vision of the measurement technique:  
<http://www.industrial-needs.com/measuring-instruments.htm>

**NOTE:** "This instrument doesn't have ATEX protection, so it should not be used in potentially explosive atmospheres (powder, flammable gases)."